

JSS-2150

MF/HF RADIO EQUIPMENT

**INSTRUCTION
MANUAL**

for DSC AP

JRC *Japan Radio Co., Ltd.*

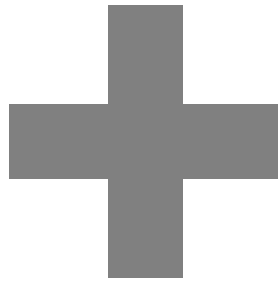

CAUTIONS AGAINST HIGH VOLTAGE

Radio and radar devices are operated by high voltages of anywhere from a few hundred volts up to many hundreds of thousands of volts. Although there is no danger with normal use, it is very dangerous if contact is made with the internal parts of these devices. (Only specialists should attempt any maintenance, checking or adjusting.)

There is a very high risk of death by even a few thousand volts, in some cases you can be fatally electrocuted by just a few hundred volts. To prevent accidents, you should avoid contact with the internal parts of these devices at all costs. If contact is inevitable as in the case of an emergency, you must switch off the devices and ground a terminal in order to discharge the capacitors. After making certain that all the electricity is discharged, only then can you insert your hand into the device. Wearing cotton gloves and putting your left hand in your pocket, in order not to use both hands simultaneously, are also very good methods of shock prevention.

Quite often, an injury occurs by secondary factors, therefore it is necessary to choose a sturdy and level working surface. If someone is electrocuted it is necessary to thoroughly disinfect the affected area and seek medical attention as soon as possible.

Cautions concerning treatment of electrocution victims

When you find an electrocution victim, you must first switch off the machinery and ground all circuits. If you are unable to cut off the machinery, move the victim away from it using a non-conductive material such as dry boards or clothing.

When someone is electrocuted, and the electrical current reaches the breathing synapses of the central nervous system inside the brain, breathing stops. If the victim's condition is stable, he or she can be administered artificial respiration. An electrocution victim becomes very pale, and their pulse can be very weak or even stop, consequently losing consciousness and becoming stiff.

Administration of first aid is critical in this situation.

First aid

☆Note points for first aid

Unless there is impending danger leave the victim where he or she is, then begin artificial respiration. Once you begin artificial respiration, you must continue without losing rhythm.

- (1) Make contact with the victim cautiously, there is a risk that you may get electrocuted.
- (2) Switch off the machinery and then move the victim away slowly if you must.
- (3) Inform someone immediately (a hospital or doctor, dial emergency numbers, etc.).
- (4) Lay the victim on his or her back and loosen any constrictive clothing (a tie, or belt).
- (5)
 - (a) Check the victim's pulse.
 - (b) Check for a heartbeat by pressing your ear against the victim's chest.
 - (c) Check if the victim is breathing by putting the back of your hand or face near the victim's face.
 - (d) Check the pupils of the eyes.
- (6) Open the victim's mouth and remove any artificial teeth, cigarette or chewing gum. Leave the mouth opened and flatten the tongue with a towel or by putting something into the mouth to prevent the victim's tongue from obstructing the throat. (If he or she is clenching the teeth and it is difficult to open the mouth, use a spoon or the like to pry open the mouth.)
- (7) Continually wipe the mouth to prevent the accumulation of saliva.

☆ If the victim has a pulse but is not breathing

("Mouth to mouth" resuscitation) Figure 1

- (1) Place the victim's head facing backward (place something under the neck like a pillow).
- (2) Point the chin upward to widen the trachea.
- (3) Pinch the victim's nose, take a deep breath, then put your mouth over the victim's mouth and exhale completely, making sure that your mouth completely covers the victim's mouth. Then remove your mouth. Repeat this routine 10 to 15 times per minute (holding the nostrils).
- (4) Pay attention to the victim to notice if he or she starts to breath. If breathing returns, stop resuscitation.
- (5) If it is impossible to open the victim's mouth, put something like a plastic straw or vinyl tube into one of the nostrils then blow air in while covering the mouth and the other nostril.
- (6) Occasionally, when the victim comes back to consciousness, they immediately try to stand up. Prevent this and keep them in a laying position. Give them something warm to drink and be sure that they rest (do not give them any alcohol).

Administering artificial respiration by raising the head.

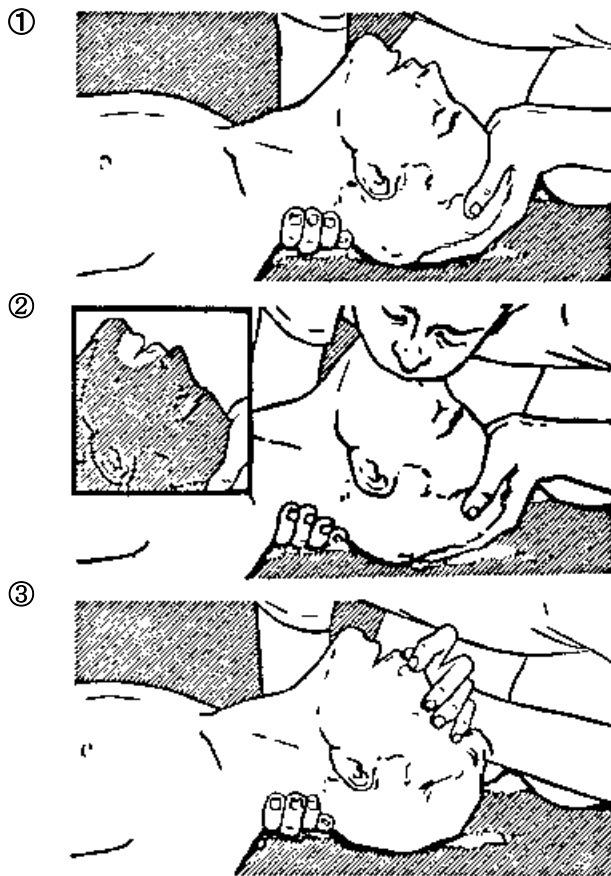

- (1) Raise the back of head, then place one hand on the forehead and place the other hand under the neck. →①
Most victims open their mouth when this is done, making "mouth to mouth" resuscitation easier.

- (2) Cover the victim's mouth by opening your mouth widely, then push your cheek against the victim's nose, →②
or pinch the victim's nose to prevent air from leaking out of it. →③

- (3) Completely exhale into the lungs.
Exhale into the lungs until the chest inflates.
You have to blow as rapidly as possible for the first 10 times.

"Mouth to mouth" artificial respiration
Figure 1

☆ If the victim has no pulse and is not breathing

(Heart massage in combination with artificial respiration.) Figure 2

If the victim has no pulse, his or her pupils are dilated, and if you cannot detect a heartbeat, the heart may have stopped, beginning artificial respiration is critical.

- (1) Put both hands on the diaphragm, with hands on top of each other keeping both arms straight (If your elbows are bent, you cannot push with as much power). Press the diaphragm with your body weight until the chest sinks about 2 cm (about 50 times per minute).
- (2) If administering first aid when alone:
Perform the heart massage about 15 times then blow in twice. Repeat this routine.
If administering first aid with two people:
One person performs the heart massage 5 times, and the other person blows air in once. Repeat this routine (Heart massage and "mouth to mouth" resuscitation used together).
- (3) Constantly check the pupils and the pulse, if the pupils become normal and the pulse steadies, keep them in a laying position and give them something warm to drink, be sure that they rest (do not give them any alcohol). In any case you have to entrust major decision making to a doctor. Having understanding people around is essential to the victim's recovery from the mental shock of electrocution.

①

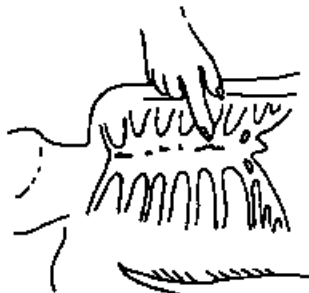

②



③



④

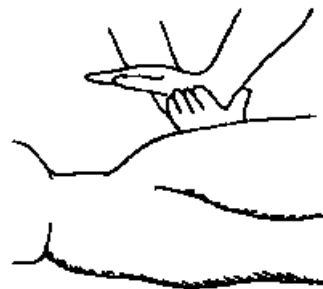

(Heart massage in combination with artificial respiration.) Figure 2

Preface

Thank you for choosing the Model JRC JSS-2150 150W MF/HF radio equipment. This radio equipment can be used as a Global Maritime Distress and Safety System (GMDSS) radio device, compliant with international regulations, that provides emergency communications and standard communications capabilities for small and large ships.

- Please read this instruction manual thoroughly before using the JSS-2150 150W MF/HF radio equipment, and use it in accordance with the instructions contained herein.
- Please keep this manual available for future reference. Please refer to it if any difficulties are encountered when using the equipment.

Before operation

Concerning the symbols

This manual uses the following symbols to explain correct operation and to prevent injury or damage to property.

The symbols and descriptions are as follows. Understand them before proceeding with this manual.



Indicates a warning that, if ignored, may result in serious injury or even death.



Indicates a caution that, if ignored, may result in injury or damage to property.

Examples of symbols



The Δ symbol indicates caution (including DANGER and WARNING). The illustration inside the Δ symbol specifies the content of the caution more accurately. (This example warns of possible electrical shock.)



The \circ symbol indicates that performing an action is prohibited. The illustration inside the \circ symbol specifies the contents of the prohibited operation. (In this example disassembly is prohibited.)



The \bullet symbol indicates operations that must be performed. The illustration inside the \bullet symbol specifies obligatory instructions. (In this example unplugging is the obligatory instruction.)

Concerning the WARNING labels

The WARNING labels are put on the NTD-2150 MF/HF Transceiver, NFC-2150 Antenna tuner, NBD-2150 AC/DC Power supply, and NBB-714/724 Battery charger. Do not take off, destroy, or modify the labels.

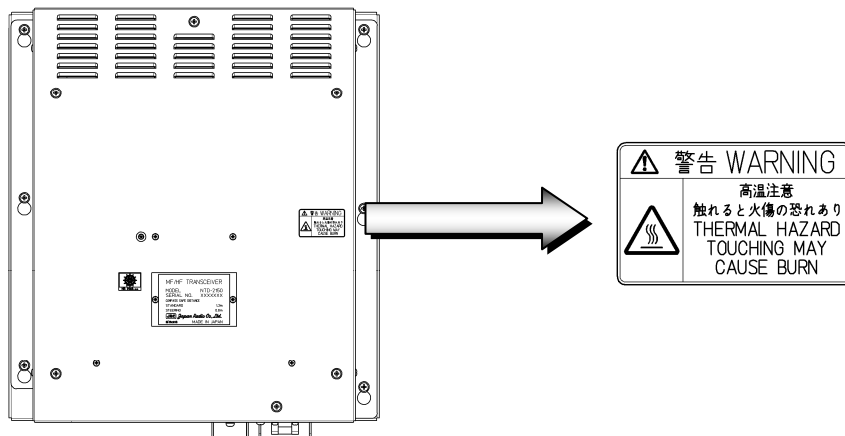

NTD-2150 MF/HF Transceiver

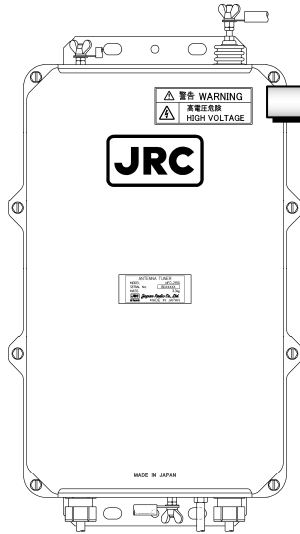

⚠	警告 WARNING
⚡	高電圧危険 HIGH VOLTAGE

NFC-2150 Antenna tuner

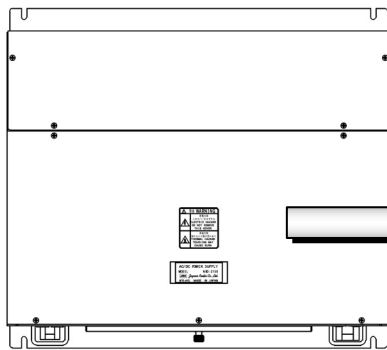

⚠	警告 WARNING
⚡	感電注意 このカバーをはずすな ELECTRIC HAZARD DO NOT REMOVE THIS COVER
🔥	高温注意 触れると火傷の恐れあり THERMAL HAZARD TOUCHING MAY CAUSE BURN

NBD-2150 AC/DC Power supply

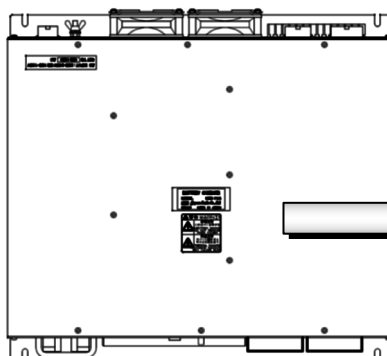

⚠	警告 WARNING
⚡	感電注意 このカバーを外すな ELECTRIC HAZARD DO NOT REMOVE THIS COVER
🔥	高温注意 カバーに触れると やけどの恐れあり THERMAL HAZARD TOUCHING RADIATOR MAY CAUSE BURN

NBB-714/724 Battery charger

Handling precautions

WARNING



Do not open the equipment to inspect or repair internal circuits. Inspection or repairs by anyone other than a specialized technician may result in fire, electrical shock, or malfunction.

If internal inspection or repair is necessary, contact our service center or agents.



Do not disassemble or customize this unit.

Doing so may cause fire, electrical shock, or malfunction.



Do not get this equipment wet or spill any liquids on or near this equipment.

Doing so may cause electrical shock, or equipment malfunction.



Do not touch any of the areas with warning labels.

Doing so may cause electrical shock.



Do not use voltage other than that specified.

Doing so may cause fire, electrical shock, or malfunction.



Do not remove protective covers on the high voltage terminals.

Doing so may cause electrical shock.



Do not insert anything flammable into the equipment.

Doing so may cause fire, electrical shock, or malfunction.



If a distress alert is received, make sure to inform the ship's captain or officer in charge.

Doing so may save the lives of the crews and passengers on the ship in distress.



This equipment is used for both distress communication and routine communication. Contact JRC or our agent if any problem is observed in this unit during routine operation or inspection.

CAUTION



Do not use this equipment anywhere other than specified.
Doing so may cause failure or malfunction.



Do not turn the trimmer resistors or the trimmer capacitors on the PCB unit.
Doing so may cause failure or malfunction.



Do not install the equipment in a place near water or in one with excessive humidity, steam, dust, or soot.
Doing so may cause fire, electrical shock, or malfunction.



Do not test the distress alert.
Doing so may inconvenience local shipping and rescue centers.



Do not turn off the equipment when at sea because the SOLAS Convention requires keeping watch on distress and safety frequencies at all times. Always listen to 2187.5 kHz, and 8414.5 kHz, and one or more of the following frequencies; 4207.5 kHz, 6312.0 kHz, 12577.0 kHz, or 16804.5 kHz. In class B mode, it is necessary to keep watch only on 2187.5 kHz.



When completely turning off the power to the equipment, turn off the breaker on the transceiver



To operate DSC functions of the equipment, the ID numbers assigned to the ship must be registered in advance. If registration is necessary, contact our service center or agents.



To install this equipment, contact our service center or agents.
Special knowledge on selecting the place where the antenna is to be mounted and setting the ID number (MMSI) assigned to the ship is required in addition to installing the equipment.



When sending a distress alert, follow the instructions of the ship's captain or officer in charge.



If a false distress alert is transmitted accidentally, select the Cancel menu and transmit the distress cancel referring the guidance displayed on the controller. And then report the false distress alert to a nearby RCC (Rescue Coordination Center/ in Japan, inform the nearest Japan Coast Guard.)

Information to be reported:

Ship's name, type, nationality, and ID number, the date/time, location and reason why the false distress alert was transmitted. Also the unit model name and manufacture number/date, if possible.



To turn off an alarm or clear a display such as a received DSC message, do not press the **DISTRESS** key. Doing so may cause a false distress alert.
(Press the **CANCEL** key to turn off the alarm.)



When sending a drobose call, do NOT press the **DISTRESS** key. Doing so may cause a false distress alert.
(Drobosc calls can be sent via the [Call] button displayed on the screen.)



A distress acknowledgement or a distress relay call can be transmitted using the option on an active procedure screen, but when sending such a call, follow the instructions of the ship's captain or officer in charge.

CAUTION



DSC messages with incorrect format or data may not be received, but it is not a malfunction. Also if the data terminal is not connected, the equipment does not receive DSC calls requesting ARQ/FEC communication, regardless of either the category of routine, safety, urgency or distress.



Received distress message logs are automatically deleted after 48 hours to avoid accidental resending or other misoperation. Accordingly, if such messages cannot be read, it is not a malfunction.



The received distress message logs are cleared when turning off the power by such as the breaker on the transceiver. Due to the SOLAS Convention (keeping watch on distress and safety frequencies at all times), do not turn off the equipment when at sea.



The time in the 7.1 Date & time menu means the present time, and is different from the time in the 7.2 POS/TIME menu that means the time when the position information is valid.



The time in the 7.2 POS/TIME menu means the time when the position information is valid, and is different from the present time mentioned in the 7.1 Date & time menu.



When replacing fuses, always use fuses of the same type.



The batteries, except for sealed lead-acid batteries that require no equalization, should be carried out the equalizing charge at least every six months.



The thermal head of the NKG-91 printer may be very hot after printing. Do not touch the thermal head of the printer. Make sure the thermal head is cool before replacing the paper or cleaning the thermal head.



The paper used in the NKG-91 printer is heat sensitive. Take the following precautions when using this paper.

- Store the paper away from heat, humidity, or heat sources.
- Do not rub the paper with any hard objects.
- Do not place the paper near organic solvents.
- Do not allow the paper to come in contact with polyvinyl chloride film, erasers, or adhesive tape for long periods of time.
- Keep the paper away from freshly copied diazo type or wet process copy paper.



The print head of the NKG-800 printer may be very hot after printing. Do not touch the print head of the printer. Make sure the print head is cool before replacing the paper or cleaning the print head.



Do not use the NKG-800 printer if there is no ink ribbon cartridge or paper. Do not twist the ink ribbon when installing the ink ribbon cartridge.



Before opening and closing the cover of the NKG-800 printer, turn off the printer. Wait more than 2 seconds after turning the printer off before turning it back on again so it can initialize correctly.



Be sure to unmount the USB flash memory before removing it from the NDZ-227 Data terminal at work.

CAUTION



The print head of the NKG-900 printer may be very hot after printing. Do not touch the print head of the printer. Make sure the print head is cool before replacing the paper or cleaning the print head.



Do not use the NKG-900 printer if there is no ink ribbon cartridge or paper. Do not twist the ink ribbon when installing the ink ribbon cartridge.



To avoid malfunction, do not use the paper feed knob during power on.



Before opening and closing the cover of the NKG-900 printer, turn off the printer. Wait more than 2 seconds after turning the printer off before turning it back on again so it can initialize correctly.

DISTRESS ALERTS

Sending a Distress Alert

⚠ CAUTION



When sending a distress alert, follow the instructions of the ship's captain or officer in charge.

1. Open the **DISTRESS** key cover on the NCM-2150 MF/HF CONTROLLER.



2. Press and hold the **DISTRESS** key for 4 seconds to send the distress alert. When the countdown is finished the screen below on the right is displayed, and after antenna tuning the distress alerts are transmitted.

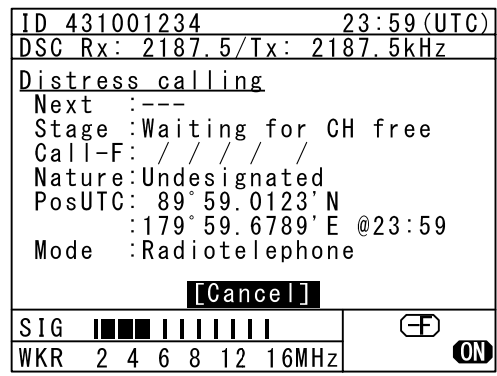
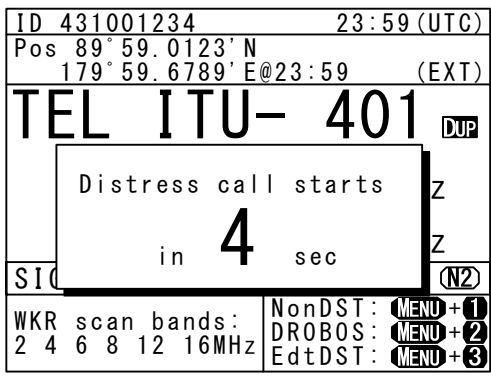

3. After sending the distress alert, wait for an acknowledgement.

The radiotelephone can be used to communicate even while waiting for an acknowledgement on the screen below left. When an acknowledgement is received, press the **CANCEL** key or ENT to cancel the alarm on the below right screen, and communicate with the station. Unless an acknowledgement is received or the distress alert is cancelled manually, the equipment repeats the distress alert every 3.5 to 4.5 minutes.

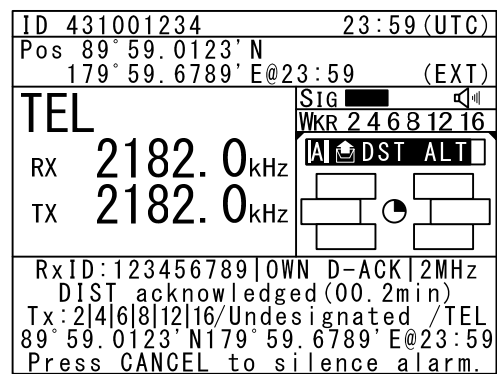
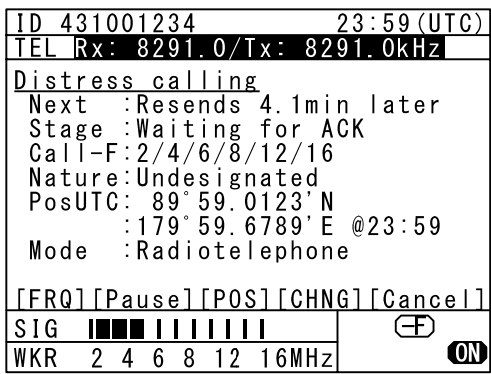

4 After receiving acknowledgement, use the radiotelephone to request rescue.

First, the responding station calls by radiotelephone. Communicate the following information to that station.

- Say "MAYDAY".
- Say "This is (name of your ship)".
- Tell the station the ship's Maritime Mobile Service Identity (MMSI) number, call sign, ship's position, nature of distress, and rescue requests.

Note

If time permits, enter the nature of the distress or the mode (Radiotelephone or FEC) as follows, just before sending the distress alert. (For more details, see 4.5.5 Distress alerts.)

- 1) **Open menu 3. Editing a distress msg.**
- 2) **Press ENT on the screen at right and select the nature of the distress.**
- 3) **Press ENT to confirm the selection.**
The nature of the distress is set. If the position and time (UTC) are not displayed automatically for any reason, input them manually at this time.
- 4) **Press and hold the **DISTRESS** key for 4 seconds to send the distress alert.**
The rest of the procedure is the same as described above.

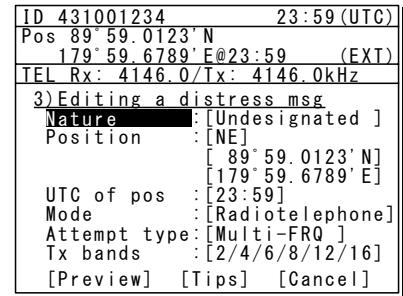

Terminating a Distress Alert

⚠ CAUTION



If a false distress alert is transmitted accidentally, select the Cancel menu and transmit the distress cancel referring the guidance displayed on the controller. And then report the false distress alert to a nearby RCC (Rescue Coordination Center/ in Japan, inform the nearest Japan Coast Guard.)

Information to be reported:

Ship's name, type, nationality, and ID number, the date/time, location and reason why the false distress alert was transmitted. Also the unit model name and manufacture number/date, if possible.

Select the Cancel menu and press ENT on the NCM-2150 MF/HF CONTROLLER.

The screen shown below is displayed. Then select Continue with the jog dial and press ENT to start the distress cancel procedure referring the guidance displayed on the controller.

Note) For more details, see the description in the 4.5.5.1 Quick distress alerts.

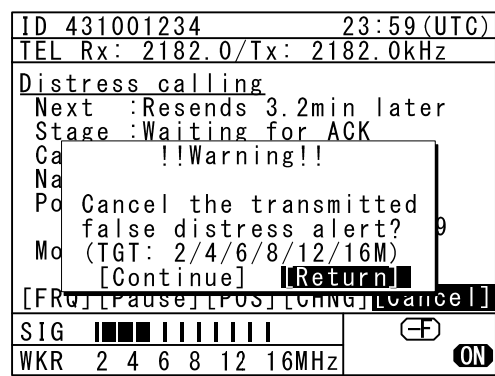

Receiving a Distress Alert

⚠️ WARNING



If a distress alert is received, make sure to inform the ship's captain or officer in charge. Doing so may save the lives of the crews and passengers on the ship in distress.

1. When a distress alert is received, the information such as the ID number of the ship in distress and the stage of the distress event are displayed.
If the equipment is not used, i.e. there is no active procedure at that time, a distress and safety frequency is set and the ALM lamp starts blinking, and an alarm gradually grows louder.

ID 431001234		23:59 (UTC)	
Pos 89° 59.0123' N		179° 59.6789' E@23:59 (EXT)	
TEL	SIG []	WKR 2 4 6 8 12 16	
RX 2182.0 kHz	[A] [D] DST ALT		
TX 2182.0 kHz	[]	[]	[]
RxID:123456789 DISTRESS ALT Waiting to send ACK(00.2min) Single-FRQ: 2187.5kHz TEL :Rx 2182.0/Tx 2182.0KHz Press CANCEL to silence alarm.			

2. Press the **CANCEL** key to stop the alarm. If the popup screen is shown, select "Accept" and press ENT.
After the specified communicate mode and the distress frequency are set, keep watch under such a condition. Keep watch for five minutes or more, and executes the report to the coast station etc. as appropriate

ID 431001234		23:59 (UTC)	
Pos 89° 59.0123' N		179° 59.6789' E@23:59 (EXT)	
TEL	SIG []	WKR 2 4 6 8 12 16	
RX	SAME DST ON ANOTHER FRQ		
TX	From :123456789		
	Work-F : 8291.0kHz		
	EQP will tune to the		
	above FRQ within 10s.		
	[Accept]	[Ignore]	[]
Single-FRQ: 2187.5kHz			
TEL :Rx 2182.0/Tx 2182.0kHz			
[ACK] [RLY] [INF] [FRQ] [HLD] [END]			



ID 431001234		23:59 (UTC)	
Pos 89° 59.0123' N		179° 59.6789' E@23:59 (EXT)	
TEL	SIG []	WKR 2 4 6 8 12 16	
RX 8291.0 kHz	[A] [D] DST ALT		
TX 8291.0 kHz	[]	[]	[]
RxID:123456789 DISTRESS ALT Waiting to send ACK(00.6min) Multi-FRQ:2/ / /8/ / TEL :Rx 8291.0/Tx 8291.0KHz [ACK] [RLY] [INF] [FRQ] [HLD] [END]			

3. To acknowledge to the distress alert after coordination with the coast station, from the above right screen, press **FUNC** key to move the active screen to the message control area. Then select **ACK** with jog dial and press **ENT** to send the acknowledgement.

After acknowledging the distress alert, communicate with the ship in distress as follows;

- Say "MAYDAY".
- Repeat the identity (MMSI) of the ship in distress 3 times
- Say, "This is".
- Repeat the identity (MMSI) of your ship 3 times
- Say "RECEIVED MAYDAY".

Equipment exterior

- JSS-2150 150W MF/HF Radio Equipment



NTD-2150 150W MF/HF Transceiver

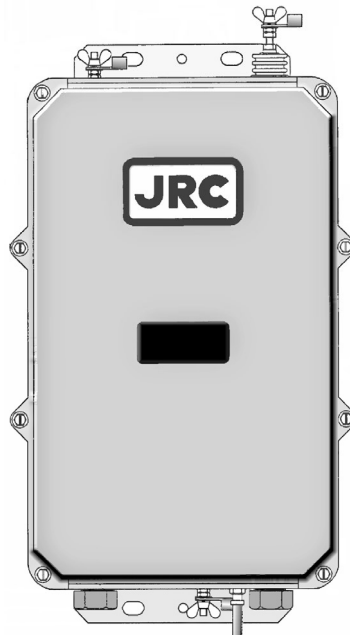

NFC-2150 Antenna tuner



NCM-2150 MF/HF Controller/NQW-261 Handset

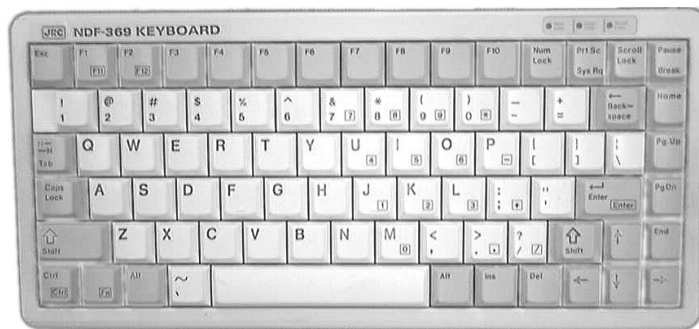

NDZ-227 Data terminal / NDF-369 Keyboard



NKG-800 Printer

- NKG-900 Printer



- DPU-414 Printer



- NKG-91 Printer

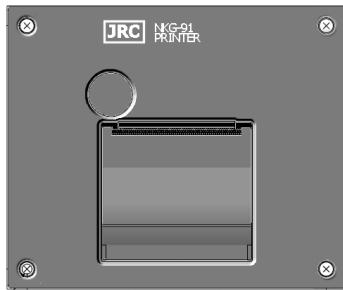

- NBD-2150 AC/DC Power supply

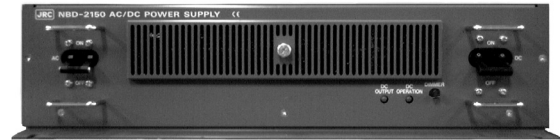

- NBB-714 Battery charger (10A)



- NBB-724 Battery charger

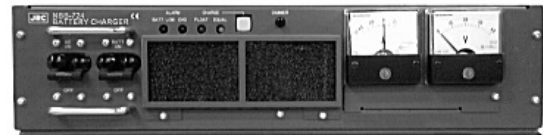

- NCH-321A Distress Message Controller (DMC)

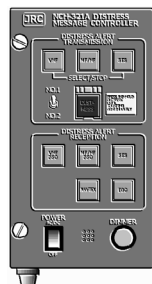

Contents

Preface	v
Before operation	vi
Handling precautions	viii
DISTRESS ALERTS	xii
Equipment exterior	xv
Glossary of terms	xxii
1. EQUIPMENT OVERVIEW	1-1
1.1 Functions	1-1
1.2 Features	1-1
1.3 Basic configuration	1-2
1.3.1 DSC model	1-2
1.3.1.1 Standard components	1-2
1.3.1.2 Options	1-2
1.3.2 DSC/NBDP model	1-3
1.3.2.1 Standard components	1-3
1.3.2.2 Options	1-3
1.3.3 System configuration	1-4
1.4 External dimensions	1-5
1.5 Block diagram	1-13
1.5.1 DSC model	1-13
1.5.2 DSC/NBDP model	1-14
2. NAMES AND FUNCTIONS	2-1
2.1 Controller (NCM-2150)	2-1
2.2 Controller's display	2-3
2.2.1 Status display	2-3
2.2.2 Operating display	2-4
2.2.3 Function screen and key operations	2-6
2.2.4 Menu screen	2-7
2.3 Data terminal (NDZ-227)	2-8
2.4 Display of data terminal	2-9
2.4.1 Regular screen	2-9
2.4.2 Telex communication screen	2-10
2.4.3 Message file edit screen	2-11
3. INSTALLATION	3-1

4. OPERATION	4-1
4.1 Operation overview	4-1
4.1.1 Operation of the controller	4-1
4.1.2 Operation of the data terminal	4-4
4.2 Basic communications procedure	4-6
4.2.1 Turning on the power	4-6
4.2.2 Turning off the power/ Putting into sleep mode	4-7
4.2.3 Communicating in radiotelephone mode	4-8
4.2.4 Communicating in CW mode	4-10
4.2.5 Receiving AM broadcasts	4-12
4.2.6 Communicating in telex mode (TLX)	4-13
4.2.6.1 ARQ mode operation	4-13
4.2.6.2 CFEC mode operation	4-16
4.2.6.3 SFEC mode operation	4-20
4.2.6.4 Editing telex messages	4-22
4.3 Setting the radio	4-25
4.3.1 Setting the communication frequencies	4-25
4.3.2 Setting the communication channels	4-26
4.3.3 Setting the automatic gain control (AGC)	4-30
4.3.4 Setting the noise reduction (NR)	4-30
4.3.5 Setting the attenuation (ATT)	4-31
4.3.6 Setting the clarifier	4-31
4.3.7 Setting the squelch level	4-32
4.3.8 Setting the CW bandwidth	4-32
4.3.9 Scanning the Rx frequencies	4-33
4.3.10 Reducing the Tx power	4-35
4.3.11 Setting the antenna tuning power	4-35
4.3.12 Setting the Auto Tune Start (ATS) function	4-35
4.4 Basic DSC operations	4-36
4.4.1 Routine calls to an individual station	4-36
4.4.2 Receiving routine individual calls	4-38
4.4.3 Routine group calls	4-40
4.4.4 Receiving routine group calls	4-40
4.5 Emergency calls (DSC distress/urgency/safety calls)	4-41
4.5.1 Safety or urgency calls to an individual station	4-41
4.5.1.1 Special safety individual calls	4-41
4.5.2 Receiving safety or urgency individual calls	4-43
4.5.2.1 Receiving special safety individual calls	4-43
4.5.3 Safety or urgency area calls	4-44
4.5.4 Receiving safety or urgency area calls	4-45
4.5.5 Distress alerts	4-46
4.5.5.1 Quick distress alerts	4-46
4.5.5.2 Distress alerts from the menu	4-49
4.5.5.3 Receiving distress alerts	4-52
4.5.6 Distress relay calls on behalf of someone else (DROBOSE)	4-53

4.6	DSC call log	4-55
4.6.1	Received distress messages	4-55
4.6.2	Received other messages	4-56
4.6.3	Transmitted messages	4-56
4.7	Display of telex communication logs	4-57
4.8	USB memory operation	4-58
4.9	Popup screens	4-59
5.	SETTINGS & REGISTRATIONS	5-1
5.1	Date and time settings	5-1
5.2	Own ship position and time settings	5-3
5.3	Controller settings	5-4
5.3.1	LCD adjustment	5-4
5.3.2	Sound settings	5-4
5.3.3	User key assignments	5-5
5.3.4	Selecting Tx meters	5-6
5.3.5	Transferring user channel data to another controller	5-7
5.3.6	Setting the inactivity timer (for menu shutdown)	5-8
5.3.7	Setting the reference value for the channel auto search	5-8
5.4	Registering user channels	5-9
5.5	Advanced settings for DSC/WKR	5-11
5.5.1	Automatic acknowledgement	5-11
5.5.2	Setting DSC watch frequency	5-11
5.5.3	Setting receiving alarms	5-12
5.5.4	Using medical/neutral settings for urgency calls	5-12
5.5.5	Registering the ship's group ID	5-12
5.5.6	Setting the inactivity timer (for procedures on hold)	5-13
5.5.7	Registering the DSC call list	5-13
5.6	Setting connections for options	5-14
5.7	Setting of data terminal	5-15
5.7.1	LCD adjustment	5-15
5.7.2	Registering station list	5-17
5.8	Setting telex mode	5-19
6.	MAINTENANCE & INSPECTION	6-1
6.1	General maintenance & inspection	6-1
6.2	Self diagnosis inspection	6-2
6.3	System alarm indication	6-5
6.3.1	Alarm list	6-6
6.3.2	Viewing the alarm history	6-8
6.4	Software version	6-9
6.5	Troubleshooting	6-10
6.5.1	Procedures for locating malfunctions	6-10
6.5.2	Guide to locating faults	6-11
6.5.3	Consumables	6-12
6.5.4	Repair units/parts	6-12
6.5.5	Regular replacement parts	6-13

7. AFTER-SALES SERVICE	7-1
8. DISPOSAL	8-1
9. SPECIFICATIONS	9-1
9.1 JSS-2150 150W MF/HF Radio Equipment	9-1
9.2 Options	9-5
9.3 Peripheral interfaces	9-7
10. OPTIONS OPERATION	10-1
10.1 AC/DC power supply (NBD-2150)	10-1
10.2 Battery charger (NBB-714)	10-2
10.3 Battery charger (NBB-724)	10-4
10.4 Printer (NKG-91)	10-6
10.5 Printer (NKG-800)	10-7
10.6 Printer (NKG-900)	10-10
10.7 Operations using a SELCALL unit	10-14
11. Appendix	11-1
11.1 Frequencies for distress and safety calls	11-1
11.2 National DSC frequencies for routine calls	11-2
11.3 International DSC frequencies for routine calls	11-2
11.4 ITU channel list (TEL/CW/TLX)	11-3
11.5 Guide to MF/HF operation	11-23

Declaration on toxic & hazardous substances or elements
Marking with market circulation mark

Glossary of terms

This section defines general and DSC terms related to this equipment.

● General terms

AMVER

Automated Mutual-assistance Vessel Rescue System

System that informs another ship of position of distress ship operated in the United States.

ARQ

Automatic Repeat reQuest

When communicating interactive in the telex mode, this ARQ is used.

CFEC

Collective Forward Error Correction

When broadcasting in the telex mode, this CFEC is used.

DSC

Digital Selective Calling device

Used in routine calls, safety and urgency calls, and distress alerts for rescue requests.

GMDSS

Global Maritime Distress and Safety System.

GPS

Global Positioning system

IMO

International Maritime Organization

ITU

International Telecommunication Union

Establishes conventions and regulations for all electrical wired and radio, land, sea, air, and space communications. It contains internal organizations such as ITU-R and ITU-T.

ITU-R

The International Telecommunications Union (ITU) radio communications department.

JASREP

Japanese Ship Reporting System

Ship position reporting system operated in Japan.

LT

Local time

MF/HF

Medium frequencies and high frequencies (300 kHz to 30 MHz)

MMSI

Maritime Mobile Service Identity

The 9-digit Maritime Mobile Service Identity number assigned to each ship and coast station.

NBDP

Narrow Band Direct Printing

It is a generic name of the device used to communicate in the telex mode.

NMEA

Maritime equipment transmission standard established by the National Marine Electronics Association.

PTT

Push to talk

RCC

Rescue Co-ordinate Center

RMS

Remote Maintenance System

Transmits ship equipment information temporarily stored in the VDR via Inmarsat to land, for use in maintenance and management of radio equipment.

RR

Radio Regulations

International regulations for radio transmission established by the treaty of the ITU.

SELCAL Number(Selective Calling Number)

Selective Calling Number by NBDP.

It is the numbers of four digits (coast station) or five digits (Ship station) used when the other party is specified in the telex mode.

SFEC**Selective Forward Error Correction**

When broadcasting to a specific group in the telex mode, this SFEC is used.

SOLAS Convention

International Convention for Safety of Life at Sea

The international convention applies to all ships engaged on international voyages. A safety certificate is issued if the conditions of this convention are satisfied.

SQL

Squelch

A function that acts to suppress the audio output of a receiver in the absence of a radio signal of sufficient strength.

UTC

Universal Time Coordinated

VOL (Volume)

Speaker volume

WRC

World Radiocommunication Conference

WKR

Watch Keeping Receiver

The WKR is the receiver dedicated to monitoring the distress and safety frequencies.

● DSC terms

Address

General term for Maritime Mobile Service Identity number (MMSI).

This equipment uses To/From to distinguish between the sender and receiver. It also means the Self-ID (own ship MMSI) and Dist-ID (MMSI of a ship in distress).

Category/ CAT

Message code indicating priority of the call.

Priority levels are listed below.

- Routine... General calls for routine work
- Safety... Calls for safety communications
- Urgency... Calls for urgent communications
- Distress... Calls for distress communications

DROBOSE

Distress relay call (to individual or to area) on behalf of someone else who is in distress.

EOS (End Of Sequence)

Termination code appended to call messages.

Other codes are listed below.

- ACK RQ... Acknowledgement request
- ACK BQ... Acknowledgement responding to the ACK RQ

ECC (Error Check Character)

Error check code appended to the end of call messages.

This is not normally displayed, but if an error occurs on a message, an ECC error is displayed.

Mode

Message code indicating communication mode after a DSC call.

This equipment is fixed to radiotelephone.

Radiotelephone (TEL) or ARQ and FEC (TLX) can be used.

Nature of Distress

Message code indicating the type of distress when a distress alert is issued.

Codes are listed below.

- | | |
|--------------------|------------------------|
| • Fire... | Fire, explosion |
| • Flooding... | Flooding |
| • Collision... | Collision |
| • Grounding... | Grounding |
| • Listing... | Risk of ship capsizing |
| • Sinking... | Sinking |
| • Disabled... | Ship inoperable/adrift |
| • Undesignated... | Undesignated distress |
| • Abandoning... | Abandoning ship |
| • Piracy attack... | Piracy/robbery attack |
| • Man overboard... | Man overboard |

Polling

Polling is a feature for routine calling.

It is used, for example, to confirm whether a ship is within radio range when a coast station requests navigational information of the ship.

Reason

Message code indicating reason for negative acknowledgement response.

Codes are listed below.

- No reason... No reason
- Congestion... Maritime information exchange center congested
- Busy... Busy
- Queue... Queued
- Barred... Station barred
- No operator... No operator
- Temp no oper... Temporarily no operator
- EQP disabled... Equipment disabled
- Unable FRQ... Indicated frequency cannot be used
- Unable mode... Indicated mode cannot be used

Rx FRQ

Received frequency of the call

Subject/ Sub

Message code clarifying communication contents when sending an urgency call to all ships.

When sailing in dangerous waters, such as in areas of political instability, these call messages are used with the following information.

- Neutral ship: In accordance with ITU resolution 18 (Mob-83), inform all ships that own ship is of neutral nationality.
- Medical TRANSP: Inform all ships that own ship is performing medical transportation, and is protected under the 1949 Geneva Convention.

Topic

Message codes in an acknowledged message
After sending an individual call, "Unable to comply" is received when the responding station cannot comply.

Type

Message code indicating the type of the call. Codes are listed below.

- Individual call... Individual call message
- Individual ACK... Acknowledgement of individual call message
- Individual NACK... Negative acknowledgement of individual call message
- Group call... Group call message
- GEO area call... Area call message
- All ships call... Call to all ships
- Distress... Distress alert message
- Distress ACK... Acknowledgement of distress alert message
- Distress relay... Distress relay message
- Distress relay ACK... Acknowledgement of distress relay message
- Distress relay GEO... Area call of distress relay message

Intent

Message code indicating specific content. Indicates the type of the call for a specific purpose, not for radiotelephone communication.

- Polling... Polling
- Position RQ... Ship position request
- Ship position... Ship position notification
- Test... Safety test call

Work FRQ/ WFRQ

Message code indicating communication frequency after a DSC call.

1. EQUIPMENT OVERVIEW

1.1 Functions

This equipment includes MF/HF transceiver, Class-A DSC and DSC watch keeping receiver required as the Global Maritime Distress and Safety System (GMDSS). It is designed as a separated transceiver and small, lightweight controller(s) for easy installation not only in SOLAS Convention ships such as international passenger ships and freight ships of 300 tons or more, but also non-conventional ships of less than 300 tons.

As for the main communication function, in addition to the communications of radiotelephone with the handset and the Morse communication with the CW keyer, calling by digital selective calling (DSC) for a general or distress communication are possible. Furthermore, if the data terminal is connected to the controller, the telex communication in the ARQ or FEC mode using the NBDP is available.

1.2 Features

- Compliant with the ITU Radio Regulations (RR), the IMO performance standards, and the ITU-R recommendations.
- Contains all channels specified in the ITU Radio Regulations (RR).
- Separately designed transceiver and controller enable easy installation in limited or difficult spaces.
- A semi-transmissive LCD with a wide viewing angle is easily viewable even in direct light or when backlit and allows it to be installed in a variety of positions.
- The backlights of the LCD and operation keys are fully adjustable, preventing interference with night watch keeping.
- When in distress, the DSC can send a distress message with the expanded position data accurate up to 1/10000 of a minute for both latitude and longitude to make search and rescue operations by the RCC easier.
- High-quality stable operation is possible by using DSP technology on a transceiver with a DSC/WKR modem.
- The DSC operates in Class A mode suitable for all areas, and in Class B mode limited to ships navigating in A1 and A2 areas.
- An advanced digital audio amplifier with a built-in loud speaker provides a maximum of 5 W of clear audio.
- The maintenance and the check can be easily done at daily or the regular services, because a special function key was prepared for the DSC safety test calling and the self-diagnosis.
- It is possible to operate on the screen with the character color and the background color corresponding to the favor because the data terminal for the telex communication by NBDP adopted the color liquid crystal display of the wide viewing angle in high brightness.
- Besides printers and GPS, other peripherals such as the remote maintenance system (RMS) can be connected to the equipment.

1.3 Basic configuration

1.3.1 DSC model

1.3.1.1 Standard components

No.	Description	Model	Qty	Notes
1	MF/HF transceiver	NTD-2150	1	
2	MF/HF controller	NCM-2150	1	
2-1	Controller cable	7ZCJD0343	1	5m
2-2	Handset	NQW-261	1	Includes the cradle
3	Antenna tuner	NFC-2150	1	
4	Instruction manual	7ZPJD0569	1	This manual

1.3.1.2 Options

No.	Description	Model	Notes
1	AC/DC power supply	NBD-2150	
2	Battery charger	NBB-724	22A
3	Battery charger	NBB-714	10A *For maintenance-free sealed battery only
4	Joint box	JQD-69C	For both RX and WKR
5	Junction box	NQD-2253	
6	Coaxial connector	M-P-7, M-A-JJ	For RG-12/UY and RG-10/UY
7	MF/HF controller	NCM-2150	One additional controller available.
7-1	Controller cable	7ZCJD0343	5m
7-2	Handset	NQW-261	Waterproof type (IP66 equivalent)
7-3	Flush mounting bracket	MPBC42957	
7-4	Mounting bracket	MPBX44354	
7-5	Connection box	NQD-2250	For extension and expansion of the controller
8	Printer	NKG-800/900	
8-1	Printer connection cable	6ZCSC00407 7ZCSC0205A/0322B	Desktop type
8-2	Printer power cable	6JNKD00100B	
8-3	Printer paper (100m) Printer paper (105m)	5ZPCM00020 5ZPAL00002	
8-4	Ink ribbon (SP-16051)	5ZZCM00003	For NKG-800
8-5	Ink ribbon (7Q1VP80S)	7ZZJD0105	For NKG-900
9	Printer	NKG-91	
9-1	Printer connection cable	7ZCJD0254A	Wall mount or flush mount type
9-2	Printer paper	7ZPJD0384	
9-3	Wall mounting bracket	MPBP31446	
10	Printer	DPU-414	
10-1	Printer connection cable	7ZCJD0254A	Desktop type
10-2	Printer power cable	7ZCJD0257C	
10-3	Printer paper	6ZCAF00252A	
11	Distress message controller	NCH-321A	

1.3.2 DSC/NBDP model

1.3.2.1 Standard components

No.	Description	Model	Qty	Notes
1	MF/HF transceiver	NTD-2150	1	
2	MF/HF controller	NCM-2150	1	
2-1	Controller cable	7ZCJD0343	1	5m
2-2	Handset	NQW-261	1	Includes the cradle
3	Antenna tuner	NFC-2150	1	
4	Data terminal	NDZ-227	1	NBDP option
4-1	DTE cable	7ZCJD0388	1	
4-2	DTE power cable	7ZCJD0419	1	
4-3	Keyboard	NDF-369	1	
5	Printer	NKG-800/900	1	
5-1	Printer connection cable	7ZCSC0322B	1	
5-2	Printer power cable	6JNKD00100B	1	
6	Instruction manual	7ZPJD0569	1	This manual

1.3.2.2 Options

No.	Description	Model	Notes
1	AC/DC power supply	NBD-2150	
2	Battery charger	NBB-724	22A
3	Battery charger	NBB-714	10A *For maintenance-free sealed battery only
4	Joint box	JQD-69C	For both RX and WKR
5	Junction box	NQD-2253	
6	Coaxial connector	M-P-7, M-A-JJ	For RG-12/UY and RG-10/UY
7	MF/HF controller	NCM-2150	One additional controller available.
7-1	Controller cable	7ZCJD0343	5m
7-2	Handset	NQW-261	Waterproof type (IP66 equivalent)
7-3	Flush mounting bracket	MPBC42957	
7-4	Mounting bracket	MPBX44354	
7-5	Connection box	NQD-2250	For extension and expansion of the controller
8	Data terminal	NDZ-227	For expansion of the controller
8-1	DTE cable	7ZCJD0388	
8-2	DTE power cable	7ZCJD0419	
8-3	Keyboard	NDF-369	
8-4	Mounting bracket	MPBP31721	
8-5	USB memory	UDG4-1GAR-JRC	Hagiwara Sys-Com / 1GB
9	Printer	NKG-800/900	Desktop type
9-1	Printer connection cable	6ZCSC00407 7ZCSC0205A/0322B	
9-2	Printer power cable	6JNKD00100B	
9-3	Printer paper (100m)	5ZPCM00020	
	Printer paper (105m)	5ZPAL00002	
9-4	Ink ribbon (SP-16051)	5ZZCM00003	For NKG-800
9-5	Ink ribbon (7Q1VP80S)	7ZZJD0105	For NKG-900
10	Printer	NKG-91	Wall mount or flush mount type
10-1	Printer connection cable	7ZCJD0254A	
10-2	Printer paper	7ZPJD0384	
10-3	Wall mounting bracket	MPBP31446	
11	Printer	DPU-414	Desktop type
11-1	Printer connection cable	7ZCJD0254A	
11-2	Printer power cable	7ZCJD0257C	
11-3	Printer paper	6ZCAF00252A	
12	Distress message controller	NCH-321A	

1.3.3 System configuration

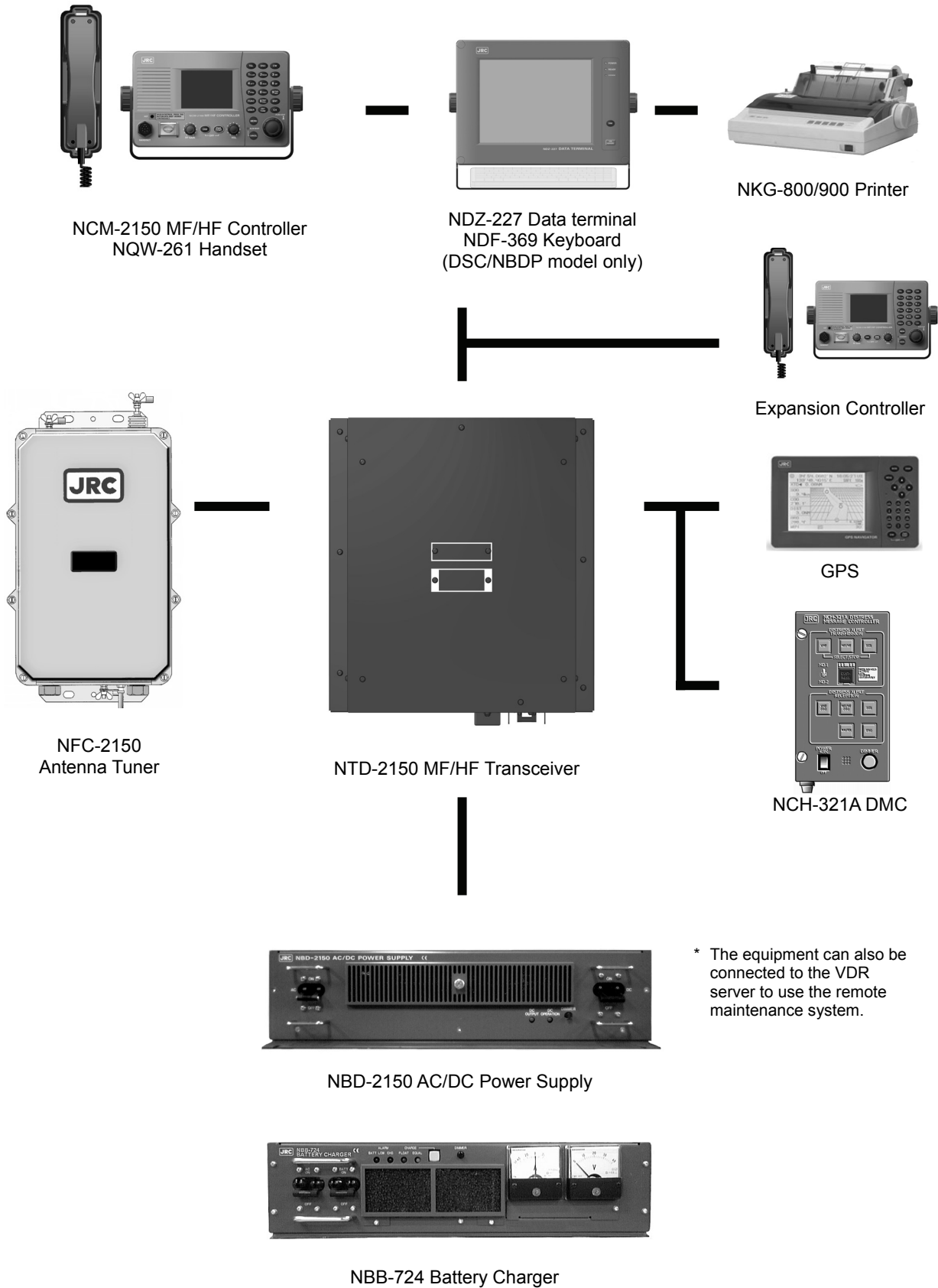

* The equipment can also be connected to the VDR server to use the remote maintenance system.

1.4 External dimensions

Below are the external dimensions of each unit.

(1) MF/HF Transceiver (NTD-2150)

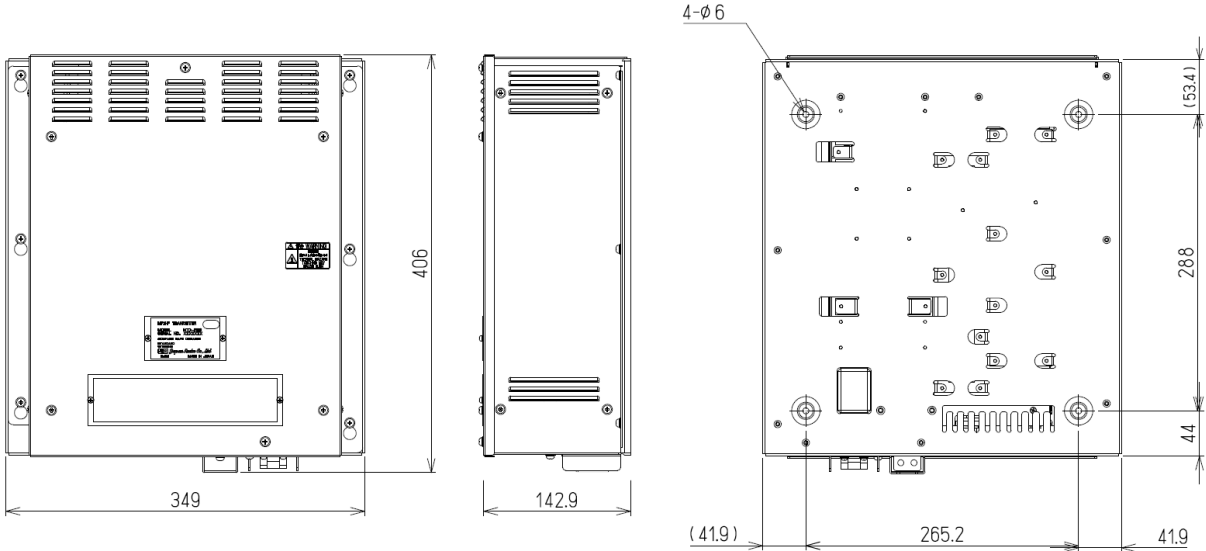

Unit: mm
Weight: Approx. 13 kg

(2) MF/HF Controller (NCM-2150)

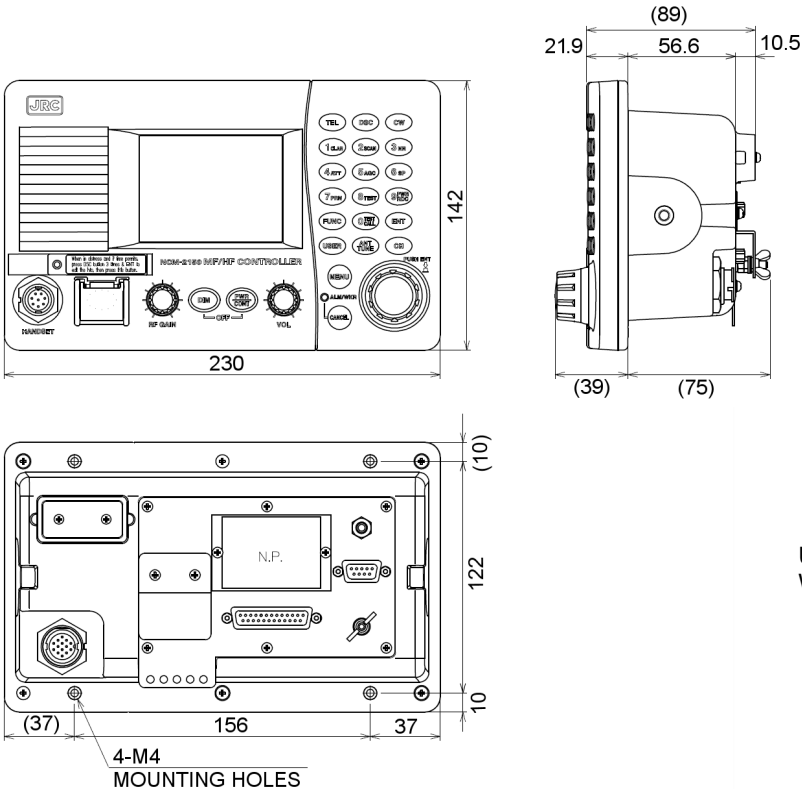

Unit: mm
Weight: Approx. 1.4 kg

Equipment Overview

(3) Handset (NQW-261)

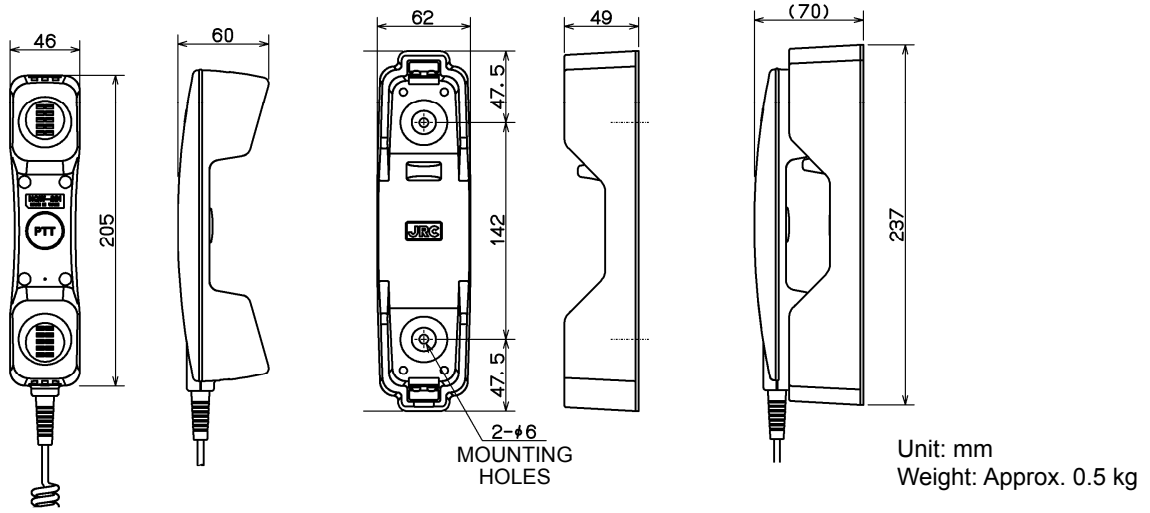

(4) Connection box (NQD-2250)

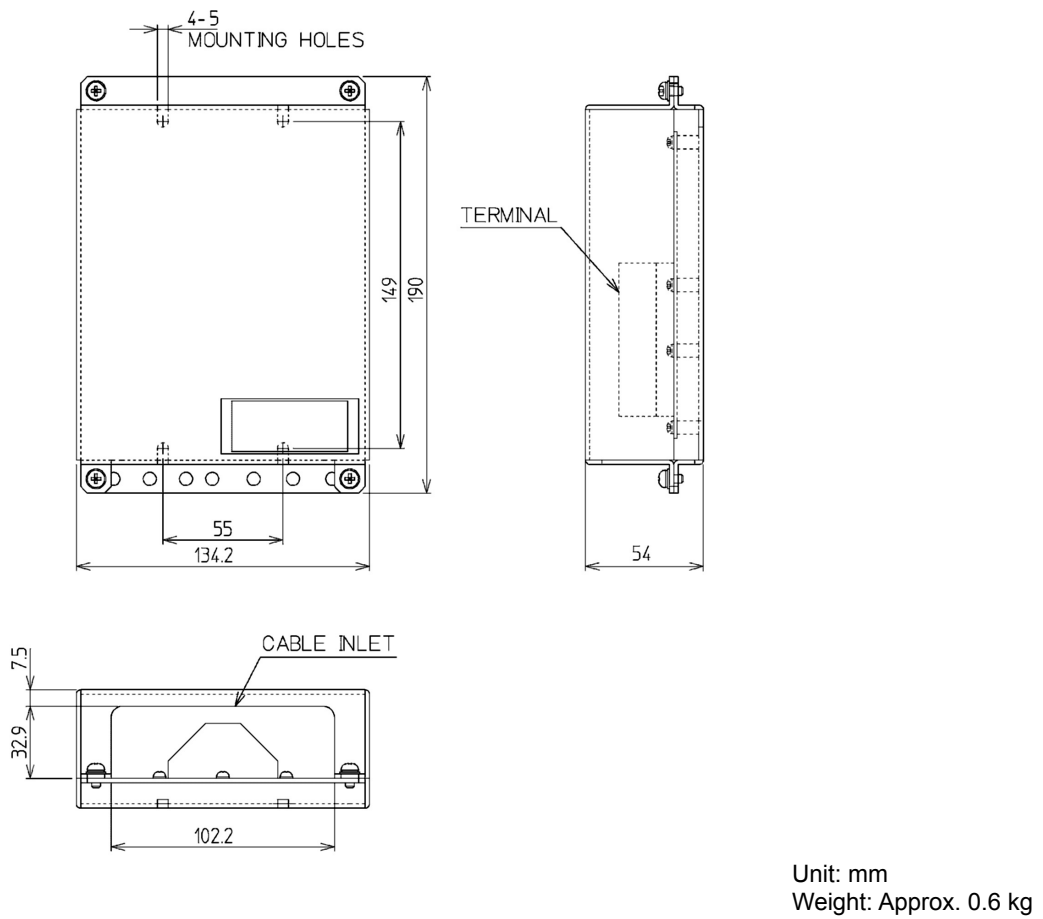

(5) Antenna Tuner (NFC-2150)

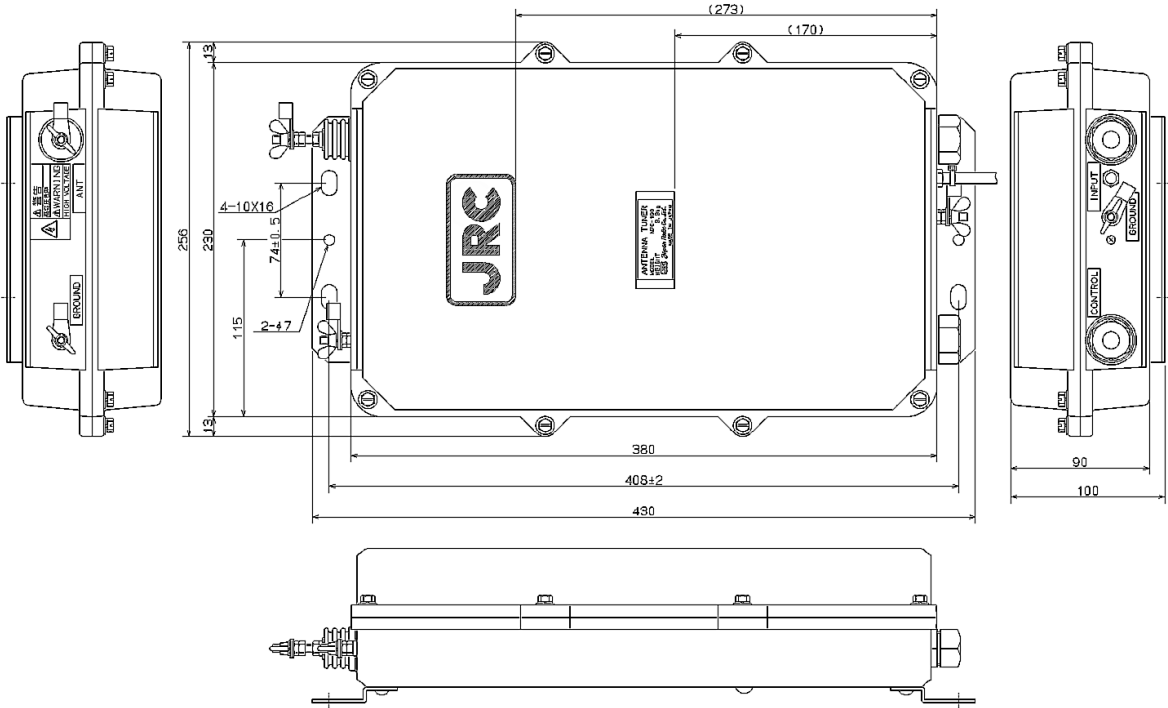

Unit: mm
Weight: Approx. 3.3 kg

(6) Junction Box (NQD-2253)

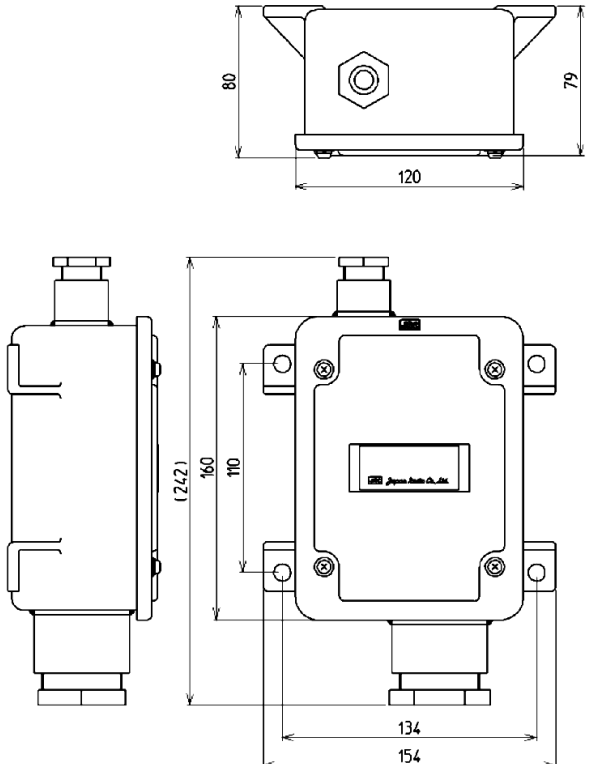

Unit: mm
Weight: Approx. 1.2 kg

Equipment Overview

(7) Data Terminal (NDZ-227)

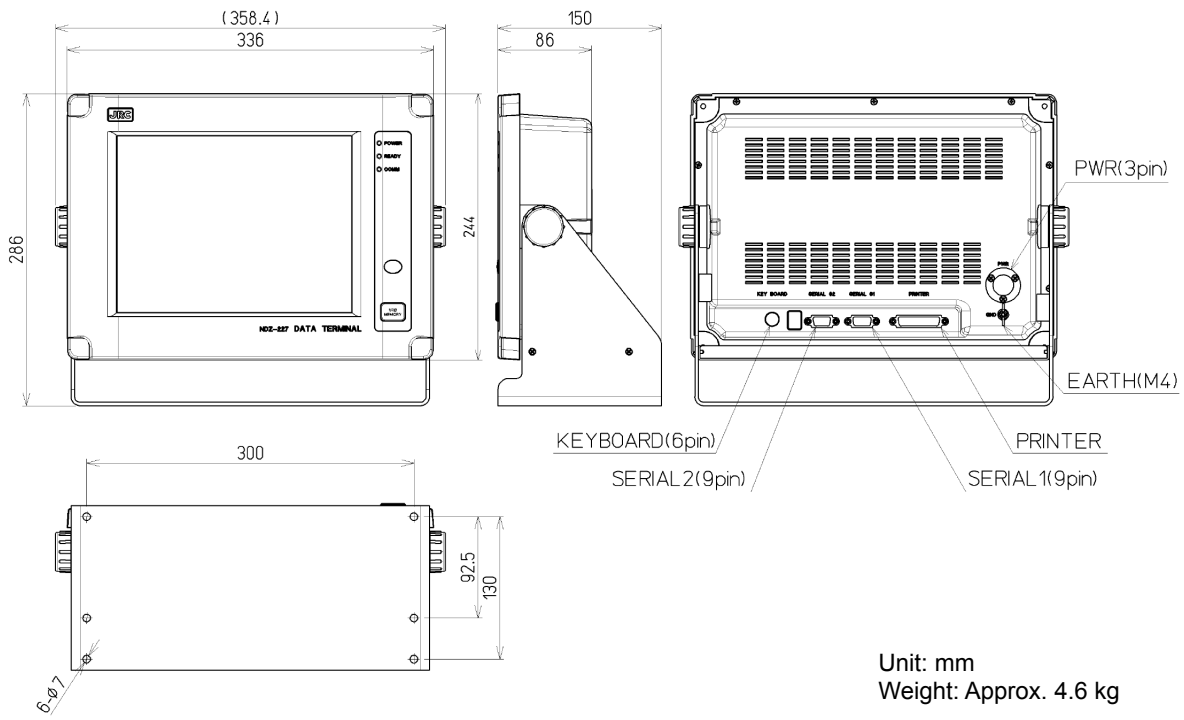

(8) Keyboard (NDF-369)

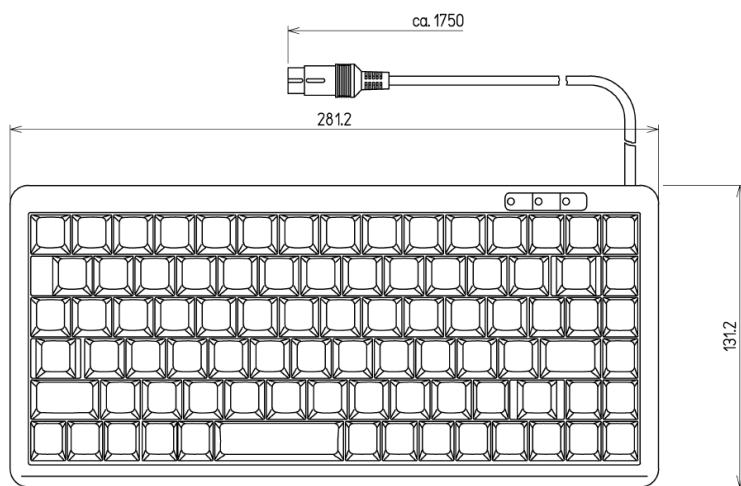

Unit: mm
Weight: Approx. 0.4 kg

(9) Printer (NKG-800)

- Desktop type

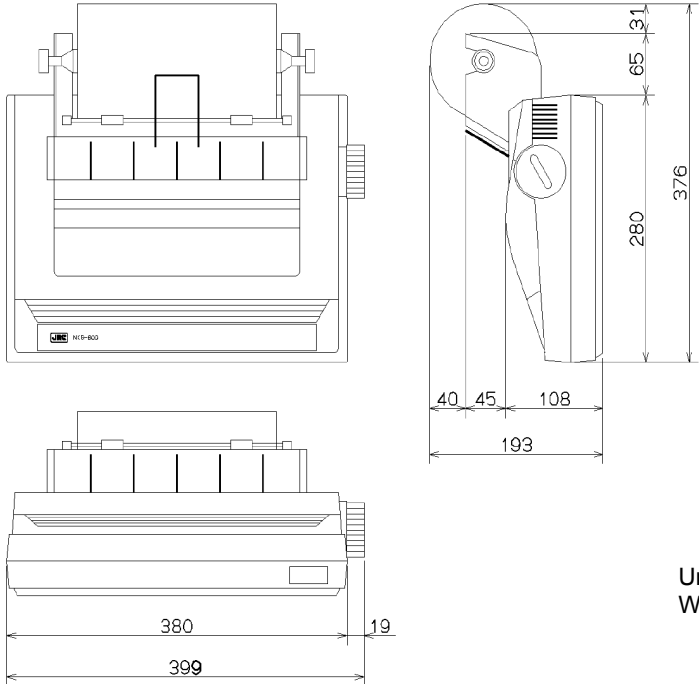

Unit: mm
Weight: Approx. 3.7 kg

(1 0) Printer (NKG-900)

- Desktop type

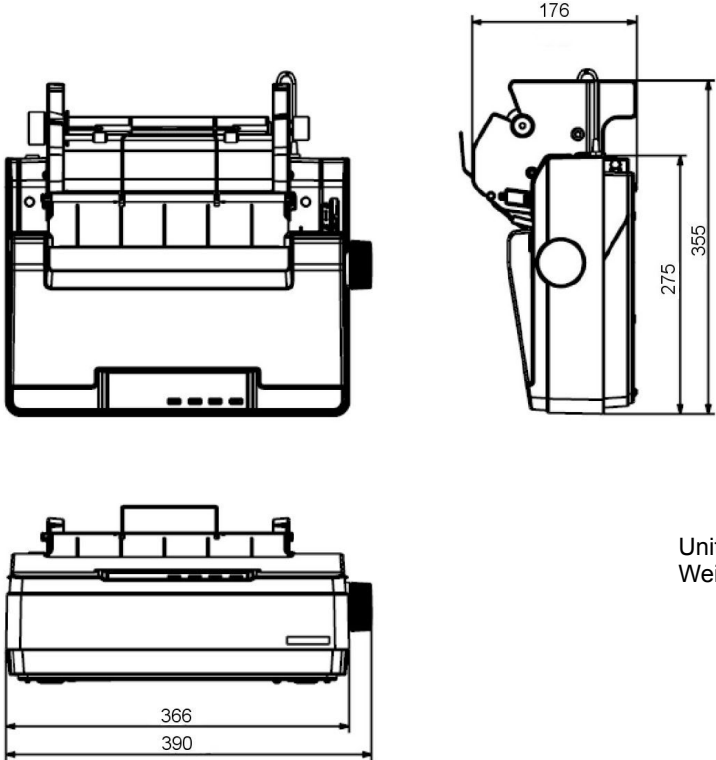

Unit: mm
Weight: Approx. 4.8 kg

Equipment Overview

(1 1) Printer (DPU-414)

● Desktop type

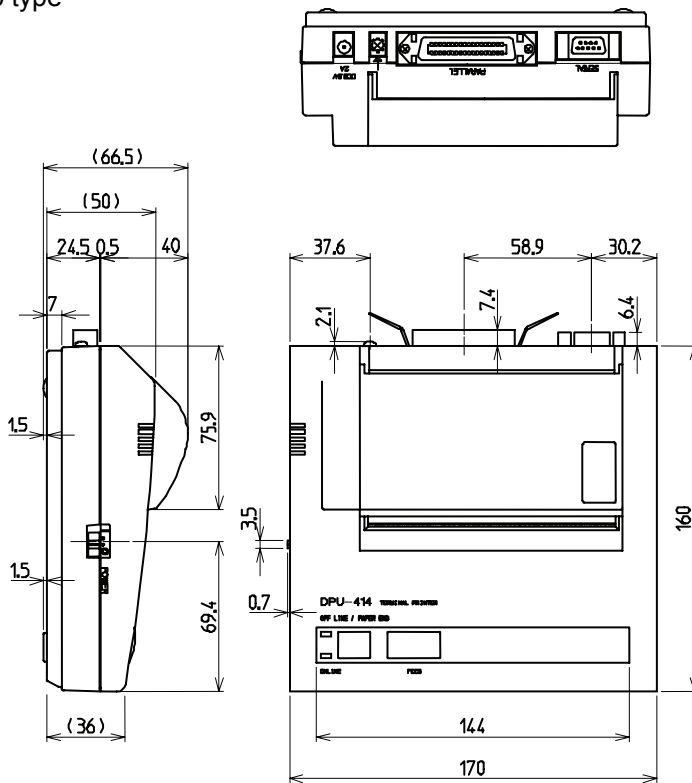

Unit: mm
Weight: Approx. 0.6 kg

(1 2) Printer (NKG-91)

● Wall mount type

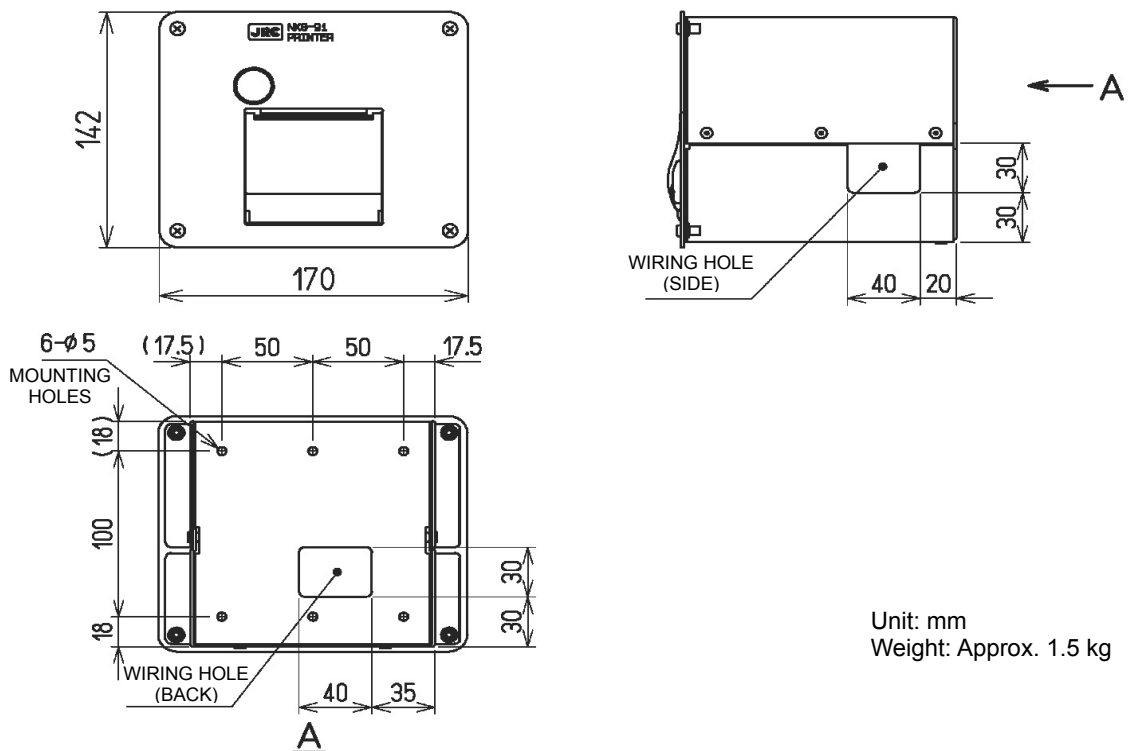

Unit: mm
Weight: Approx. 1.5 kg

● Flash mount type

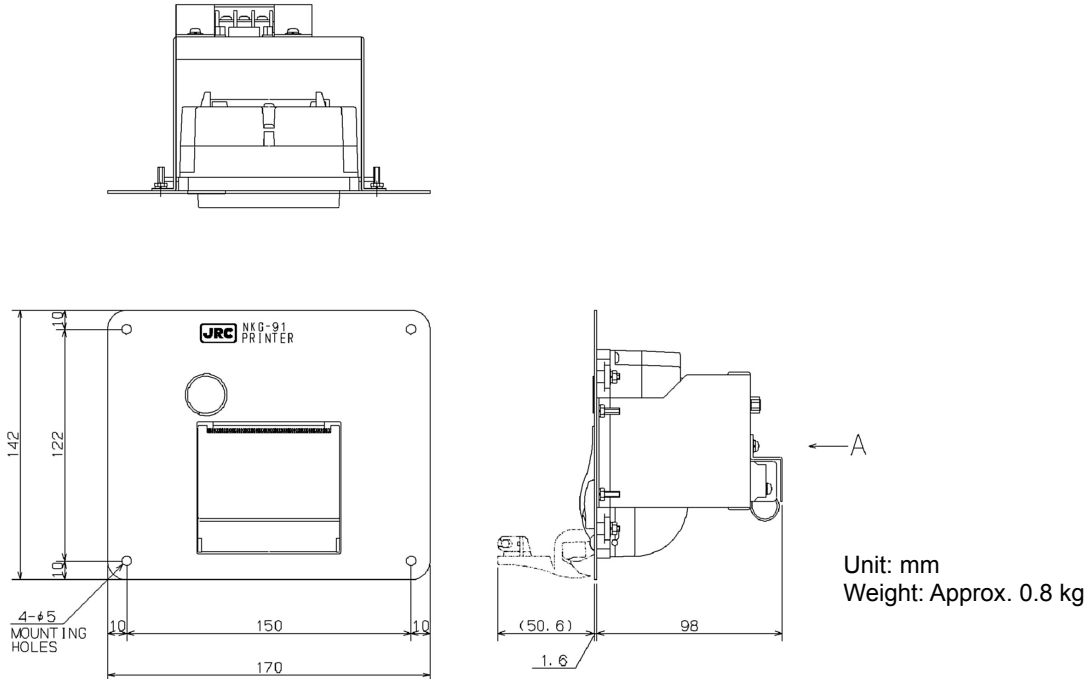

(1 3) AC/DC Power Supply (NBD-2150)

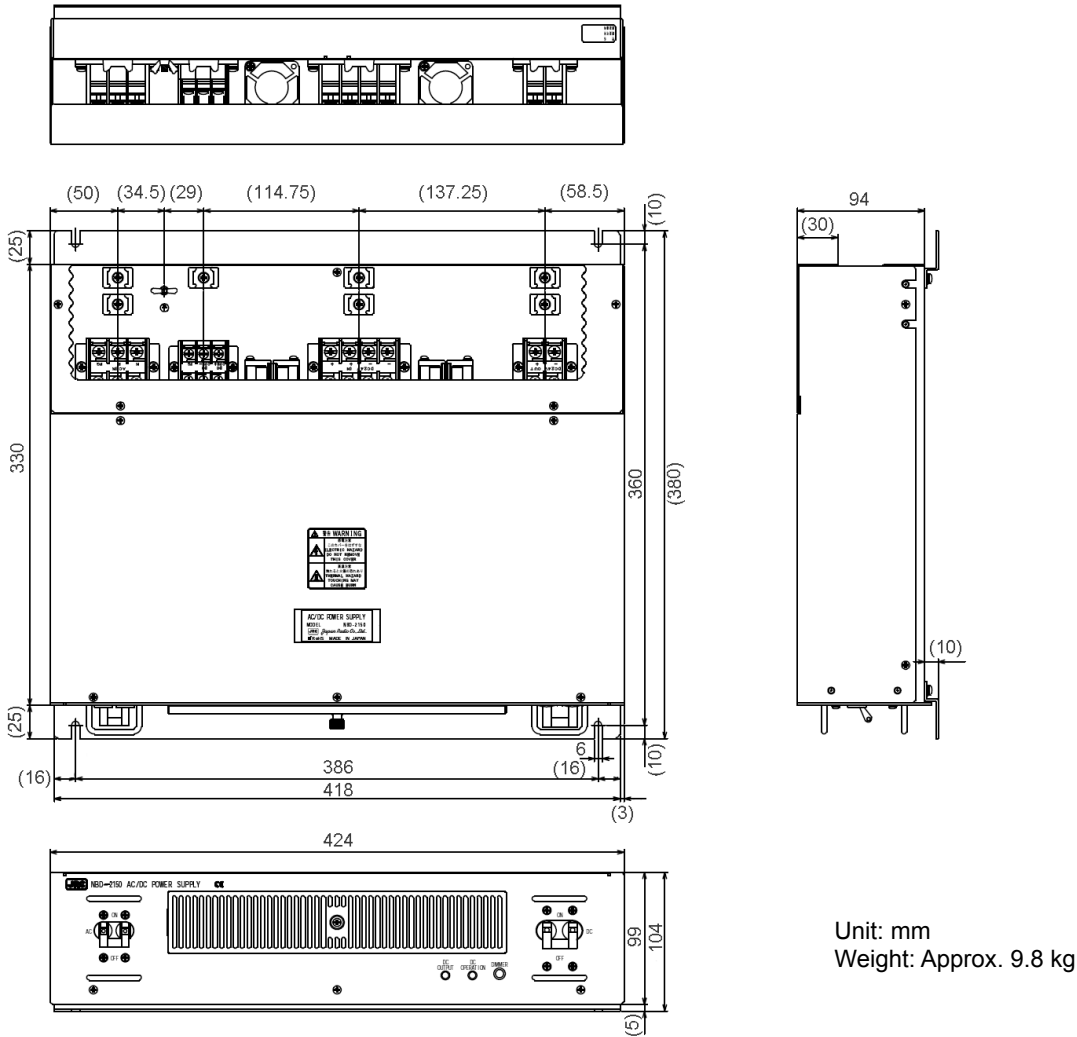

Equipment Overview

(1 4) Battery Charger (NBB-714)

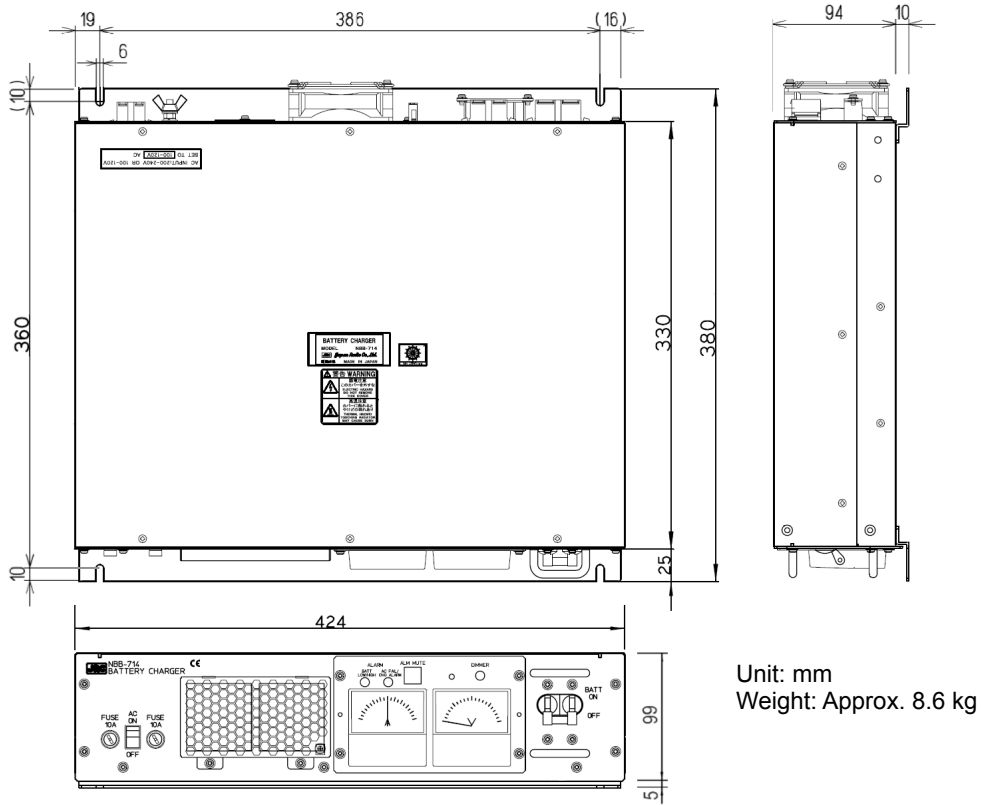

(1 5) Battery Charger (NBB-724)

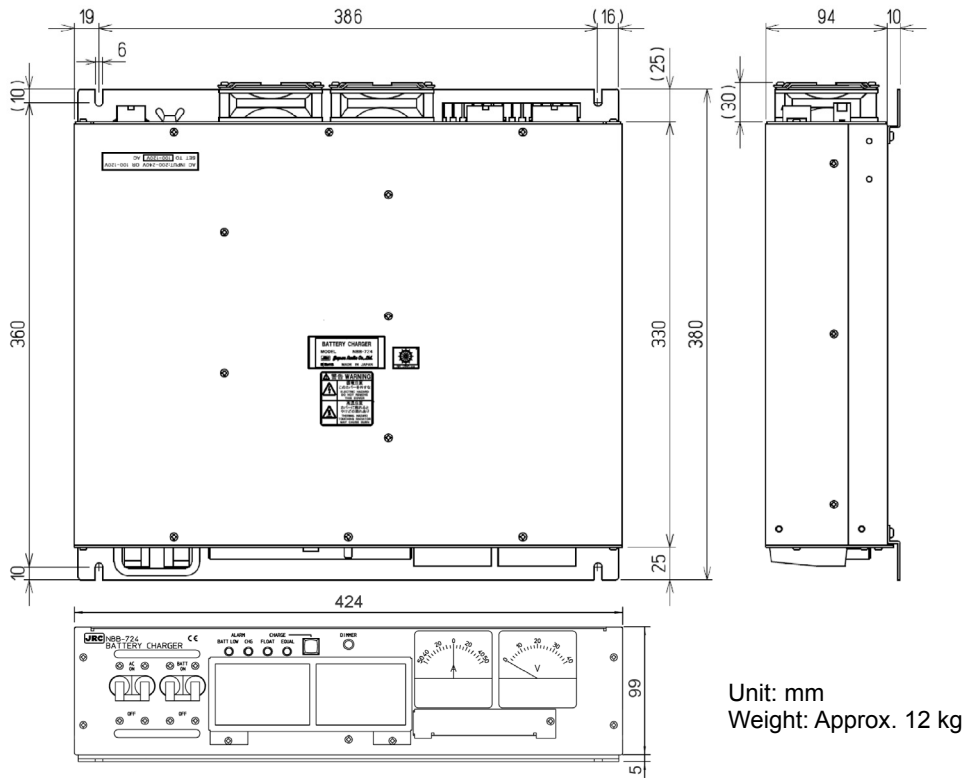

1.5 Block diagram

1.5.1 DSC model

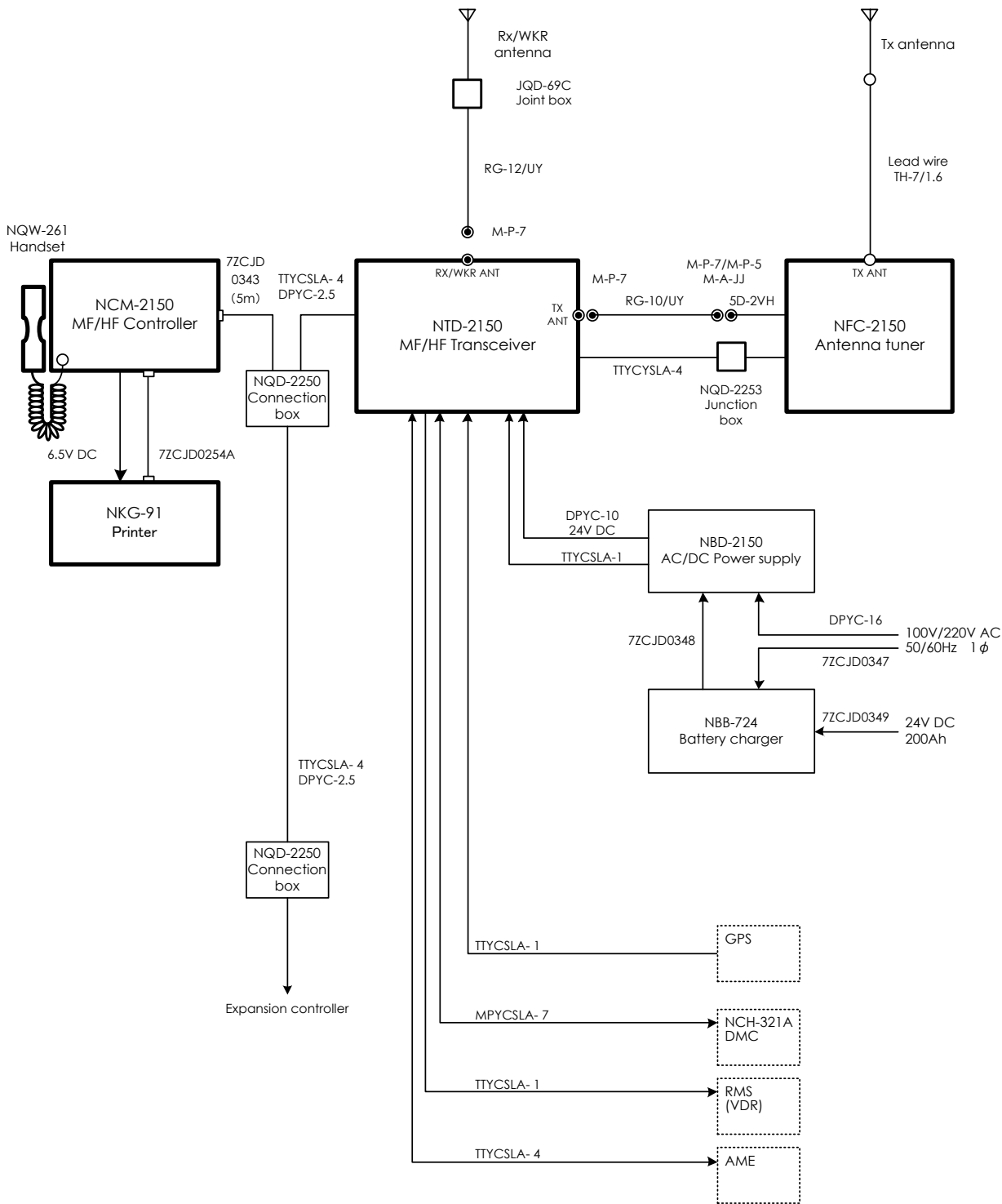

1.5.2 DSC/NBDP model

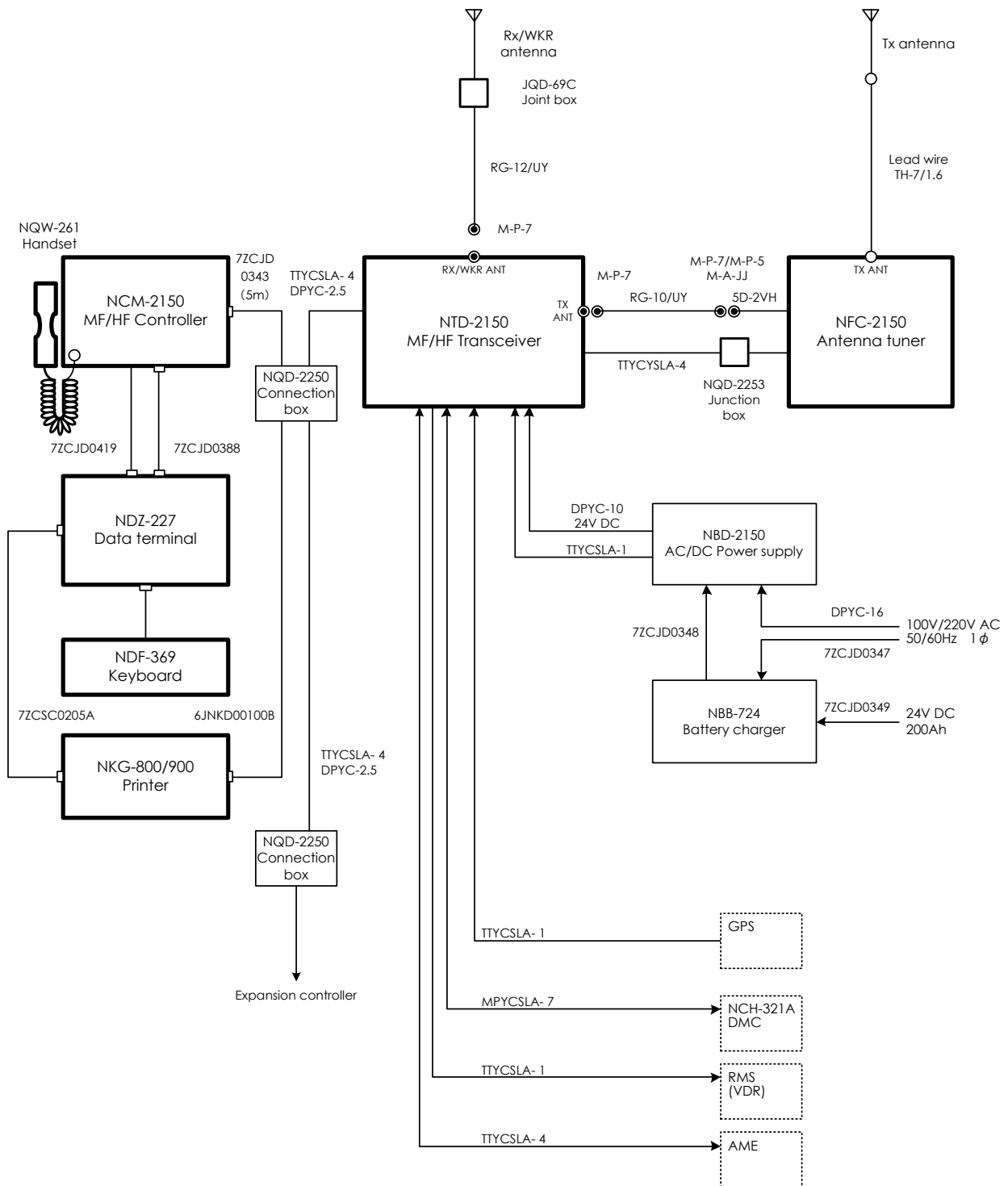

2. NAMES AND FUNCTIONS

2.1 Controller (NCM-2150)

The controller parts and their functions are described below.

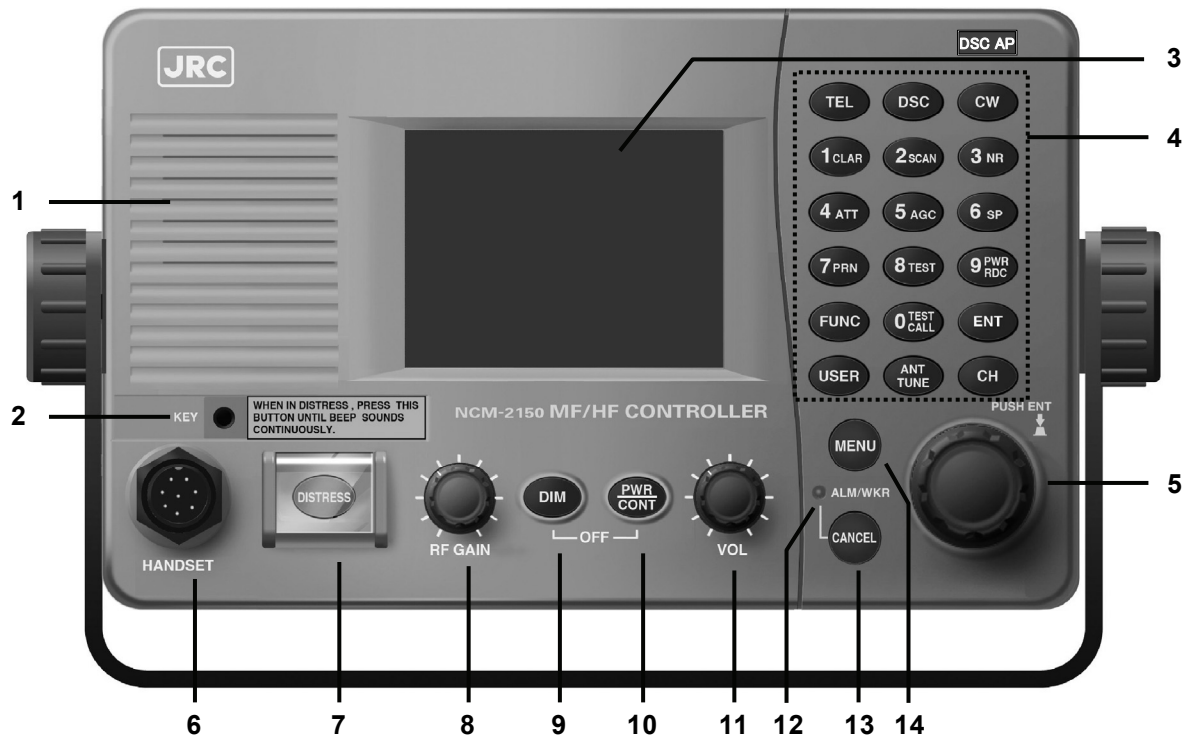

1. Internal loud speaker
2. Jack for telegraph in continuous wave (CW) mode
3. Black and white liquid crystal display unit
4. Numeric keypad (10-key) and function keys

In addition to entering numeric values, when combined with the FUNC key, the keys have the following functions.

- **TEL** ... Sets TEL mode with the last or default frequency.
- **DSC** ... Sets DSC mode with the last or default frequency.
- **CW** ... Sets CW mode with the last or default frequency.
- **1CLAR** ... Displays the setting screen for the clarifier.
- **2SCAN** ... Displays the scan menu.
- **3NR** ... Displays the setting screen for noise reduction.
- **4ATT** ... Displays the setting screen for attenuation.
- **5AGC** ... Displays the setting screen for automatic gain control.
- **6SP** ... Turns speaker on or off.
- **7PRN** ... Prints the specified screen.
- **8TEST** ... Displays the self-diagnosis menu.
- **9 PWR RDC** ... Switches Tx power between high and low.
- **0 TEST CALL** ... Displays the DSC test call menu.
- **FUNC** ... Enables 10-key functions or changes an active screen.

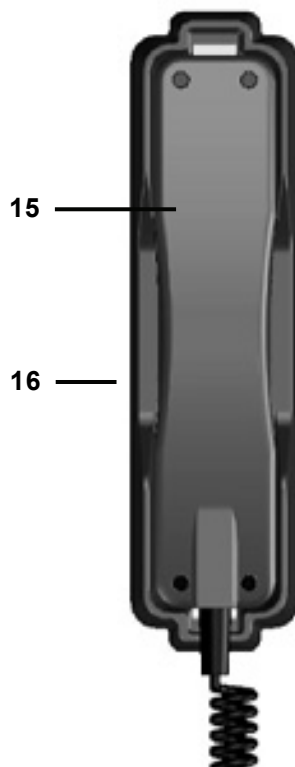

Names and Functions

- **ENT** Enter key.
- **USER** User defined key. Register a frequently used menu to open it quickly.
- **ANT TUNE** Tunes the antenna.
- **CH** Sets the channel input mode (user channel, ITU channel, or free frequency).

5. Jog dial

- On the status display, rotating the jog dial changes the channel or Rx frequency.
- On the operating display, rotating the jog dial changes the frequency on the transceiver setting screen, selects the event on the procedure list screen, or selects the handling menu on the message/event control screen.
- On a menu or popup screen, rotating the jog dial moves the cursor position or screen contents. When selecting a button or an item on the screen, rotate the jog dial until the cursor is on it and then press the jog dial.

Note Pressing the jog dial works as with the Enter key.

6. Handset connector

7. DISTRESS key (Under a clear cover with spring)

When in distress, sends a DSC distress alert when pressed and held for 4 seconds.

8. RF GAIN control

Adjusts the sensitivity level.

Note RF GAIN is set to maximum just after DSC or TLX mode is set, regardless of the position of the control.

9. DIM (Dimmer) key

Adjusts dimmer level (Max → Typ → Min → Off) of the LCD display and key switches. Additionally used to put into sleep mode by pressing it in combination with the **PWR/CONT** key at the same time (a confirmation screen is displayed).

- Note**
- The adjusted dimmer level is not saved. When the controller is powered off and on again, the dimmer level is always set to Typ (default).
 - If a DSC message is received, the dimmer adjustment cycle becomes "Max → Typ → Typ → Typ" while the receiving alarm is activated.

10. PWR/CONT (Power/Contrast) key

Turns on the equipment or changes the controller from sleep mode to standby. Once turned on, this key is also used to adjust the LCD contrast.

11. VOL (Volume) control

Adjusts volume of built-in loud speaker.

12. ALM/WKR lamp

Lights up red on any malfunction detected in the equipment or after sending a DSC distress alert, or blinks red on receiving a DSC call. Lights green to indicate the DSC watchkeeping receiver is operating while the equipment is in sleep mode.

13. CANCEL key

Cancels menus, a procedure on the operating display or stops alarms.

14. MENU key

Displays menu list.

15. Handset

When using in radiotelephone mode, press and hold the PTT key to talk.

16. Cradle (for handset)

2.2 Controller's display

The LCD screen on the controller changes according to current conditions. This section describes the status display, operating display, FUNC menu, and main menu screens.

2.2.1 Status display

1	11
2	ID 431001234 Occ Dc 23:59 (UTC)	12
3	Pos 89° 59.0123' N 179° 59.6789' E@23:59 (EXT)	13
4	TEL ITU- 401 * DUP.	14
5		15
6	L RX 4357.0 kHz	16
7	T	17
8	ON TX 4065.0 kHz	17
9	SIG (12) (N2)	18
10	WKR scan bands: NonDST: MENU + 1 2 4 6 8 12 16MHz DROBOS: MENU + 2 EdtDST: MENU + 3	19

- Occupied mark. Indicates another controller has the access rights.
 - Indicates the ship's MMSI.
 - Indicates the ship's position and that time.
 - Indicates the communication mode and channel.
 - Indicates the receiver is scanning.
 - Indicates the Tx power condition (reduction settings) as follows.
 - High : (Blank)
 - Low : **L**
 - Indicates the following conditions if Tx frequency is not tuned.
 - Not tuned : Blinks
 - Tuning : Lights
 - Tuned : (Blank)
 - Indicates transmission status (PA power).
 - When in reception or standby, indicates strength of received signal (S meter), or when in transmission, indicates strength of transmitted signal (TX meter) in one of the pre-set units shown below.
 - Tx power (PWR)
 - Antenna current (Ia)
 - PA voltage (Vc)
 - PA current (Ic)
 - Key information (KEY)
- Note: When transmitting in ARQ mode, KEY is displayed regardless of the above mentioned setting.
- Additionally, the right icon indicates the built-in loud speaker is on or off. The mark of **SO** indicates the squelch is on.
- Indicates the frequency (band) the DSC watch keeping receiver is monitoring for distress and safety calls.
 - Indicates the equipment is running on DC power.
 - Indicates current time as follows:
 - Universal time coordinated : UTC
 - Local time : LT
 - Indicates the source of the ship's position information as follows.
 - External device (e.g. GPS) : EXT
 - Manual input : MAN
 - No input : OFFLINE
 - Indicates the user channel in use is transmitted at the band power level because the channel power is not registered.
 - Indicates channel or frequency is duplex for communicating with a coast station.
 - Indicates the reception frequency.
 - Indicates the transmission frequency. TX mark is highlighted when transmitting.
 - Indicates the reception status (attenuation, AGC, noise reduction).
 - Indicates the operation guidance (shortcut) to send the DSC messages.
 - NonDST: To send a non-distress call, holding down the **MENU**, press **1** key.
 - DROBOS: To send a drobose call, holding down the **MENU**, press **2** key.
 - EdtDST: To edit & send a distress call, holding down the **MENU**, press **3** key.

2.2.2 Operating display

(1) General

After setting the frequency, pressing PTT key in TEL mode, sending/receiving messages in DSC/TLX mode, and things like that, the controller shows the operating display as follows.

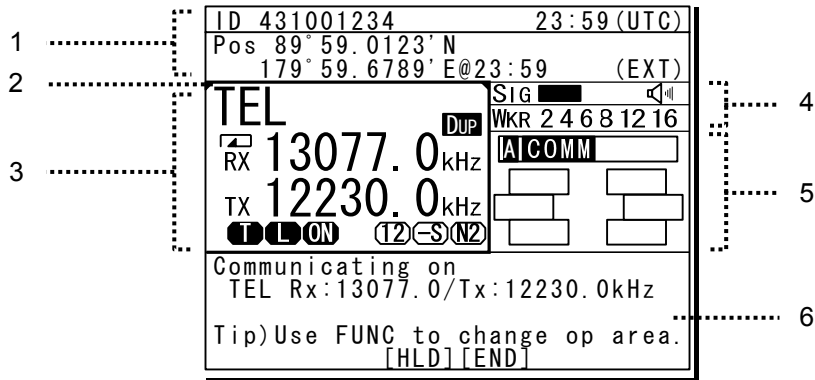

1. Indicates the MMSI and the latest position and that time.
2. Indicates an focused screen with \blacktriangledown \blacktriangleleft sign and thick-frame, i.e. the operating display is divided into three screens as below, where the focused screen can be moved using the **FUNC** key for clockwise.
4. Indicates the S meter (or TX meter), and watchkeeping receiver monitoring frequencies mentioned above.
5. Indicates the existing procedures. If the procedure is under operation (active), \square mark is added in the box frame. Further, if other procedures on hold exist, they are indicated in the other box frames and are selectable to operate at any time. And while this screen is focused, the turning dial animation is shown as below.

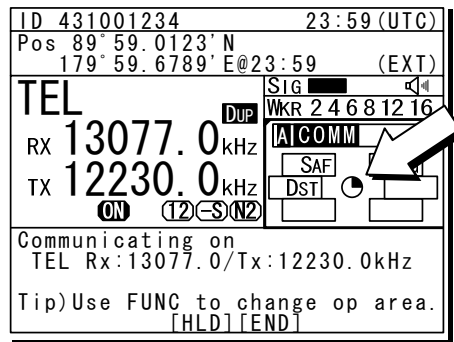
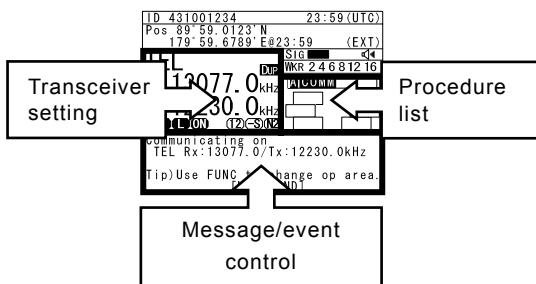



3. Indicates the transceiver setting screen similar to the status display. Icons on this area are as follows.
 - Scanning : \blacktriangleleft
 - Not tuned yet : **T**
 - Tx pwr reduction (low) : **L**
 - Turned the PA ON : **ON**
 - Attenuation (dB) : **(6) (12) (18)**
 - AGC (Fast/ Slow) : **(F) (S)**
 - Noise reduction (NR1/NR2/BC) : **(N1) (N2) (BC)**
6. Indicates the content and the handling menus of the procedure located at the top of the procedure list screen.

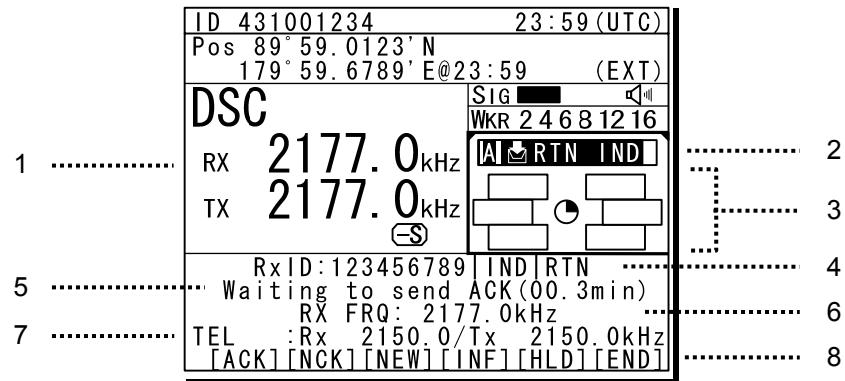

Note During operating an active procedure, any functions such like the DSC automatic acknowledgement become invalid to avoid the ongoing communication interruption.

(2) Operating display of DSC calls

When communicating using DSC messages, the controller shows as follows.



1. Indicates the transceiver setting screen similar to the status display mentioned above.
2. Indicates the message type according to the following components.
 - Call direction : Calling event - 
 - Called event - 
 - Category : RTN... routine
 - SAF... safety
 - URG... urgency
 - DST... distress
 - Address type : IND... individual
 - ARE... area
 - GRP... group
 - DST type : ALT... distress alert
 - RLY... distress relay
 - CNL... distress cancel
 - ACK... distress ack
 - Other type : TST... safety test
 - POS... safety position
 - POLL... routine polling
 - EOS... routine ind w/o ack

Additionally, indicates COMM if started communication without using DSC.
3. Indicates procedures information of active or on hold with the DSC categories or COM.
 - ACK : Accepts the call and sends ACK
 - NCK : Sends "unable to comply"
 - NEW : Sends ACK with new work FRQ
 - INF : Indicates the detail info
 - HLD : Makes the active proc on hold
 - END : Terminates the procedure
4. Indicates the message info as follows;
 - Destination/source ID to comm with: TxTO/RxID
 - Address type: IND, Area, GRP, All
 - Category or DST type: RTN, SAF, URG, DST, DISTRESS ALT, DST RLY,
 - Other information: ACK, NACK
5. Indicates the DSC message status with the elapsed time of the top frame procedure. Additionally the following special marks may be indicated on this line.
 -  ... Indicates when including the ECC error in the message.
 -  ... Indicates when the DSC procedure is started by receiving a delayed ACK without a calling message.
6. Indicates the message received frequency.
7. Indicates the subsequent frequency if exist.
8. Indicates the handling menus. This figure shows the following menus.
 - ACK : Accepts the call and sends ACK
 - NCK : Sends "unable to comply"
 - NEW : Sends ACK with new work FRQ
 - INF : Indicates the detail info
 - HLD : Makes the active proc on hold
 - END : Terminates the procedure

Note

- When sending the "able to comply" acknowledgement against the received message requesting the TEL communication, lifting handset is also available as a substitute for selecting the ACK handling menu.
- When selecting the NEW or NCK menu, the dedicated popup screen is appeared.
- When sending an acknowledgement automatically to the receiving calls such as position request, safety test, polling, or the call requesting communication with an invalid frequency, the above screen is shown and starts sending automatically. After finishing it, that screen is closed automatically.

2.2.3 Function screen and key operations

The functions assigned to the number keys are temporarily enabled by pressing the **FUNC** key in the status display or holding down the **FUNC** key and pressing the number key.

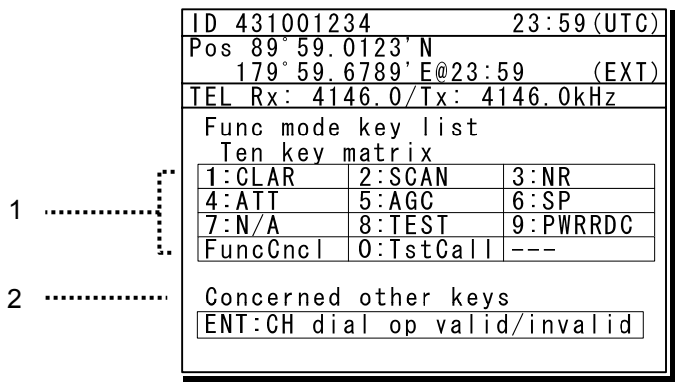

- 1. Indicates the enabled number key and its function when the FUNC key is pressed in the status display. Pressing the number keys here operates the function for that key as shown at the right.
 - 1 CLAR : Displays the clarifier adjustment menu
 - 2 SCAN : Displays the scan menu
 - 3 NR : Displays the noise reduction menu
 - 4 ATT : Displays the attenuation menu
 - 5 AGC : Displays the AGC menu
 - 6 SP : Turns the built-in loud speaker on or off
 - 7 N/A : PRN is valid only on specific menus.
 - 8 TEST : Displays the self-diagnosis menu
 - 9 PWR RDC : Displays the Tx power reduction menu
 - 0 TstCall : Displays the DSC test call menu
 - FuncCncl: Closes this screen

- 2. Indicates that pressing ENT enables or disables the use of the jog dial to change the frequency and channel in the status display.

Note - During the operating display mentioned above, the function screen is not appeared. In this case the **FUNC** key alone is available to select the screen. However note that the holding down the **FUNC** key and pressing the number key is also valid.
 - In the following situations the function assigned to the function key cannot be used.

Equipment status	1CLAR	2SCAN	3NR	4ATT	5AGC	6SP	7PRN	8TEST	9 PWR RDC	0 TEST CALL
DSC mode	●		●							
While printing	●	●	●	●	●	●	●	●	●	●
During self-diagnosis	●	●	●	●	●	●	●	●	●	●
While scanning	●						●		●	
While alarm screen is displayed	●	●	●	●	●	●	●	●	●	●

2.2.4 Menu screen

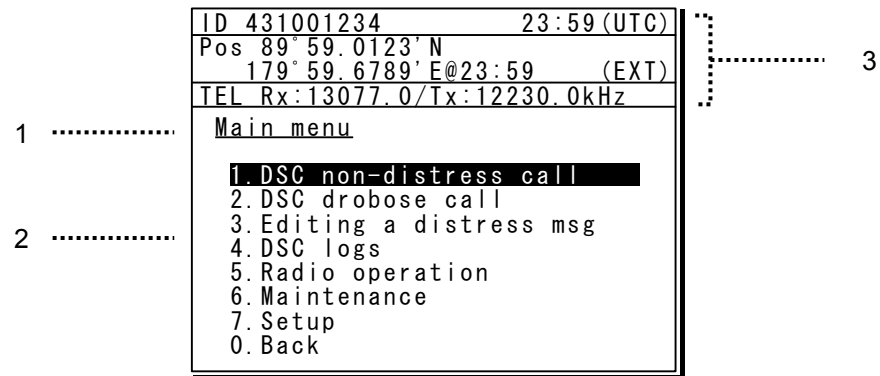

1. Indicates the current menu name.
2. Indicates the menu content. The cursor line or position is highlighted. Select items with the jog dial and press ENT to confirm.
3. Indicates the main radio information the same as the status display. Also indicates the following marks in the frequency information area according to the conditions.
 - T** : Tuning condition
 - L** : Tx power is low

2.3 Data terminal (NDZ-227)

This section describes the name of each part in the data terminal and the function.

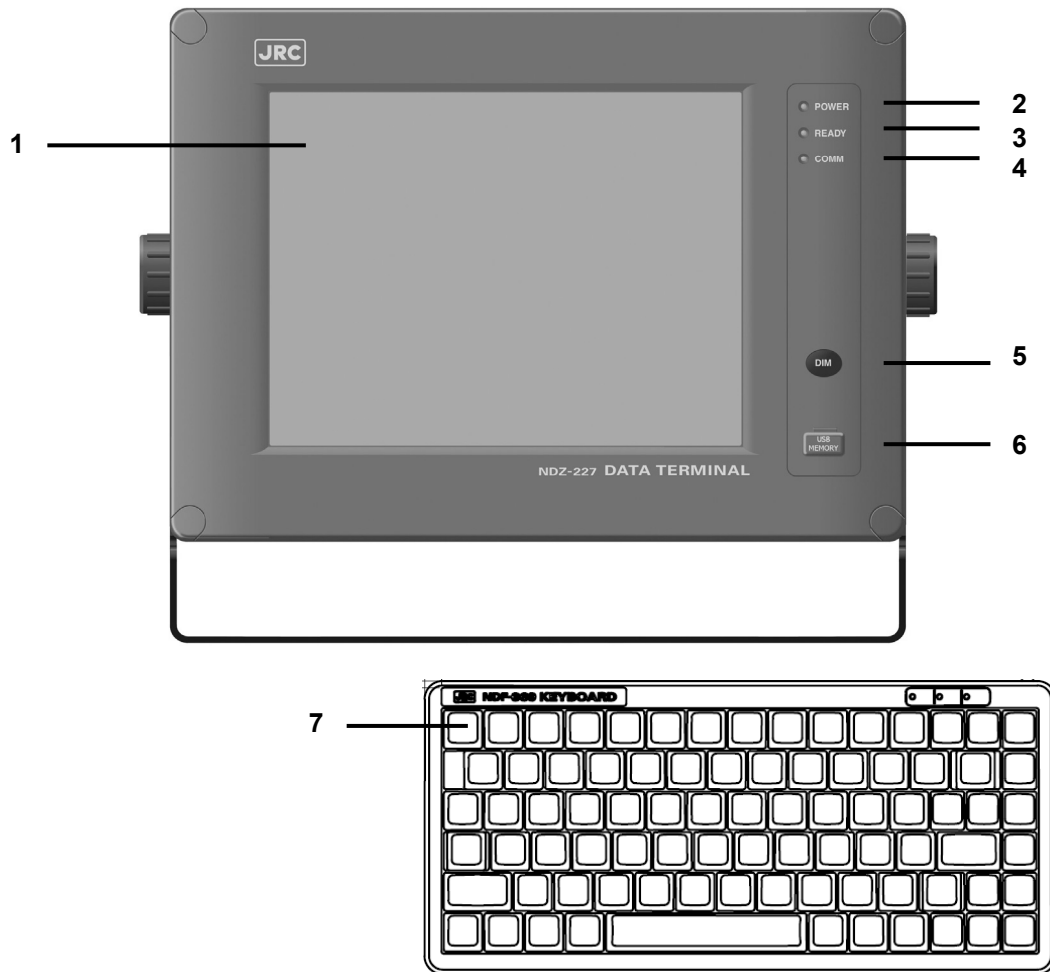

1. Color liquid crystal display (LCD) unit

2. POWER lamp

This lamp lights to green while operating the data terminal, and blinks during the sleep.

3. READY lamp

This lamp lights to green while serial communications are being normally done. And, when abnormality occurs, it turns off.

4. COMM lamp

This lamp lights to green while communicating in ARQ or FEC mode.

5. DIM (Dimmer) key

This key adjusts the brightness of the LCD screen and the lamp by four stages (high, middle, low, and off).

6. Connector for the USB memory with the water-proof rubber cap

Pull out the rubber cap and connect the USB memory.

7. Keyboard

2.4 Display of data terminal

The content displayed on the LCD screen in the data terminal is different according to the situation. This section describes a regular screen, the telex communication screen, and the message file edit screen.

2.4.1 Regular screen

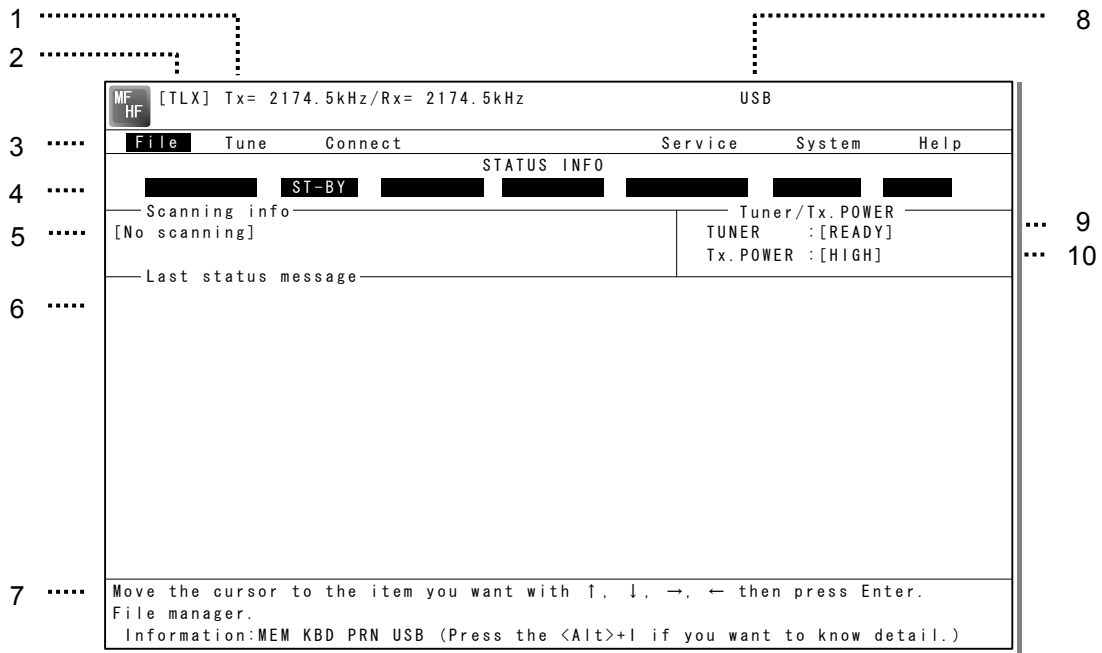

- Indicates the Tx and Rx frequencies.
- Indicates the communication mode.
- Indicates the main menu.
When pressing the Enter key, indicates the drop-down menu of the main menu pointed by the cursor.
※Telex mode only.
- Indicates the conditions of the telex communication.
※Telex mode only.
- Indicates the scanning information in telex mode. When restarting scanning after sending a DSC Auto-ACK or powering off/on, indicates “Running now” instead of the detail information.
※Telex mode only.
- Indicates the operation result such as the self-diagnosis.
- Indicates the guide according to the cursor position. Moreover, the locating faults are displayed if any errors occur.
 - Information: MEM : Internal memory
 - Information: KBD : Keyboard control
 - Information: PRN : Printer
 - Information: USB : USB Memory
- Indicates that the connected USB memory is available. Additionally, “ACS” is shown if some time is needed to mount the USB memory.
- Indicates the antenna tuning condition.
 - READY : Tuned
 - NOT READY : Not tuned
- Indicates the power reduction setting.

2.4.2 Telex communication screen

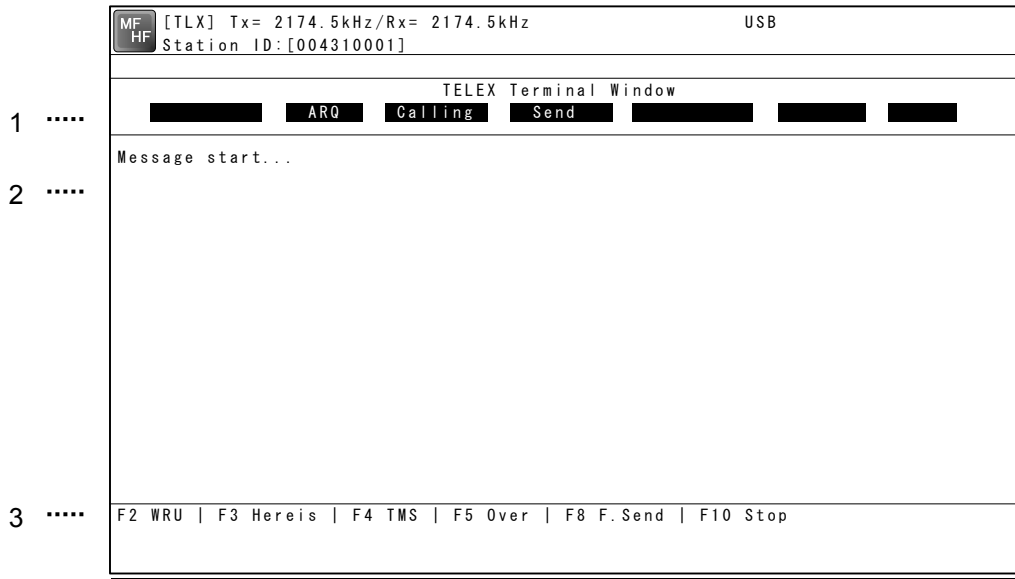

1. Indicates the operating condition of the telex communication from the left of each segment as follows.
 - 1) In the autotelex mode, when the free channel signal of the coast station is detected, indicates the "Free Sig".
 - 2) Indicates the communication mode (ARQ/CFEC/SFEC).
 - ※ Indicates "ST-BY" in the standby condition.
 - 3) Indicates "Calling" at the master station, and "Called" at the slave station.
 - 4) Indicates "Send" at the information sending station, and "Receive" at the information receiving station.
 - 5) Indicates "Phasing" while calling and connecting the communication channel and "Rephasing" while reconnecting the channel after the channel is disconnected due to the channel condition in ARQ mode.
 - 6) Indicates "Repeat" in ARQ mode if requested to send the each block or the control signal again.
 - 7) Indicates "Traf" while sending or receiving information and "RQ" while sending or receiving RQ signal.

2. Indicates the telex message or the name of the executed function key.

3. Indicates the usable function keys guide. Each meaning is as follows.
 - F2 WRU : Requests the answer-back code to the corresponding station.
 - F3 Hereis : Sends the answerback code of own station.
 - F4 TMS : Sends the date and the time information.
 - F5 Over : Exchange the sending and the receiving condition.
 - F6 POLL : Acquires the sending right if the corresponding station (sending) tries to finish the communication in ARQ mode.
 - ※ It is available only when the corresponding station is using the modem made of our company.
 - F8 F.Send : Sends a message file.
 - F10 Stop : Finishes the telex communication.

2.4.3 Message file edit screen

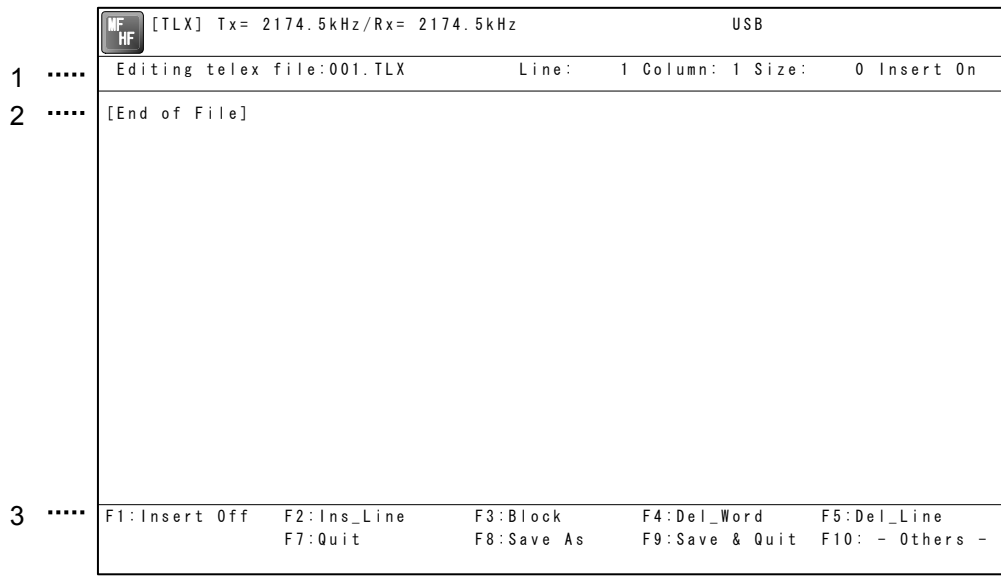

1. Indicates the state of the edit screen as follows.
 - Editing telex file : File name
 - Line : Line position of cursor
 - Column : Row position of cursor
 - Size : Capacity of file
 - Insert On/Overwrite : Input mode (insert/overwrite)
2. The message file is edited here.
3. The list of the function key is displayed by the following content separately for two groups.
 - Group 1
 - F1 : Insert On/Off
 - F2 : Ins_Line
 - F3 : Block
 - F4 : Del_Word
 - F5 : Del_Line
 - Group 2
 - F6 :
 - F7 : Quit
 - F8 : Save As
 - F9 : Save & Quit
 - F10 : - Others -

3. INSTALLATION

CAUTION



To install this equipment, contact our service center or agents.
Special knowledge on selecting the place where the antenna is to be mounted and setting the ID number (MMSI) assigned to the ship is required in addition to installing the equipment.

4. OPERATION

This chapter describes basic operations of the controller and the data terminal, radiotelephone communications, telex communications, DSC calling procedures, and other radio functions.

4.1 Operation overview

4.1.1 Operation of the controller

Basically, the controller is operated with the numeric keypad (10key), the **MENU** key, and the jog dial for other than the telex communication. The following is an overview of their operation.

- When two controllers are connected, only one controller having the access right can operate the radiotelephone, except for sending a distress alert, changing audio volume, and changing display conditions. (Unless otherwise mentioned, the instructions below are for the controller with the access rights.)
- To obtain the access right at a controller without access rights, press ENT to get the access right unless the other controller is being operated (PTT/KEY ON or menu operations).
- The **DISTRESS** key is always available. (The DISTRESS key has the highest priority.)
- On the status display or the operating display, the communication frequency or channel can be set by using the number keys or if the transceiver setting screen is focused on, setting it by rotating the jog dial is also available.
- Pressing the **TEL DSC** or **CW** key changes the communication mode. If the screen displays in the menu, immediately shows the status display or the operating display, and also the channel input mode changes to the free frequency mode. Additionally, the communication mode can be changed to the AM mode to listen to the radio broadcasting or to the DATA mode to communicate using the intership fax
- When the communication mode is set to TEL or CW, pressing the same communication mode key turns the PA on and off. (When the PA is on, **ON** mark appears.)
- All functions can be accessed using the **MENU** key, jog dial, and the dedicated keys/controls. (See the menu tree on the next page.) Further, screens in the menu tree indicated by "Printable" can be printed from a printer connected to the controller or the data terminal by pressing and holding the **FUNC** key and then pressing the **7PRN** key.
- Pressing or pressing and holding the **FUNC** (function) key and a number key allows rapid access to that function.
- There are two ways to access main menu items. After pressing the **MENU** key to display the main menu, use either the jog dial to move the cursor to the desired item and press ENT to select it, or select the item by pressing the respective number key. (Ex: For Self diagnosis (6.1.1 Transceiver), press **MENU**→**6SP**→**1CLAR**→**1CLAR**)
- Any menu can be assigned to the **USER** key to open it with a single touch of a button.
- Normally the **ANT TUNE** key is always enabled.
- Pressing the **CH** key changes the channel input mode to the User ch, ITU ch or to the free frequency. This key is enabled when showing the status display or the operating display.
- Pressing the **CANCEL** key in any menu moves the display up one level in the hierarchy (or to the status display). The same results can be achieved by selecting "0. Back" when available on-screen. Further, pressing the **CANCEL** key on an input line will clear the entered data.
- Pressing the **MENU** key in any menu opens the main menu. Also, pressing **MENU** while in the main menu returns to the status display or the operating display.
- Dialog boxes (popup screens) are opened when necessary and operations can be done in the dialog box.
- When using DSC calls, to distinguish the messages or conditions, some specific alarms are provided as listed after the menu tree below.

Operation

Menu tree

Main Menu	Hierarchical Menu 1	Hierarchical Menu 2	Shortcut Key	Note		
1. DSC non-distress call			MENU+1 _(RTN) FUNC+0 _(Test)			
2. DSC drobose call			MENU+2			
3. Editing a distress msg			MENU+3			
4. DSC logs	4.1 Received distress	(Received message screen)		Printable		
	4.2 Received others	(Received message screen)		Printable		
	4.3 Transmitted calls	(Transmitted message screen)		Printable		
5. Radio operation	5.1 User channel list (index)	5.1 User channel list (table)		Printable		
	5.2 ITU channel list (index)	5.2 ITU channel list (table)		Printable		
	5.3 Mode					
	5.4 Receiver	5.4.1 Auto gain control		FUNC+5		
		5.4.2 Noise reduction		FUNC+3		
		5.4.3 Attenuation		FUNC+4		
		5.4.4 Clarifier		FUNC+1		
		5.4.5 Squelch				
		5.4.6 CW bandwidth				
		5.4.7 Scan		FUNC+2		
5.5 Transmitter	5.5.1 Power		FUNC+9			
	5.5.2 Tune power					
	5.5.3 Auto tune start					
6. Maintenance	6.1 Self diagnosis	6.1.1 Transceiver (ATU/PA/TRX/WKR MODEM)	FUNC+8	Printable		
		6.1.2 Controller/DTE		Printable		
		6.1.3 Transceiver log		Printable		
		6.1.4 Controller/DTE log		Printable		
		6.1.5 DSC/NBDP loop		Printable		
		6.1.6 Printout				
	6.2 Alarm information	Alarm history		Printable		
6.3 Software version			Printable			
7. Setup	7.1 Date & time	7.1.1 Date				
		7.1.2 Present time				
		7.1.3 Display form				
	7.2 POS/TIME	7.2.1 Own position				
		7.2.2 UTC of position				
	7.3 My controller	7.3.1 LCD adjustment 1. Contrast 2. Dimmer 3. Screen saver		FUNC+6 _(SP)		
			7.3.2 Sound 1. Operation 2. Notification level 3. Sidetone			
			7.3.3 User key assign			
		7.3.4 Tx meter				
		7.3.5 Data transfer				
		7.3.6 Menu shutdown				
		7.3.7 CH search ref				
		7.4 User channels (index)	7.4 User channels (table)			Printable
	7.5 DSC/WKR condition	7.5.1 Automatic ACK 1. Test call 2. Position RQ call 3. Polling call 4. Individual call				
			7.5.2 WKR scanning FRQ			
			7.5.3 DSC alarm setting 1. Safety/Routine RX ALM 2. Distress RX ALM			
				7.5.4 Medical use		
		7.5.5 Neutral use				
		7.5.6 Group-ID				
		7.5.7 Inactivity timeout 1. ACKed distress alert 2. RCVed other distress 3. Non-distress call 4. Other communications				
7.5.8 DSC call list						
7.6 Option		7.6.1 Connection			Printable	
	7.6.2 Data out					
	7.6.3 Baudrate					
	7.6.4 Flow control					
	7.6.5 Print direction					

DSC alarm specifications

The following table summarizes the alarm characteristics when communicating particularly in the DSC mode.

Reason for the alarm	Sound	Increase	Shutdown
Receiving a new distress event	Two tones of 2200Hz(250ms) and 1300Hz(250ms)	Yes	Manually
Acknowledging a received distress event	Two tones of 2200Hz(500ms) and 1300Hz(500ms)	No	Manually
Acknowledging a sent own distress event	Two tones of 2200Hz(500ms) and 1300Hz(500ms)	No	Manually
Receiving a new urgency event	Intermittent tones of 2200Hz(250ms) and silence(250ms)	Yes	Manually
Acknowledging a sent urgency event	Intermittent tones of 2200Hz(500ms) and silence(500ms)	No	Manually
Receiving a new safety or routine event	Two tones of 784Hz(1s) and 392Hz(1s)	Yes	Automatically (10s)
Acknowledging a sent safety or routine event	Intermittent tones of 784Hz(1s) and silence(1s)	No	Automatically (10s)
Receiving a DSC message pertinent to an ongoing event	Intermittent tones of 494Hz(100ms), silence(100ms) and 494Hz(1s)	No	Automatically (1 cycle)
Pressing the dedicated distress button	An intermittent tone of 2000Hz(500ms) and silence(500ms)	No	---

Note

If receiving a DSC message with the ECC error, the alarm is stopped automatically. However if the same DSC messages are received repeatedly and the every error is corrected at last, the original alarm may be sounded.

4.1.2 Operation of the data terminal

Basically, the every function concerning the telex mode such as ARQ/FEC communication or scanning can be operated from the data terminal.

- To connect and install the data terminal, setup the 7.6 Option menu of the controller.
- To set the communicate mode to the telex mode, press the Enter key of the keyboard. Additionally, that operation acquires the access right if the controller connected to that data terminal does not have the access right.
- Every function of the data terminal can be operated from the main menu displayed on a regular screen, excluding the screen of communication modes other than the telex, telex communicating screen, the telex file editing screen.
- Because the short-cut key to the table of next page is allocated in each item of the main menu or the drop down menu, it is possible to execute it easily according to few procedures.
- The guide of the item shown with the cursor is basically displayed under the screen in the data terminal.
- While displaying the menu screen on the controller, the data terminal cannot be operated temporarily. Similarly, the controller cannot be operated during the telex communication except the operations of **TEL DSC CW** and **DISTRESS** keys.
- Besides the telex communication in ARQ/FEC mode, the data terminal has other functions such as editing telex messages and the station list, setup of the radio condition, or setup of the display color of the screen.
- The communication using ARQ mode can be started with a specific radio station by inputting the selcal number (ID) and the work frequency.
- The communication using CFEC mode can be started as the broadcasting by inputting the work frequency.
- The communication using SFEC mode can be started as the broadcasting for limited receivers by inputting the selcal number (group ID) and work frequency.
- The telex communication channel can be set by specifying ARQ or FEC in the DSC message. In this case, the telex communication may be started without inputting 9 digits selcal number (ID) and work frequency because those have been already set by the DSC calling.
- Up to 20 stations can be registered in the station list.
- The self-diagnosis of the data terminal is executed from the controller as well as other units.
- The controller outputs the printing data from the printer connected to the data terminal.
- The condition of the data terminal such as the startup or the sleep is synchronized to the controller connected or the system.
- When the data terminal detects any error(s) concerning to the internal flash memory, the keyboard, the printer or the connected USB memory, immediately shows the popup screen and the Information is displayed on the bottom line on the screen until the error is fixed.

Menu tree in data terminal

Main Menu	Short-cut Key	Drop-down Key	Short-cut Key	Remarks
File	F	Edit new file	N	
		Edit existing file	E	
		Rename file	R	
		Delete file	D	
		Copy file	C	
		Initialize USB	I	
		Remove USB	U	
Tune	T	Frequency list	F	Printable
		ITU channel set	C	
		Tx/Rx frequency set	Q	
		Tx tune	U	
		Scanning start (stop)	S	
Connect	C	ARQ	A	
		CALL	C	Option
		AUTOTELEX	T	Option
		CFEC	F	
		SFEC	S	
Service	S	Call logging history	C	Printable
		Station list	S	Printable
		Station database	D	Printable
		Destination list	L	Option
		Sunspot number	N	
		MUF calculation	M	
		Clear status window	R	
System	Y	Config	C	
		Scan speed	S	
		NBDP setup	N	
Help	H			Software version

4.2 Basic communications procedure

The following describes basic radio communication procedures.

4.2.1 Turning on the power

⚠ CAUTION



Do not turn off the equipment when at sea because the SOLAS Convention requires keeping watch on distress and safety frequencies at all times. Always listen to 2187.5 kHz and 8414.5 kHz, and one or more of the following frequencies; 4207.5 kHz, 6312.0 kHz, 12577.0 kHz, or 16804.5 kHz. In class B mode, it is necessary to keep watch only on 2187.5 kHz.

■ Procedure ■

1. Make sure the equipment is connected to a power source and turn on the breaker on the transceiver.

- If the NBD-2150 AC/DC Power supply is connected, turn on its breaker first.
- The controller, transceiver and data terminal start the internal check.
- After the check is finished correctly, the status display appears and becomes receiving condition (standby) on the receiving frequency showing.

Note

- When turning on the controller or the equipment in sleep mode, press **PWR CONT** key for one second.
- Pressing **PWR CONT** key for 6 seconds makes the system reset to restart.
- When two controllers are connected, and one controller is turned on from sleep mode, the status display is displayed immediately without checking operations.
- The start screen of the data terminal is as shown at right.
- If errors are detected during the operation check, the message is displayed. Please inform JRC or our agent of the error contents.

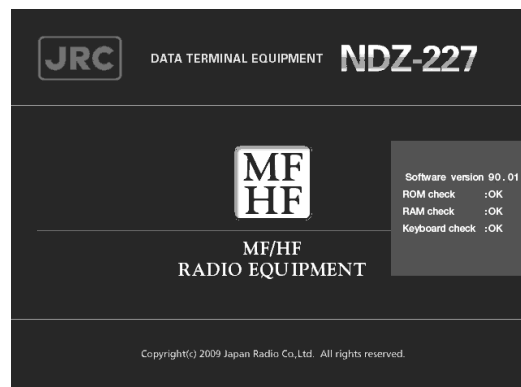
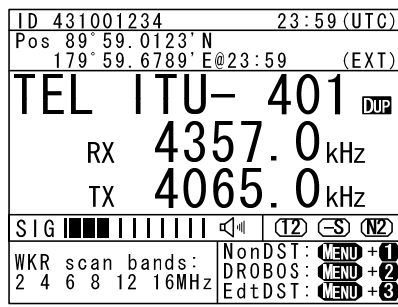
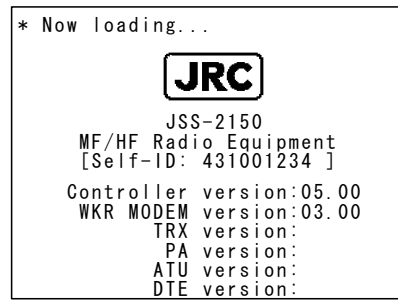

4.2.2 Turning off the power/ Putting into sleep mode

⚠ CAUTION



When completely turning off the power to the equipment, turn off the breaker on the transceiver

■ Procedure ■

Press the **PWR/CONT** key and **DIM** key simultaneously.

After that, the power-off process is activated according to the controllers' status.

- **When using only one controller**
 Select the desired item below on the popup screen shown at right
 - [OK]: Turns off the power. (Puts into sleep (energy saving) mode.)
 - [Cancel]: Returns to the previous screen.

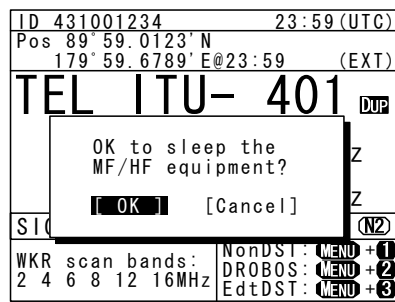

- **When using two controllers**
 On a controller with access rights, select the desired item below on the popup screen shown at right
 - [EQP]: Turns off the power. (Puts into sleep (energy saving) mode.)
 - [CTRL]: Puts the controller into sleep mode and gives access rights to another controller.
 - [Cancel]: Returns to the previous screen.

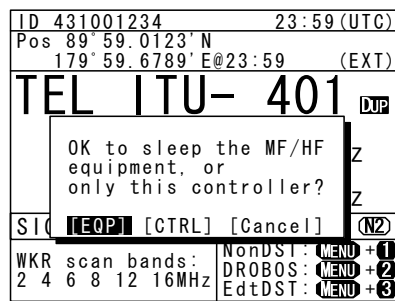

- On a controller without access rights, select the desired item below on the displayed popup screen at right
- [OK]: Puts one controller into sleep mode.
 - [Cancel]: Returns to the previous screen.

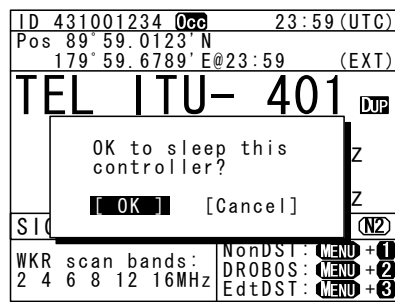

Note

- In sleep mode, the equipment changes to the following statuses.
 - If all the equipment goes to sleep, the ALM lamp lights green to indicate the DSC watch keeping receiver is on and operating.
 - The POWER lamp blinks in the data terminal.
 - If a distress or urgent DSC message is received, the equipment automatically turns on and sounds an alarm.
- Turn off both the AC and DC breakers if turning off the power at an external NBD-2150 AC/DC Power supply.

4.2.3 Communicating in radiotelephone mode

Use the handset to communicate in radiotelephone mode.

■ Procedure ■

1. When operating on a controller without access rights (OCC is displayed), press the jog dial to obtain the access rights.

Unless the controller with access rights is being used, the access rights are acquired and the OCC display on the screen disappears.

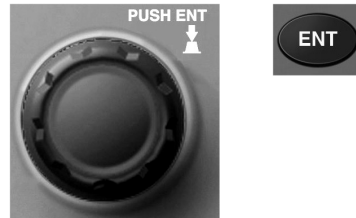

2. Press the **TEL** key.

- The communication mode is set to TEL and the previous frequency (or the default frequency at just after turning on) is set.
- Pressing the **TEL** key again turns the power to the PA on and off.
- If the power to the PA is on, **ON** is displayed as shown at right.

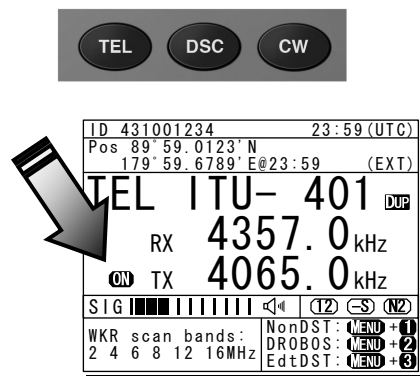

3. Set the frequency for making calls in radiotelephone mode.

- Note**
- When setting a frequency, the screen becomes operating display as shown at right.
 - The frequency is set on the receiving status in the status display or the operating display. For details, see "4.3.1 Setting the communication frequencies" and "4.3.2 Setting the communication channels".
 - See the frequency for making calls in the appendix "11.4 ITU channel list (TEL/CW/TLX)".

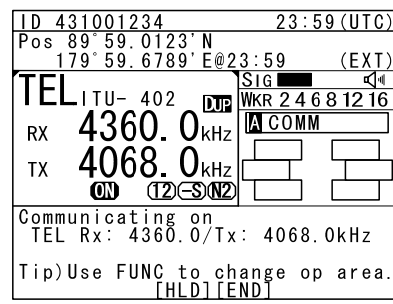

4. Adjust the volume of the loudspeaker by turning the volume control.



5. Turn the RF GAIN control to an appropriate reception level.



6. Press the **ANT TUNE** key to tune the antenna.

- Note**
- **T** blinks if the transmission frequency is not tuned.
 - Even if **T** is not displayed, tune the antenna before making a call.
 - **T** lights during tuning. It goes out after tuning.

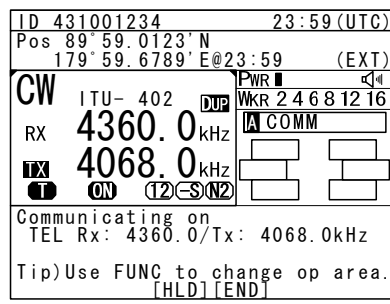

7. Lift the handset from the cradle.

8. Press the PTT key to talk.

The **TX** and **ON** marks appear on the screen to show the equipment is transmitting. Releasing the PTT key returns it to receiving.

- Note** Pressing the PTT key turns on the power to the PA automatically.

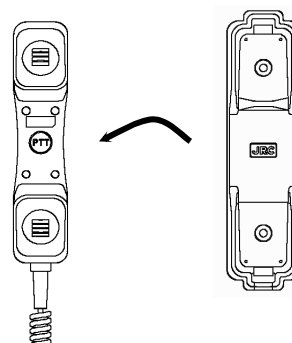

9. When finished communicating, return the handset to the cradle.

■ Making a radiotelephone call ■

1. Set a frequency the station to be called is monitoring.
2. Lift the handset from the cradle.
3. Press the PTT key, check that **TX** and **ON** are displayed and make a call as described below.
 - Say the name of the station being called ... Repeat 3 times.
 - Say "This is..."
 - Say own ship name ... Repeat 3 times.
 - If necessary, indicate your working frequency.
 - "over"
4. Release the PTT key to listen.
5. Start communicating according to the response. When changing frequencies, make sure that no other stations are using the indicated working channel.

- Note**
- When transmitting from your own station, always press the PTT key while talking.
 - On a simplex channel, always say "over" just before releasing the PTT key.
 - Always say "out" when terminating communications.

4.2.4 Communicating in CW mode

Use a CW keyer to communicate in CW mode.

■ Procedure ■

1. When operating on a controller without access rights (OCC is displayed), press the jog dial to obtain the access rights.

Unless the controller with access rights is being used, the access rights are acquired and the OCC display on the screen disappears.

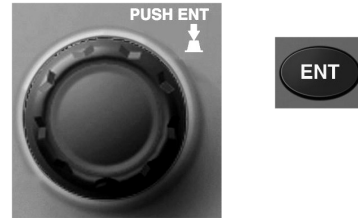

2. Press the **CW** key.

- The communication mode is set to CW and the previous frequency (or the default frequency at just after turning on) is set.
- Pressing the **CW** key again turns the power to the PA on and off.
- If the power to the PA is on, **ON** is displayed as shown at right.

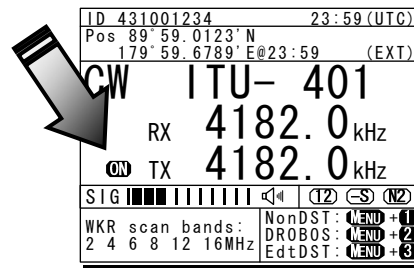

3. Set the frequency for making calls in CW mode.

Note

- When setting a frequency, the screen becomes operating display as shown at right.
- The frequency is set on the receiving status in the status display. For details, see "4.3.1 Setting the communication frequencies" and "4.3.2 Setting the communication channels".
- See the frequency for making calls in the appendix "11.4 ITU channel list (TEL/CW/TLX)".

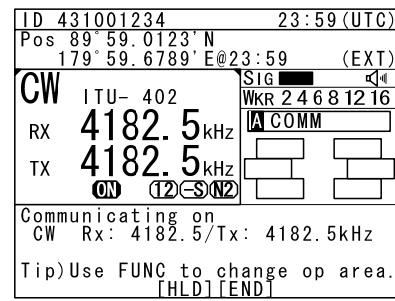

4. Adjust the volume of the loudspeaker by turning the volume control.



5. Turn the RF GAIN control to an appropriate reception level.



6. Press the **ANT TUNE** key to tune the antenna.

Note

- **T** blinks if the transmission frequency is not tuned.
- Even if **T** is not displayed, tune the antenna before making a call.
- **T** lights during tuning. It goes out after tuning.

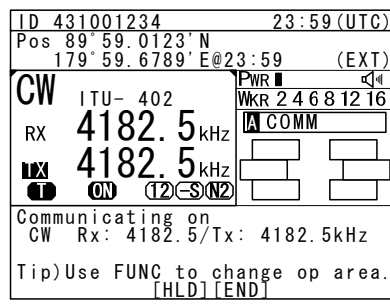

7. Communicate in CW mode using the CW keyer connected to the KEY jack on the controller as shown in the figure to the right.

The **TX** and **ON** marks appear on the screen to show the equipment is transmitting.

Note

- After keying on, turns on the PA power automatically.
- For the sidetone setting, see "5.3.2 Sound settings".



4.2.5 Receiving AM broadcasts

It is possible to listen to the radio in AM mode.

■ Procedure ■

1. When operating on a controller without access rights (OCC is displayed), press the jog dial to obtain the access rights.

Unless the controller with access rights is being used, the access rights are acquired and the OCC display on the screen disappears.

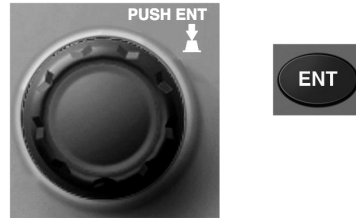

2. Press the **MENU** key, and through hierarchical menus, select 5. Radio operation.

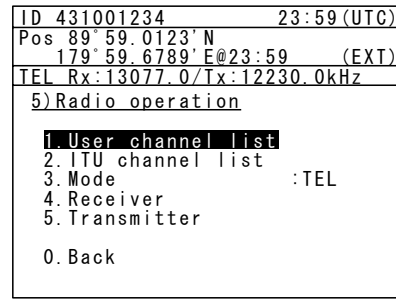

3. Move the cursor to 3. Mode, and press ENT.

Move the cursor to the right as shown in the figure at right to select a communication mode.

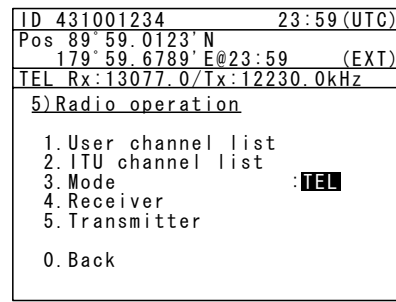

4. Turn the jog dial to select AM, and press ENT.

The communication mode is set to AM and the previous frequency (or the default frequency at just after turning on) is set.

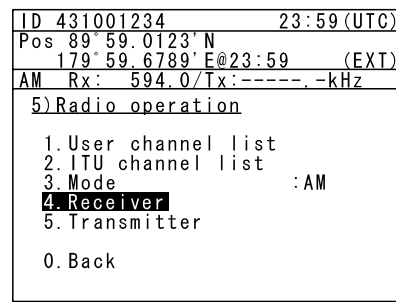

5. Press the **MENU** key twice to return to the status display and if required, input an AM broadcast frequency using the numeric keys.

Then press ENT to receive the broadcast.

Note

- Adjust the reception level and volume by turning the VOL and RF GAIN knobs according to the reception conditions.
- The AM mode is for reception only so a transmission frequency is not shown. Additionally, if AM is selected during blinking "T" (ATU does not tuned), the condition remains even after changing to the AM mode.



4.2.6 Communicating in telex mode (TLX)

When communicating in the telex mode, the data terminal is used. In the telex communication, the ARQ (Automatic Repeat reQuest) mode and FEC (Forward Error Correction) mode are available to communicate between two stations and to broadcast respectively. Additionally in the FEC mode, there are two modes of the CFEC (Collective Forward Error Correction) mode for unspecified receivers and SFEC (Selective Forward Error Correction) mode for specified receivers, which are selectable according to the purpose.

Attention

After starting the telex communication, always use the data terminal until to stop it even though the controller can terminate that communication with END option forcibly.

4.2.6.1 ARQ mode operation

To start the ARQ communication, make a call of the station by inputting the SELCAL number (4 digits for the coast station, 5 digits for the ship station or 9 digits) and the work frequency. After initiating the call, when receiving the response from the called station and the communication channel is established, the ARQ communication will be available.

■ Procedure ■

1. If displaying the message of "Press Enter key to get the access right in the NBDP mode..." on the data terminal, press Enter key on the keyboard.

The operation of the data terminal becomes possible in the telex mode, except when the controller is used.

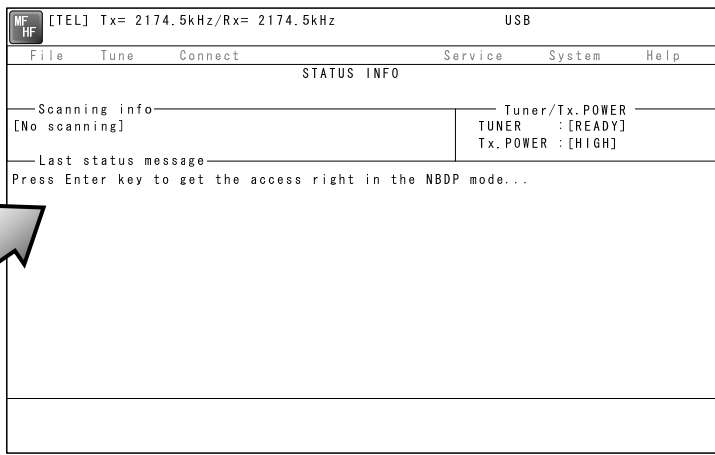
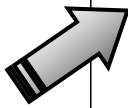

2. On the main menu and the dropdown menu, select Connect → ARQ with Enter key.

- The registered station list is displayed.
- When selecting [Manual] on this station list, the ID and frequency or ITU channel can be input manually.

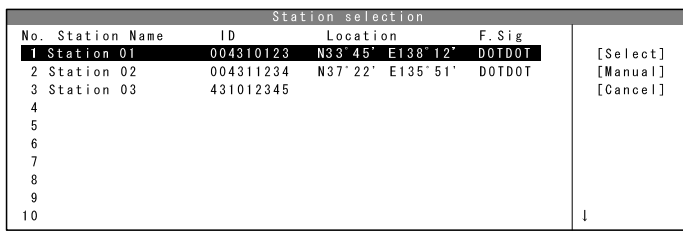

Operation

3. Select the station to be called with the cursor, and press Enter key.

- The frequency list of the selected radio station is displayed.
- If the position of the station is registered, the MUF (maximum usable frequency) is displayed in the lowest line as a reference to select the frequency. Also, the MUF can be calculated by the menu of Service → MUF calculation.

Frequency list						
Name : [Station 01]		ID : [004310123]		Loc : [N33°45' E138°12']		
No.	Tx.F	Rx.F	No.	Tx.F	Rx.F	
1	4202.5	4202.5	11	22354.5	22354.5	[Set]
2	4205.0	4205.0	12	25193.0	25193.0	[Print]
3	6300.5	6300.5	13	25208.0	25208.0	[Cancel]
4	6303.0	6303.5	14			
5	8396.5	8396.5	15			
6	8399.0	8399.0	16			
7	12560.0	12560.0	17			
8	16785.0	16785.0	18			
9	18893.0	18893.0	19			
10	22352.0	22352.0	20			
MUF: 9MHz, Range: 2537Miles, Sunspot: 14						

4. Select the work frequency with the cursor, and press Enter key.

- The selected frequency is set and the antenna is tuned to the frequency.
- The message as shown at right is displayed to confirm that the channel is busy.

Confirmation	
Is the frequency free now?	
Yes	No

5. Select Yes and press Enter key to start the call at the selected frequency.

Calling of the station is started with the ARQ mode.

MF HF [TLX] Tx= 2174.5kHz/Rx= 2174.5kHz		USB
File	Tune	Connect
STATUS INFO		
ARQ	Calling	Send
Phasing		
Scanning info	Tuner/Tx.POWER	
[No scanning]	TUNER : [READY]	
	Tx. POWER : [HIGH]	
Last status message		
ARQ: 20 AUG, 2010 17:15		
Station:[Station 01] ID:[004310123] Loc:[N33°45'E138°12']		
*Waiting for transmitter ready		
*Received TX-READY signal		
F10 Stop		

6. When receiving the periodic reply from the called station and the communication channel is established, the ARQ communication will be available.

- The screen as shown at right is displayed.
- If receiving no response within one minute, the calling will be ceased automatically. In this case, the same call is inhibited for about one minute.

MF HF [TLX] Tx= 2174.5kHz/Rx= 2174.5kHz		USB
Station ID:[004310123]		
TELEX Terminal Window		
ARQ	Calling	Send
Message start...		
F2 WRU F3 Hereis F4 TMS F5 Over F8 F.Send F10 Stop		

7. The characters typed with the keyboard can be transmitted in sequence. And all of the characters displayed on the screen are printed out on the printer.

- In the ARQ mode, it is possible to alternate the information sending station (ISS) and the information receiving station (IRS).
- While “Send” is displayed on the segment that shows the operation status, the own station is ISS and able to send a message.
- After sending a message, send “+?” to give the sending right to the IRS.
- While the condition is IRS, the sending right can be acquired by pressing F5 Over without waiting for “+?” from ISS. Further, refer to the chapter 2 for other function keys.
- Besides alphabets and the figures, following signs can be input from the keyboard.
- ? : () . , ' = / +

Note: As the alphabets, capital letters only are available.

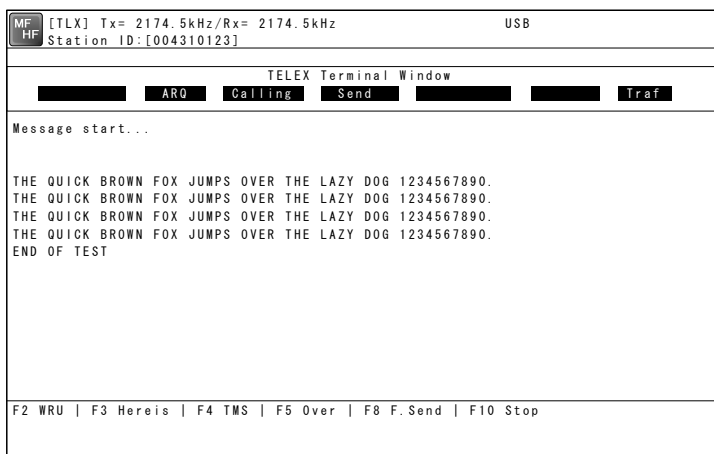

8. To finish the communication, press F10 Stop key.

- When receiving the reply to the request for the end of communication, returns to the standby condition.
- F10 Stop is always available while communicating regardless of ISS/ IRS. Note that if pressing the F10 key during IRS condition, the station becomes ISS temporarily to send the end of communication.
- When pressing the F10 Stop key during sending a message, the sending message buffer is cleared at once and initiates the end of communication process.
- When POLL is set at IRS and the end of communication is requested by ISS, the IRS can acquire the sending right without ending the communication.

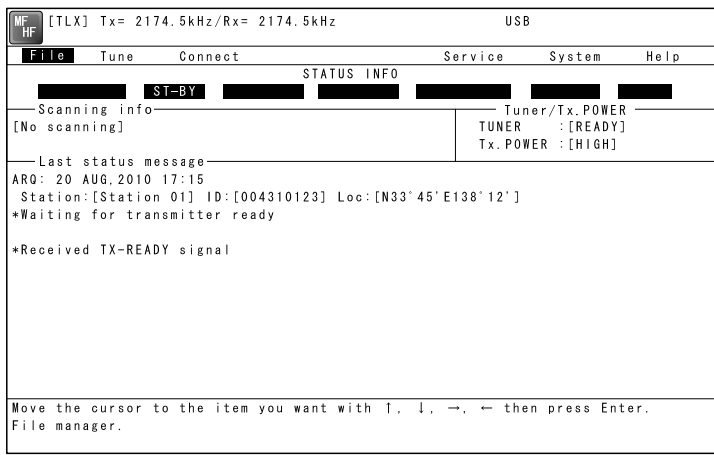

Note

When receiving the ARQ call from another station during standby condition, the operation under the communication is basically similar.

4.2.6.2 CFEC mode operation

(1) Sending with CFEC

Messages can be sent as a broadcast on the selected work frequency using the CFEC mode.

■ Procedure ■

1. If displaying the message of "Press Enter key to get the access right in the NBDP mode..." on the data terminal, press Enter key on the keyboard.

The operation of the data terminal becomes possible in the telex mode, except when the controller is used.

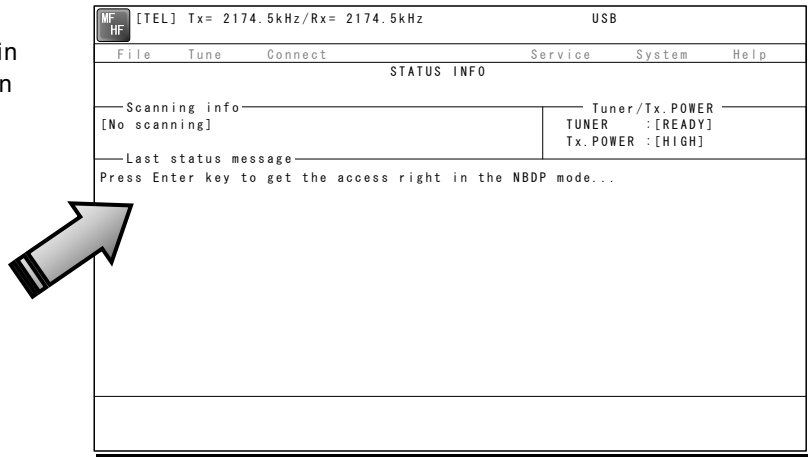

2. On the main menu and the dropdown menu, select Connect → CFEC with Enter key.

- Input the frequency or ITU channel on the screen as shown at right.
- To input the frequency, press Enter key to move the cursor to the right.
- To input the ITU channel, select the ITU channel button and press Enter key to display the specific screen as shown at right. Then press Enter key to move the cursor to the right.

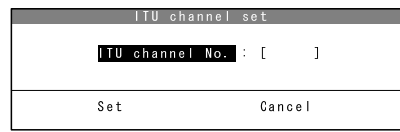
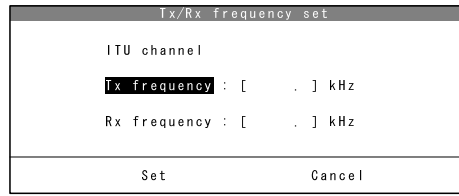

3. Input the work frequency or ITU channel, and press Enter key.

- The selected frequency is set and the antenna is tuned to the frequency.
- The message as shown at right is displayed to confirm that the channel is busy.

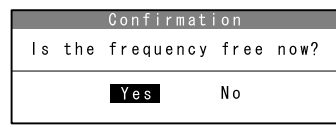

- Select Yes and press Enter key to start the call at the selected frequency.

Sending the phasing signal is started with the CFEC mode.

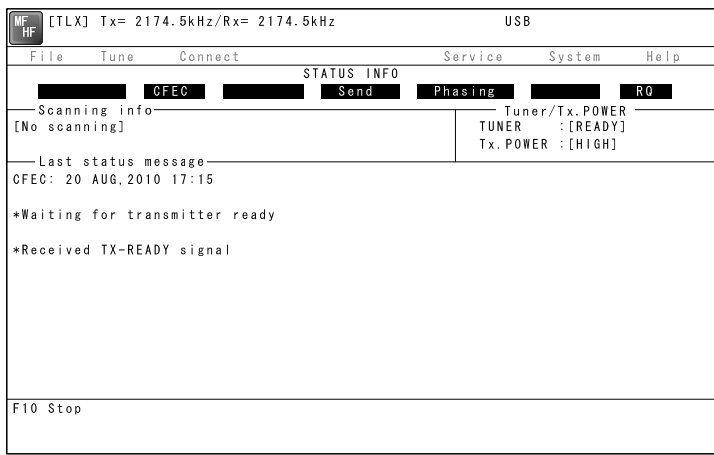

- After sending the phasing signal for about 15 seconds, the message sending using the CFEC mode will be available.

The screen as shown at right is displayed.

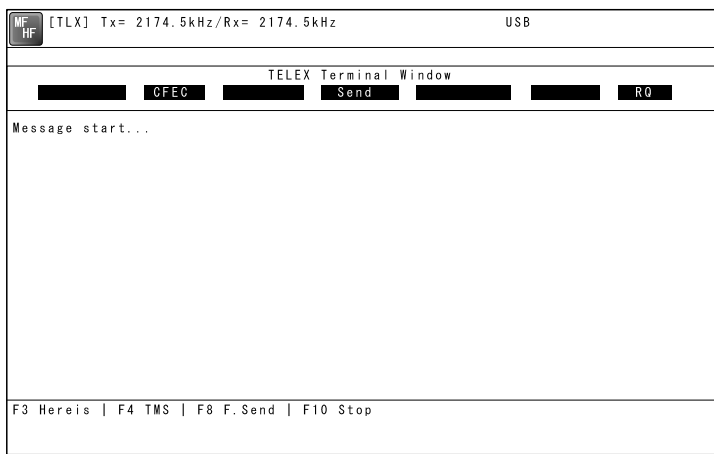

- The characters typed with the keyboard can be transmitted in sequence. And all of the characters displayed on the screen are printed out on the printer.

- Refer to the chapter 2 for the function key.
- Besides alphabets and the figures, following signs can be input from the keyboard.
- ? : () . , ' = / +

Note: Only the capital letter can be used for the alphabet.

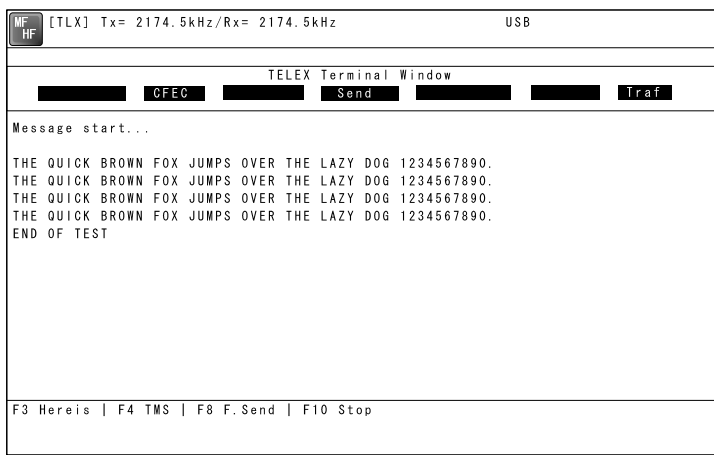

Operation

7. To finish the communication, press F10 Stop key.

- After sending the end of communication for about five seconds, returns to the standby condition.
- When pressing the F10 Stop key during sending a message, the sending message buffer is cleared at once and initiates the end of communication process.

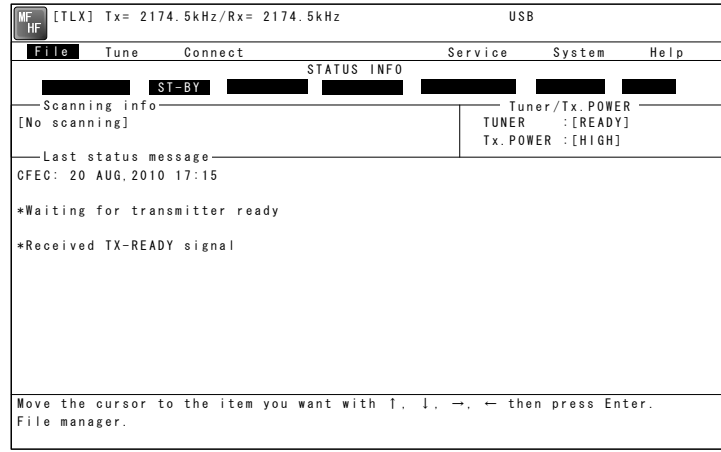

(2) Receiving CFEC broadcasting

CFEC broadcasting messages can be received on the selected work frequency.

■ Procedure ■

1. If displaying the message of "Press Enter key to get the access right in the NBDP mode..." on the data terminal, press Enter key on the keyboard.

The operation of the data terminal becomes possible in the telex mode, except when the controller is used.

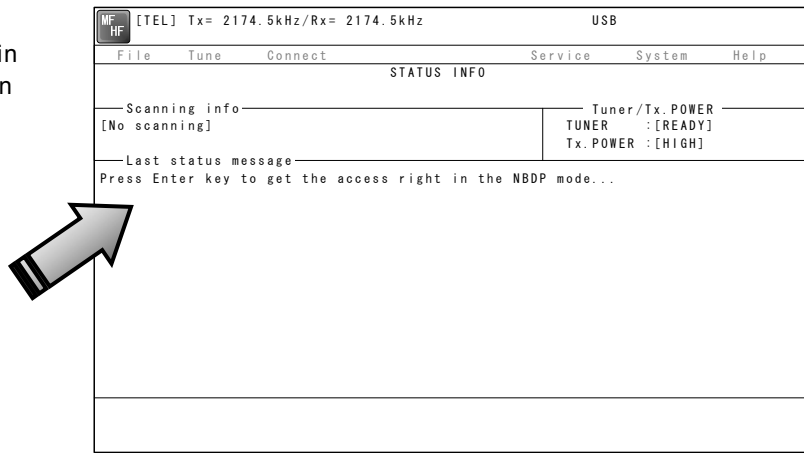

2. On the main menu and the dropdown menu, select Tune → Tx/Rx frequency set with Enter key.

- The screen as shown at right is displayed.
- To input the frequency, press Enter key to move the cursor to the right.
- To select the frequency from the frequency list, select Tune → Frequency list and open the frequency list of either one of radio stations.

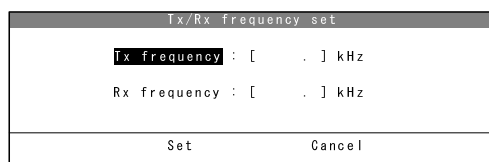

3. Input the receiving frequency of the CFEC broadcasting, and press Enter key.

The antenna is tuned to the frequency and the message as shown at right is displayed.

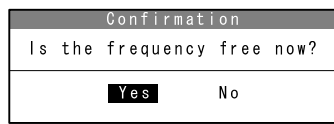

Note

The transmitting frequency is set simultaneously by the above procedure, but in this case the frequency is meaningless. So selecting Yes and pressing Enter would be right.

4. When receiving the phasing signal, initiates the CFEC receiving condition.

The segment of the operation status shows receiving the phasing signal.

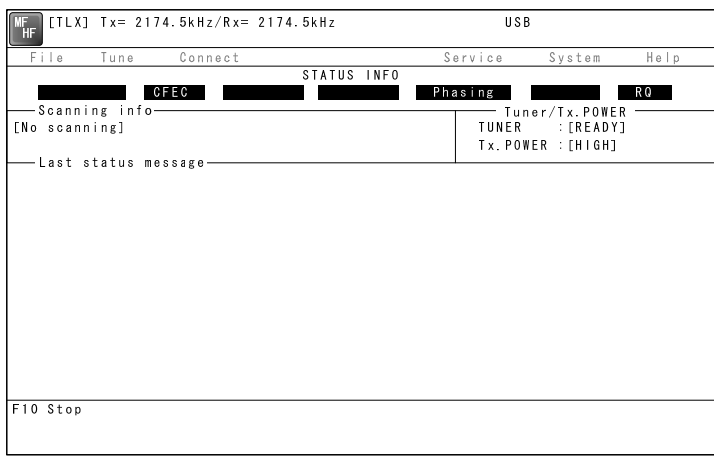

5. When receiving the message start code (the carriage return and the line feed), initiates the message reception.

- All of the characters displayed on the screen are printed out on the printer.
- If detected the character error, the error correction with the time-diversity is performed, but upon the channel quality, the error would be beyond the capacity and the error code (asterisk) would be displayed.
- To finish the reception, press F10 Stop key. Note that, if receiving the phasing signal continuously, the CFEC receiving would be restarted just after finishing.

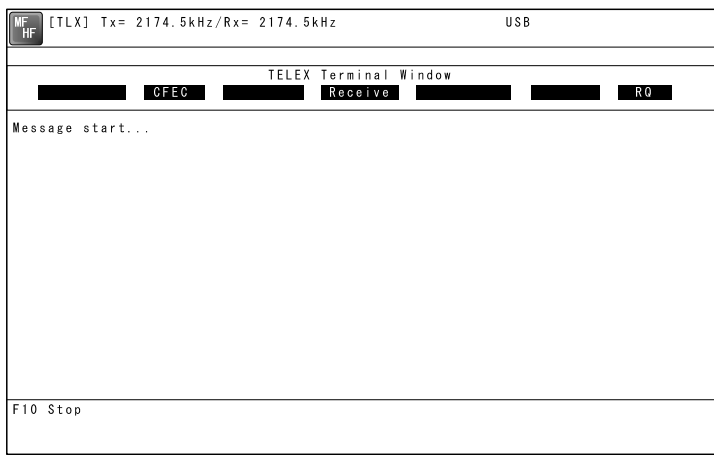

Note

- If the "Collective FEC receiving" setting (System → NBDP setup) is off, neither the CFEC broadcasting nor the SFEC broadcasting are received.
- Receiving the CFEC broadcasting can be started even if on the way of the message because the phasing signal would be interrupted for every 100 characters. Afterwards, the reception of the message starts as soon as detecting the message start code (the carriage return and the line feed).

4.2.6.3 SFEC mode operation

Messages can be sent to the specific stations as a broadcast on the selected work frequency using the SFEC mode. Additionally, regarding the SFEC reception, refer to the previous section because it is similar to the CFEC reception.

■ Procedure ■

1. If displaying the message of "Press Enter key to get the access right in the NBDP mode..." on the data terminal, press Enter key on the keyboard.

The operation of the data terminal becomes possible in the telex mode, except when the controller is used.

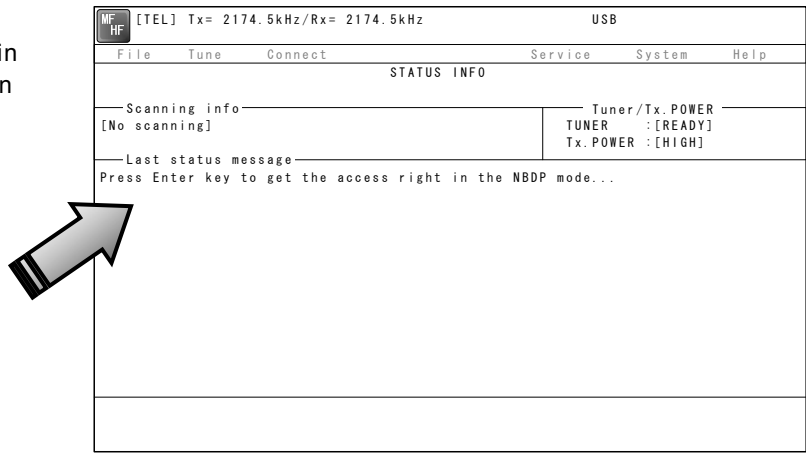

2. On the main menu and the dropdown menu, select Connect → SFEC with Enter key.

- The registered station list is displayed.
- When selecting [Manual] on this station list, the ID and frequency or ITU channel can be input manually.

Station selection				
No.	Station Name	ID	Location	F. Sig
1	Station 01	004310123	N33°45' E138°12'	DOTDOT
2	Station 02	004311234	N37°22' E135°51'	DOTDOT
3	Station 03	431012345		
4				
5				
6				
7				
8				
9				
10				

3. Select the station to be called with the cursor, and press Enter key.

- The frequency list of the selected radio station is displayed.
- If the position of the station is registered, the MUF (maximum usable frequency) is displayed in the lowest line as a reference to select the frequency. Also, the MUF can be calculated by the menu of Service → MUF calculation.

Frequency list					
Name : [Station 01] ID : [004310123] Loc : [N33°45' E138°12']					
No.	Tx.F	Rx.F	No.	Tx.F	Rx.F
1	4202.5	4202.5	11	22354.5	22354.5
2	4205.0	4205.0	12	25193.0	25193.0
3	6300.5	6300.5	13	25208.0	25208.0
4	6303.0	6303.5	14		
5	8396.5	8396.5	15		
6	8399.0	8399.0	16		
7	12560.0	12560.0	17		
8	16785.0	16785.0	18		
9	18893.0	18893.0	19		
10	22352.0	22352.0	20		

MUF: 9MHz, Range: 2537Miles, Sunspot: 14

4. Select the work frequency with the cursor, and press Enter key.

- The selected frequency is set and the antenna is tuned to the frequency.
- The message as shown at right is displayed to confirm that the channel is busy.

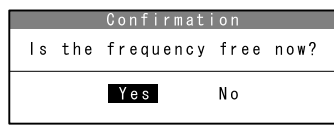

5. Select Yes and press Enter key to start the call at the selected frequency.

- The SFEC broadcasting is started.
- First, the phasing signal same with CFEC mode is sent.

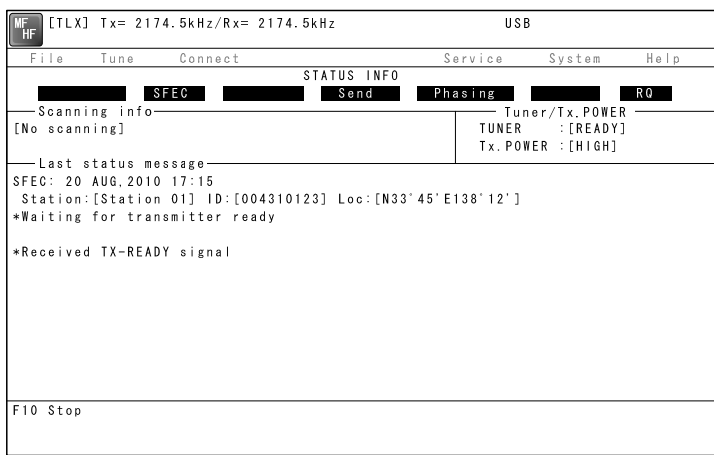

6. After sending the phasing signal followed by the SELCAL number, the message sending using the SFEC mode will be available.

The screen as shown at right is displayed.

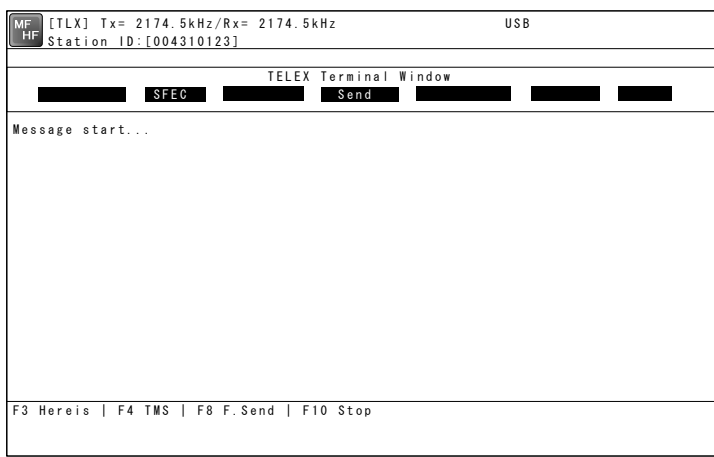

Note The following procedure is the same as the CFEC mode.

4.2.6.4 Editing telex messages

When communicating in the telex mode, the message file can be sent, which is prepared beforehand as follows.

■ Procedure ■

1. If displaying the message of "Press Enter key to get the access right in the NBDP mode..." on the data terminal, press Enter key on the keyboard.

The operation of the data terminal becomes possible in the telex mode, except when the controller is used.

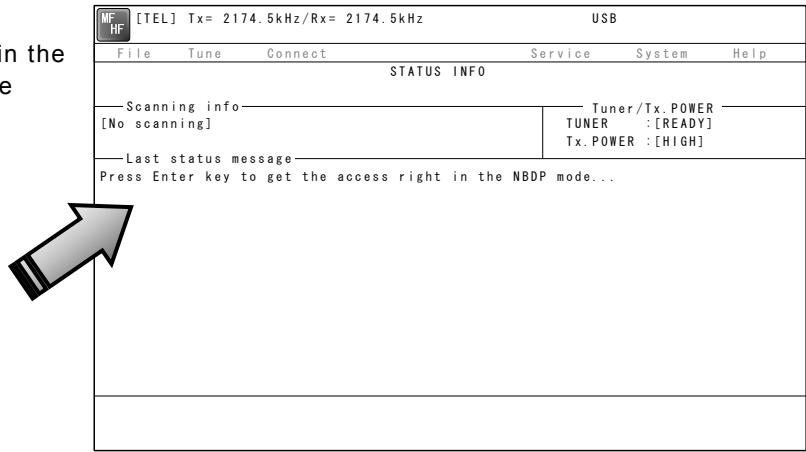

2. On the main menu and the dropdown menu, select File → Edit new file with Enter key.

- The editing screen is displayed as shown at right.
- To edit an existing file, select File → Edit existing file.

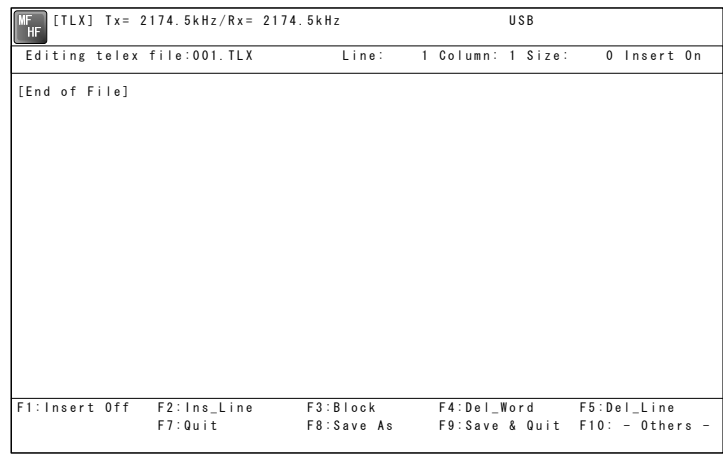

3. Make the message with the keyboard.

- Besides alphabets and the figures, following signs can be input from the keyboard.
- ? : () . , ' = / +
- Only the capital letter can be used for the alphabet.
- When the number of characters for each line becomes more than 70 or a specified number, line feed is automatically inserted.
- When pressing the Tab key, inserts the space of the number set by F2 Set tab is inserted.

4. Press F9 (Save & Quit) key when saving the message the file and finishing editing.

After closing the editing screen, returns to the regular screen.

Note - The function keys available for the edit screen and the content are as follows.

● Group 1

- F1 : Insert On/Off Sets the input condition to the insert mode by pressing it while Insert On is displayed. And sets the input condition to the overwrite mode by pressing it while Insert Off is displayed. Current conditions are indicated on the upper-right corner of the screen.
- F2 : Ins_Line Add a line to the line of the cursor position.
- F3 : Block Indicates the following block menu.
 - Top-marker of block: Specifies the cursor position for a starting point of the block.
 - Bottom-marker of block: Specifies the cursor position for a ending point of the block.
 - Remove markers: Releases the specification of the block.
 - Copy Block: Copies and pastes the character string specified in the block onto the cursor position.
 - Move block: Moves the character string specified in the block to the line position of the cursor.
 - Delete block: Deletes the character string specified in the block.
 - Go to the block: Moves the cursor to the starting point of the block.
- F4 : Del_Word Deletes the word at the cursor position.
- F5 : Del_Line Deletes the line at the cursor position.
- F6 : (N/A)
- F7 : Quit Finishes editing without saving the message file.
- F8 : Save As Saves the message file with the new name.
- F9 : Save & Quit Saves the message file by overwriting and finishes editing.
- F10 : - Others - Assigns the group 2 to the function keys.

● Group 2

- F1 : Max Column Specifies the column width of a line.
- F2 : Set Tab Specifies the tab position on the edit screen.
- F3 : Undo_Char Insert the character erased at the end to the cursor position.
- F4 : Undo_Word Insert the word erased with F4 Del_Word to the cursor position.
- F5 : Undo_Line Insert the line erased with F5 Del_Line to the line of the cursor position.
- F6 : Merge File Selects an existing message file to merge to the message file under the edit.
- F7 : Find Searches a specified character string.
- F8 : Print_out Prints the message file under the edit.
- F9 : Find/Replace Searches a specified character string and replaces it with another character string.
- F10 : - Others - Assigns the group 1 to the function keys.

Operation

- Besides editing messages mentioned above, the following items in the file menu concerning to the message files are available.
 - Rename file Changes the name of the file saved in flash ROM(C:) or USB memory (A:).
 - Delete file Deletes the file saved in the flash ROM (C:) or the USB memory (A:).
 - Copy file Copies a file (32kB or less) saved in the flash ROM (C:) or the USB memory (A:) to another folder or drive.
 - Initialize USB Formats the attached USB memory (A:).
 - Remove USB..... Unmounts the USB drive (A:) to remove the attached USB memory.

- The maximum size of the message file is 8192 bytes.

- The maximum number of the message files saved in the TEXT folder is one hundred.

- When naming or renaming a filename, the space character is unavailable for the character string.

4.3 Setting the radio

This section describes how to set the communication frequencies and how to use the receiver and transceiver functions.

4.3.1 Setting the communication frequencies

Use the free frequency input mode to input the communication frequencies directly.

■ Procedure ■

1. In the status display, use the numeric keypad to input the frequency.

Note

- When 1 is input using the numeric keypad, it appears on the far right as shown in the screen on the right.
- In the user/ITU channel input mode, press the **CH** key once or twice to hide the channel display.

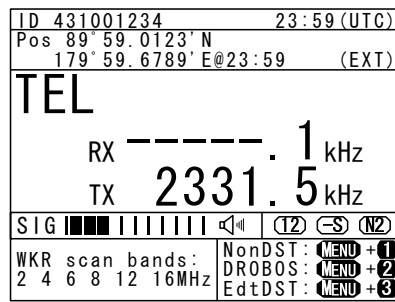

2. Input numbers to the 0.1 kHz place and press ENT.

The transmission frequency input mode opens as shown in the screen at right.

Note

- For a simplex frequency, press ENT to automatically input the same frequency as the receiving frequency to complete communication frequency settings.

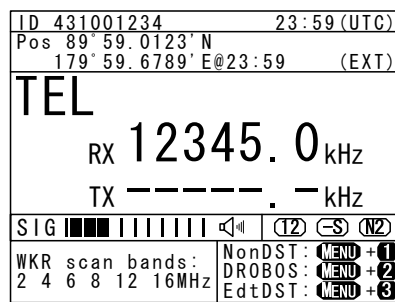

3. Input the transmission frequency in the same way as the reception frequency.

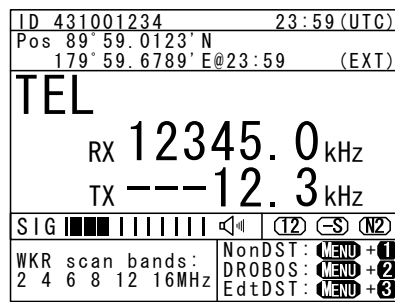

4. Input numbers to the 0.1 kHz place and press ENT.

The communication frequency settings are complete and the screen shows the operating display.

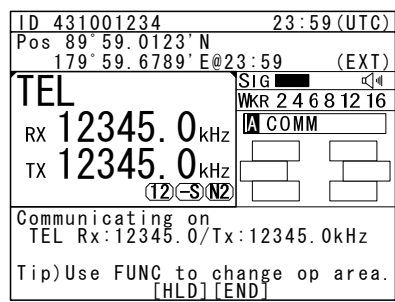

Note

- Turn the jog dial in the status display to change the reception frequency on the 0.1 kHz scale. For simplex frequencies, the transmission frequency is changed at the same time.
- The above operation is also available on the transceiver setting screen of the operating display.
- The above operation is unavailable in the telex mode. The telex frequency is set with the menu of the data terminal, as Tune → Tx/Rx frequency set.

4.3.2 Setting the communication channels

Besides the free frequencies described previously, ITU channel mode and user channel modes can also be set. The ITU channel mode is mode for using channels based on the international standard and is built-in to the equipment. The user channel mode is the mode for using channels on pre-registered frequencies. These modes can be used according to the operations.

(1) Selecting a frequency and channel input mode

■ Procedure ■

1. Set the screen of the status display or the operating display.

The operating display at right shows free frequency mode.

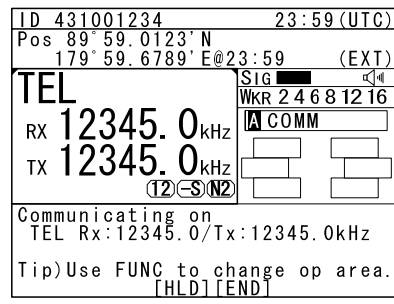

2. Press the **CH** key.

As shown below, each time the **CH** key is pressed the mode changes in order from the free frequency mode, ITU channel mode, to the user channel mode.

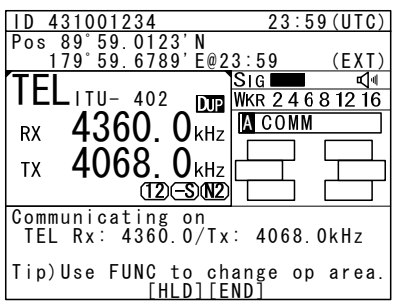
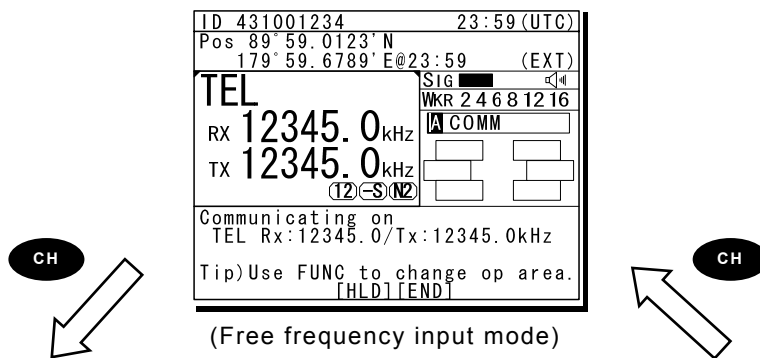

(ITU channel mode)

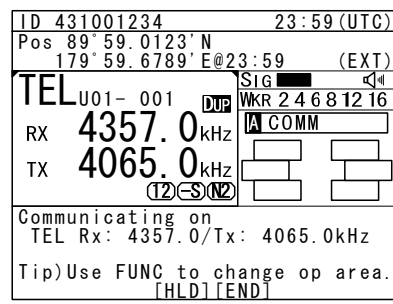
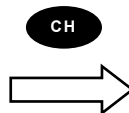

(User channel mode)

Note

- If changed to the ITU channel mode, the communication mode of the free frequency input mode and the previous (or lowest) ITU channel number are applied.
- The above operation is unavailable in the telex mode.
- If the communication mode is changed by pressing the **TEL**, **DSC**, or **CW** keys, the free frequency input mode is set.

(2) Setting the ITU channels

■ Procedure ■

1. After setting the TEL, DSC or CW modes, press the **CH** key to set the display to the ITU channel mode.

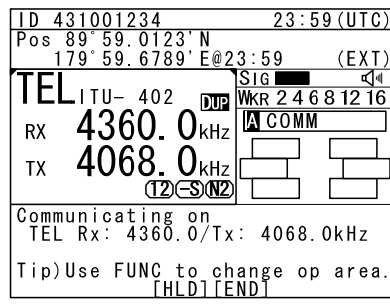

2. Input the channel by using the numeric keypad.

Note

When 4 is input using the numeric keypad, it appears on the far right as shown in the screen on the right.

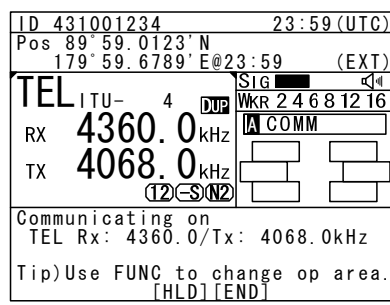

3. Input the rest of the digits and press ENT.

The input ITU channel frequency is displayed and the settings are complete.

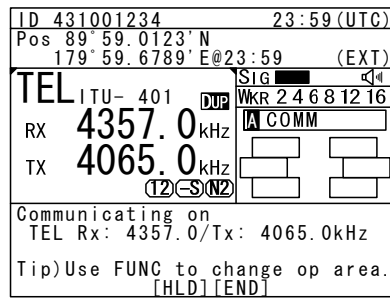

Note

- See the appendix "11.4 ITU channel list (TEL/CW/TLX)" for a list of pre-installed ITU channels and their frequencies.
- Besides doing settings with the numeric keypad, settings can also be done with the jog dial.
- For DSC mode, normally perform the above procedure to receive the routine message. Furthermore, when sending a DSC message, the calling frequency is set via the menu automatically and the above procedure is not needed.
- The above operation is unavailable in the telex mode. The ITU channel in the telex mode is set with the controller menu 5.2 ITU channel list, or the data terminal menu operation, as Tune → ITU channel set.

(3) Setting user channels

A total of 20 groups with 20 channels set to each group (i.e. 400 channels) can be registered on the equipment. This section explains how to set channels that are already registered.

■ Procedure ■

1. Use the **CH** key to set the display to the user channel mode status display.

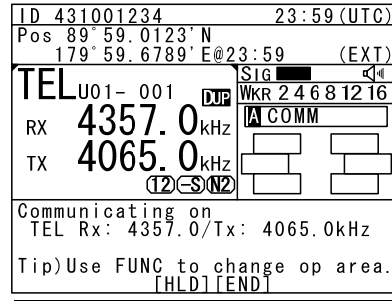

2. Pressing ENT causes the channel group number to blink so a channel group can be input.

Use the numeric keypad or jog dial to input the number of a registered group.

Note When 2 is input using the numeric keypad, it appears on the far right as shown in the screen on the right.

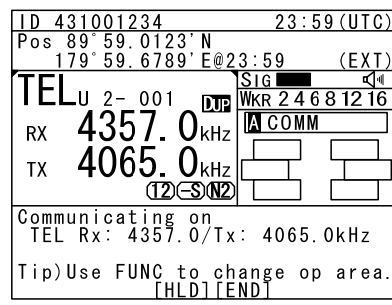

3. After inputting a group number, pressing ENT causes the channel number to blink so a user channel can be input.

Use the numeric keypad or jog dial to input the number of a registered channel.

Note When 3 is input using the numeric keypad, it appears on the far right as shown in the screen on the right.

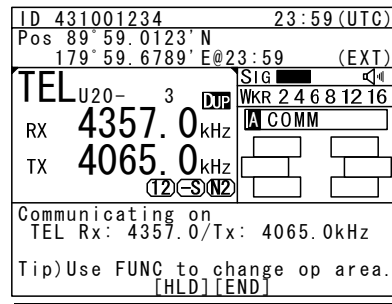

4. Input the rest of the digits and press ENT.

- The input user channel frequency is displayed and the settings are complete.
- The group name is displayed for 3 seconds after the settings are done.

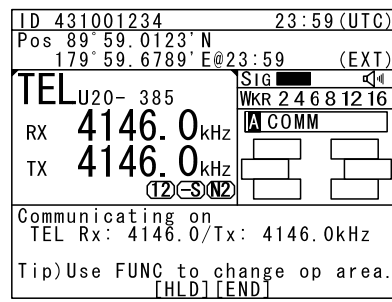

Note

- Channels can be set directly in the status display or the operating display by using the numeric keypad or the jog dial without setting a channel group. After inputting with the numeric keypad, press ENT.
- See "5.4 Registering user channels" for how to register frequencies to user channels.
- The user channel of the telex mode is set with the menu of the data terminal, as Tune → Frequency list.

(4) Using channel lists

Besides the procedure above, user channels (except the telex mode) and ITU channels can also be set from the channel lists (5.1 User channel list or 5.2 ITU channel list). This section explains how to set channels that are already registered from the user channel list.

■ Procedure ■

1. Press the **MENU** key, and through hierarchical menus, select 5. Radio operation.

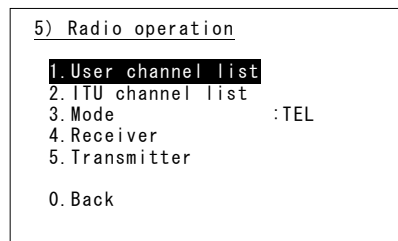

2. Select 1. User channel list and press ENT.

The user channel list index (group list) as shown at right is displayed.

5.1)User channel list (index)		
No	CH group name	Type
01	JRC Tokyo	TEL
02	Pacific ABC	CW
03		
04		
05		
06		
07		
▼08		

3. Select the intended channel group and press ENT.

The user channel list as shown at right is displayed.

5.1)User channel list (table)			
Name: JRC Tokyo			
Type: TEL			
CHNo	Rx[kHz]	Tx[kHz]	Mode
001	4357.0	4065.0	TEL
002	4360.0	4068.0	TEL
003	4363.0	4071.0	TEL
004	4366.0	4074.0	TEL
005	4369.0	4077.0	TEL
▼006	4372.0	4080.0	TEL

4. Select the channel to set and press ENT.

The user channel settings are complete, the status display is displayed.

ID 431001234 23:59 (UTC)
 Pos 89° 59.0123' N
 179° 59.6789' E@23:59 (EXT)
TEL U01- 001 **DUP** WKR 2 4 6 8 12 16
 RX 4357.0 kHz **COMM**
 TX 4065.0 kHz
 (12) (S) (02)
 Communicating on
 TEL Rx: 4357.0/Tx: 4065.0kHz
 Tip) Use FUNC to change op area.
 [HLD] [END]

4.3.3 Setting the automatic gain control (AGC)

■ Procedure ■

1. Press the **MENU** key, and through hierarchical menus, select 5.4 Receiver.

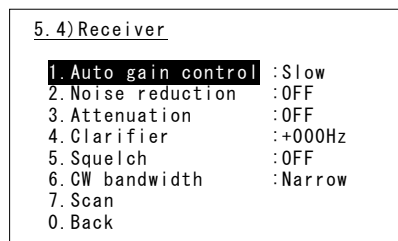

2. Select 1. Auto gain control and press ENT, when the cursor moves to the right use the jog dial to select Slow, Fast, or OFF.

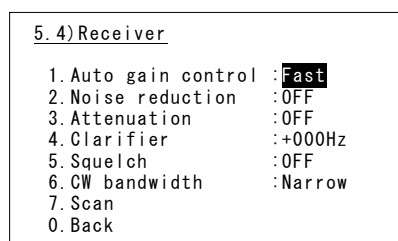

After selecting and pressing ENT, the settings are complete.

Note The same settings can be done by pressing and holding the **FUNC** key and the **5AGC** key at the same time.

4.3.4 Setting the noise reduction (NR)

■ Procedure ■

1. Press the **MENU** key, and through hierarchical menus, after 5.4 Receiver appears, move the cursor to 2. Noise reduction.

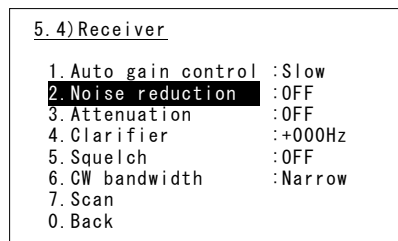

2. Press ENT to move the cursor to the right, then use the jog dial to select NR1, NR2, BC, or OFF.

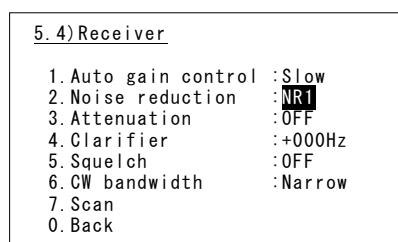

After selecting and pressing ENT, the settings are complete.

Note

- The various settings are shown below.
 - NR1 : Noise reduction (low)
 - NR2 : Noise reduction (high)
 - BC : Beat canceller
- The same settings can be done by pressing and holding the **FUNC** key and the **3NR** key at the same time.
- This function is invalid in DSC mode or telex mode. Moreover, the beat canceller becomes invalid in CW mode.

4.3.5 Setting the attenuation (ATT)

■ Procedure ■

1. Press the **MENU** key, and through hierarchical menus, after 5.4 Receiver appears, move the cursor to 3. Attenuation.

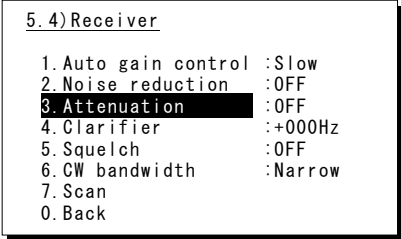

2. Press ENT to move the cursor to the right, then use the jog dial to select 6dB, 12dB, 18dB, or OFF.

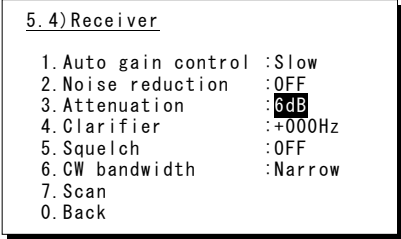

After selecting and pressing ENT, the settings are complete.

Note The same settings can be done by pressing and holding the **FUNC** key and the **4ATT** key at the same time.

4.3.6 Setting the clarifier

■ Procedure ■

1. Press the **MENU** key, and through hierarchical menus, after 5.4 Receiver appears, move the cursor to 4. Clarifier.

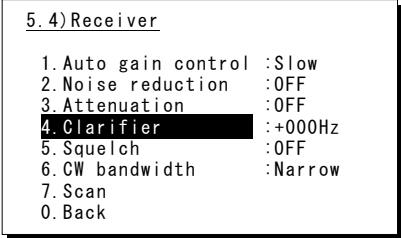

2. Press ENT to move the cursor to the right, then use the jog dial or numeric keypad to select a value in the range of -200 to +200 Hz.

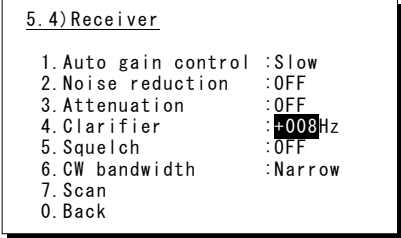

After inputting and pressing ENT, the settings are complete.

Note

- When using the numeric keypad, input "+" with the **1CLAR** key and "-" with the **2SCAN** key.
- Pressing and holding the **FUNC** key and the **1CLAR** key at the same time opens a popup screen. The same settings can be done here.
- This function is invalid in the DSC mode or the telex mode.

4.3.7 Setting the squelch level

■ Procedure ■

1. Press the **MENU** key, and through hierarchical menus, after 5.4 Receiver appears, move the cursor to 5. Squelch.

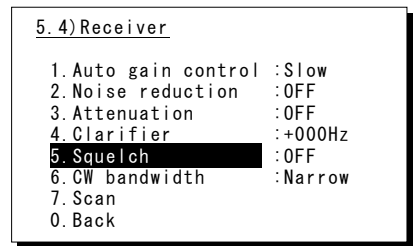

2. Press ENT to move the cursor to the right, then use the jog dial or numeric keypad to input a value in the range of 000 to 100.

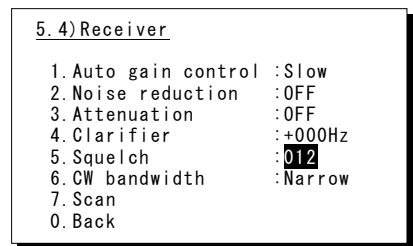

After inputting and pressing ENT, the settings are complete.

- Note**
- Setting the value to 000 automatically displays it as OFF.
 - This function is invalid in the DSC mode or the telex mode.

4.3.8 Setting the CW bandwidth

■ Procedure ■

1. Press the **MENU** key, and through hierarchical menus, after 5.4 Receiver appears, move the cursor to 6. CW bandwidth.

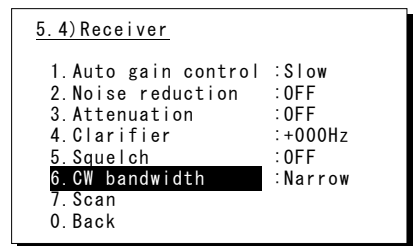

2. Press ENT to move the cursor to the right, then use the jog dial to select Wide or Narrow.

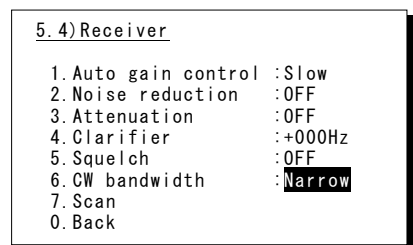

After inputting and pressing ENT, the settings are complete.

- Note**
- This function is enabled in CW mode only.

4.3.9 Scanning the Rx frequencies

(1) Scanning of channels in TEL/DSC/CW mode

The scanning of channels in the TEL/DSC/CW mode is started with the controller.

■ Procedure ■

1. Press the **MENU** key, and through hierarchical menus, after 5.4 Receiver appears, move the cursor to 7. Scan.

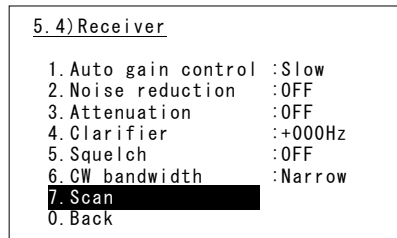

2. Press ENT to confirm the selection.

The group list as shown at right is displayed.

- Note**
- The previous scan can be restarted by pressing and holding the **FUNC** key and then pressing the **2SCAN** key on the status display.
 - If the user channel is not registered, scan cannot be done so the screen shown at right is not displayed.

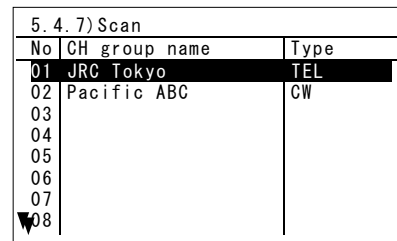

3. Select the channel group to scan with the cursor and press ENT.

The popup screen as shown at right is displayed.

- Note**
- If the popup screen shown at right is displayed during scanning, Stop appears instead of Execute.

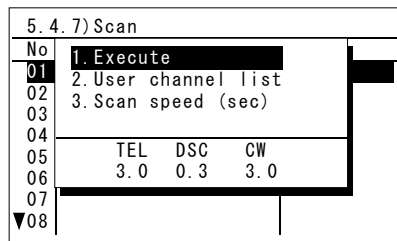

4. Select 1. Execute and press ENT, the screen at right is displayed and scanning starts.

- To check the registered channels in the channel group, select 2. User channel list and press ENT.
- To change the scanning speed, select 3. Scan speed (sec) and press ENT. The setting range is 0.3 to 9.9 seconds, the same as TEL/DSC/CW.

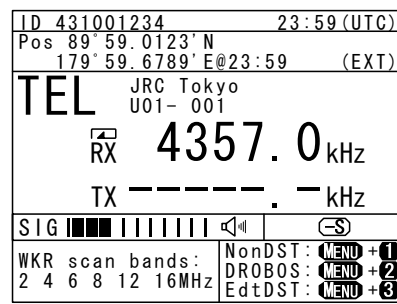

- Note**
- Scanning can be done regardless of the squelch being set to open or close. When pressing the PTT or keying the CW keyer, or when squelch is opened after closing condition, scanning stops momentarily and the icon starts blinking. In this case the scanning can be restarted by pressing ENT.
 - To stop scanning, press the **CANCEL** key.
 - When scanning to receive routine DSC calls, set the scan speed to 0.3 seconds within 6 channels.
Note: If too many channels are being scanned, it may not catch the reception.

(2) Scanning of channels in telex mode

The scanning of channels in the telex mode is started with the data terminal.

■ Procedure ■

1. If displaying the message of "Press Enter key to get the access right in the NBDP mode..." on the data terminal, press Enter key on the keyboard.

The operation of the data terminal becomes possible in the telex mode, except when the controller is used.

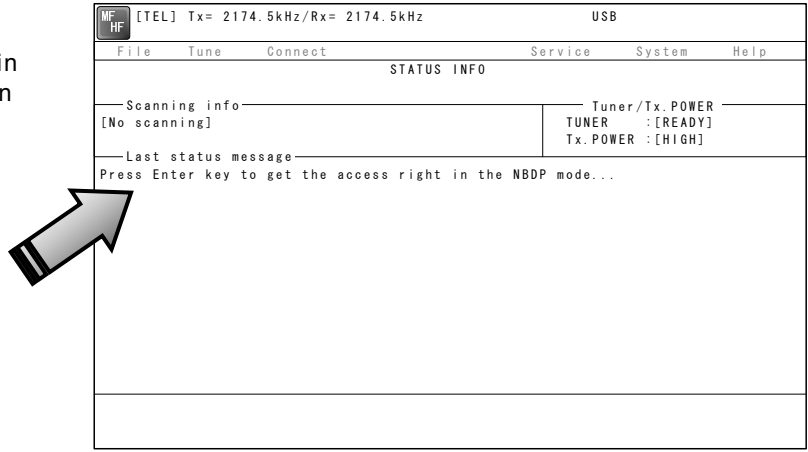

2. On the main menu and the dropdown menu, select Tune → Scanning start with Enter key.

The registered station list is displayed.

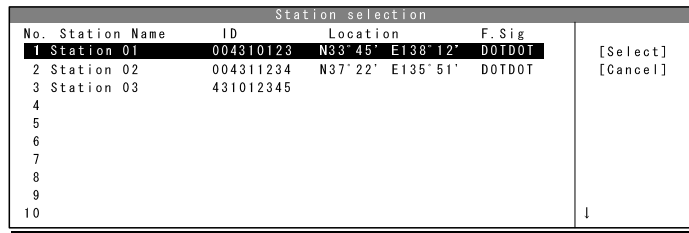

3. Select the radio station having the channel group to be scanned with the cursor, and press Enter key.

The antenna is tuned to the every frequency registered in the selected radio station. The screen at right is displayed while tuning the antenna.

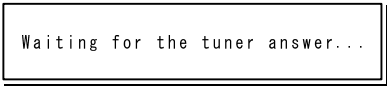

4. After completing the antenna tuning, scanning starts.

- The screen as shown at right is displayed while scanning.
- When receiving a call by the ARQ or FEC mode, scanning stops and the communication starts. After finishing the communication, scanning restarts automatically.
- The scanning speed can be changed with the menu on the regular screen, as System → Scan speed.
- When breaking the scanning, select Tune → Scanning stop.

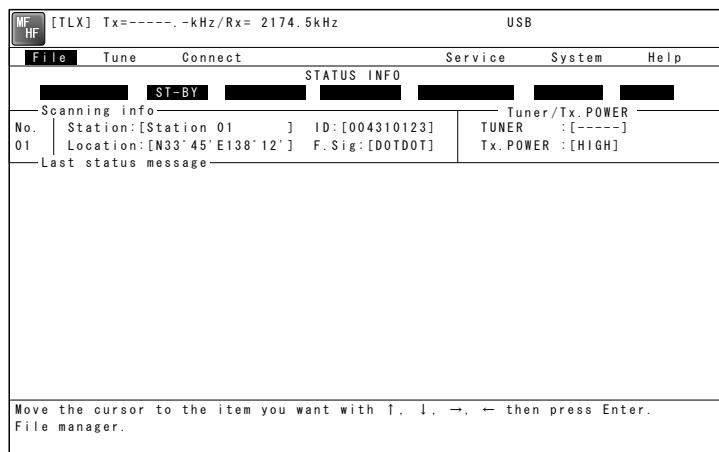

4.3.10 Reducing the Tx power

■ Procedure ■

1. Press the **MENU** key, and through hierarchical menus, select 5.5 Transmitter.

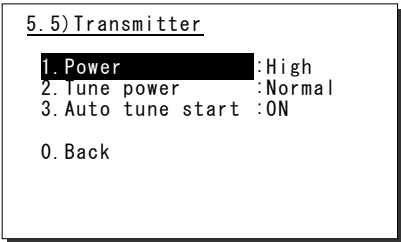

2. Select 1. Power and press ENT to move the cursor to the right, then use the jog dial to select Low.

After selecting and pressing ENT, the settings are complete.

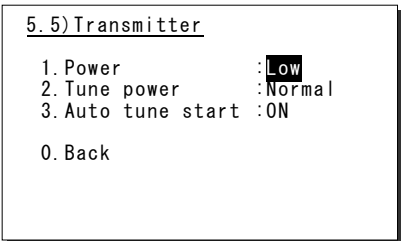

Note

- The same settings can be done by pressing and holding the **FUNC** key and the **9 PWR RDC** key at the same time.
- When the Tx power is reduced, **L** is displayed on the screen.

4.3.11 Setting the antenna tuning power

■ Procedure ■

On the 5.5 Transmitter menu mentioned above, select the 2. Tune power and press ENT to move the cursor to the right, then select a value from 0 to 3 with the jog dial.

- The antenna tune output grows larger by about 5W step.
- The factory default setting is 0 (Normal).
- After selecting and pressing ENT, the settings are complete.

4.3.12 Setting the Auto Tune Start (ATS) function

■ Procedure ■

On the 5.5 Transmitter menu mentioned above, select the 3. Auto tune start and press ENT to move the cursor to the right, then set to ON or OFF with the jog dial.

- After setting to ON, when pressing the PTT key under the following condition in TEL mode, the antenna tuner starts tuning automatically.
 - When the Tx frequency is untuned, or
 - when the PA power is not turned on, i.e. the **ON** is not displayed.
- This ATS setting data is saved in the controller. Therefore if two controllers are connected, this function can be set to the controllers respectively.

4.4 Basic DSC operations

When calling stations, the DSC is also available for a routine, safety, urgency call or a distress alert. This section explains basics of how to use the DSC to make routine calls.

4.4.1 Routine calls to an individual station

For radiotelephone or telex communication, a DSC routine call to the station to be called can be made as follows.

■ Procedure ■

1. On the status display or operation display, holding down the **MENU** key, press **1** **CLAR** key to open "1. DSC non-distress call".

The screen as shown at right is displayed. The calling FRQ of 2177.0 kHz is the prescribed default value. But the working FRQ (MF) is rewritable.

Note

If no data is shown in the working FRQ field just after turning on, please contact JRC or our agency to register the nonvolatile data. In this case, the input MF data is stored temporarily as the volatile data.

```

1)DSC non-distress call
Call type : [RTN/Indv/TEL ]
Address   : [      ]
Calling FRQ: [ 2177.0kHz]
Working FRQ: [ 2150.0kHz]

[Call] [Preview] [Cancel]
    
```

2. Input the destination address.
 - If inputting the 9 digits MMSI manually, use the numeric keypad or the jog dial, or
 - If the DSC call list is already prepared, press **ENT** to open the station list as shown at right and select the receiver from the list.

```

1)DSC non-distress call
Call type : [RTN/Indv/TEL ]
No | Station name | MMSI
01 | JRC MITAKA1  | 123456789
02 | JRC MITAKA2  | 431012345
03 | JRC MITAKA3  | 431123456
04 | JRC MITAKA4  | 431234567
05 | JRC MITAKA5  | 431000123
06 | JRC MITAKA6  | 004310014
07 | JRC MITAKA7  | 431888888
    
```

3. The cursor is focused on the Call. To make a call without changing the parameters, press **ENT**.
 - To change the DSC calling frequency, select the Calling FRQ and press **ENT** to open the DSC call list as shown at right to select the channel. When inputting manually, press **CANCEL** to return to the column.
 - After changing the DSC calling frequency on HF, the working frequency is automatically selected within upto 10 seconds. However if no frequency is detected or if another frequency is needed, manually inputting the frequency is also available.
 - To check the details of the message, press **ENT** on the Preview menu to open the screen as shown at right (bottom).

```

1)DSC non-distress call
Call type : [RTN/Indv/TEL ]
Address   : [123456789]
Calling FRQ: [ 2177.0kHz]
Working FRQ: [ 2150.0kHz]

[Call] [Preview] [Cancel]
    
```

```

1)DSC non-distress call
Call type : [RTN/Indv/TEL ]
JRC MITAKA1 123456789
No | RX[kHz] | TX[kHz] | Category
01 | 2177.0  | 2177.0  | RTN
02 | 4208.0  | 4208.0  | RTN
03 | 4208.5  | 4208.5  | RTN
04 | 4209.0  | 4209.0  | RTN
05 | 6313.0  | 6313.0  | RTN
06 | 6313.5  | 6313.5  | RTN
    
```

```

1)DSC non-distress call
Format      : Individual
Address     : 123456789
Category    : Routine
Self-ID     : 431001234
Telecommand1: Radiotelephone
Telecommand2: No information
Working FRQ : Tx 2150.0kHz
              Rx 2150.0kHz
[Call] [Return] [Cancel]
    
```



- The operating display is appeared and initiates the DSC call

After checking the channel free condition, sends the message and waits for the acknowledgement.

Note During waiting for the acknowledgement, the handling menus are available for the following purposes.

Note) To focus the cursor on it, use **FUNC** or CANCEL key to move the active screen area.

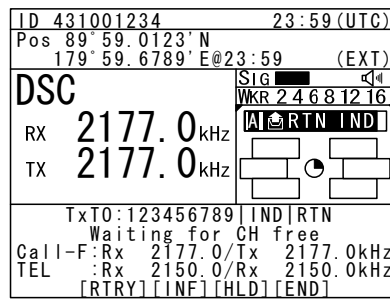
- RTRY...Resends the message.
- INF.....Indicates the message contents.
- HLD.....Makes the event on hold.
- ENDTerminates the event.



- When receiving the acknowledgement the ALM lamp starts blinking, and the receiving alarm starts sounding.

- Pressing **CANCEL** key or ENT silences the alarm.
- The radiotelephone frequency is set and the antenna is tuned automatically.

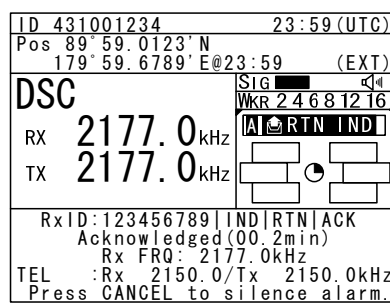

- When requested the radiotelephone communication, start the communication with the handset.

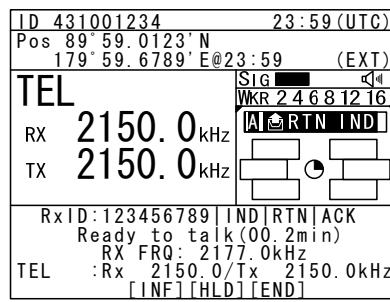

- Note**
- After completing the routine individual call where the ARQ or FEC is specified, the telex mode is set to the equipment. Then the telex communication can be started with the data terminal.
 - If the MMSI of the coast station is input at Address, the working frequency is specified by the coast station. Thus the Working FRQ line is disappeared.
 - If the receiver is unable to comply with the call, own station may receive one of the following acknowledgements. (* are coast stations only) In this case, wait and retry the call again later, if possible, according to the message.

No reason/ No reason given	No operator/ No operator available
Congestion/ Congestion at maritime switching centre *	Temp no operator/ Operator temporarily unavailable
Busy/ Busy	EQP disabled/ Equipment disabled
Queue/ Queue indication	Unable FRQ/ Unable to use proposed channel
Barred/ Station barred	Unable mode/ Unable to use proposed channel

4.4.2 Receiving routine individual calls

When receiving an individual DSC call from a coast or ship station, according to the message, perform the following procedures as appropriate.

■ Procedure ■

- The screen at right is displayed, and the ALM lamp blinks and the alarm grows louder gradually.
 - The example message contains the following information.
 - Message type: Routine individual call
 - Caller's MMSI: 123456789
 - If no procedure exists, starts operating the received message automatically.

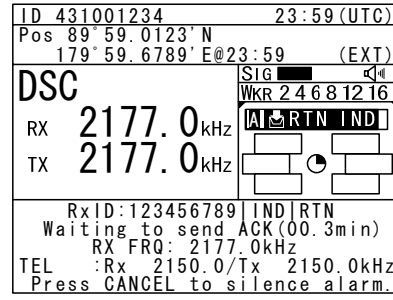

- Press the **CANCEL** key or ENT to stop the alarm, then the screen at right is displayed.

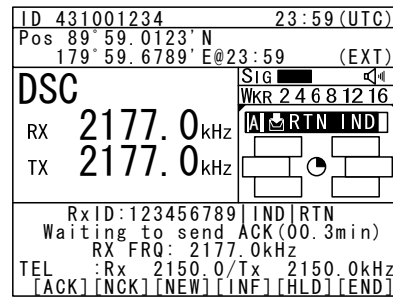

- Press **FUNC** key or ENT to move the focused screen to the operation control screen and select the option to handle the procedure.

Options shown at right are as follows.

- ACK..... Sends the acknowledgement.
- NCK Sends a reply as "unable to comply".
 Note) Select the unable reason on the popup screen at right.
- NEW Sends acknowledgement with a new channel.
- INF Indicates the receiving message.
- HLD Makes the procedure on hold.
- END Terminates the procedure.

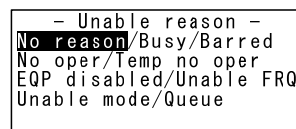
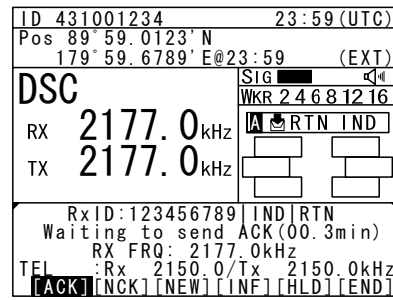

- When sending the acknowledgement for communication, select ACK and press ENT.

The equipment waits for the channel free condition as shown at right. After checking it, the acknowledgement is sent immediately.

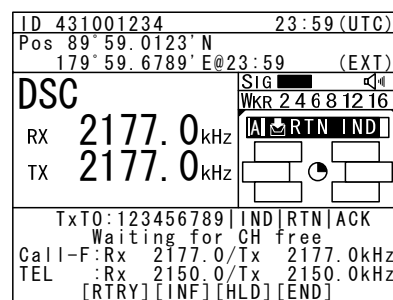

5. After sending an acknowledgement, the working frequency is set to communicate.

In TEL mode, start communicating using the handset.

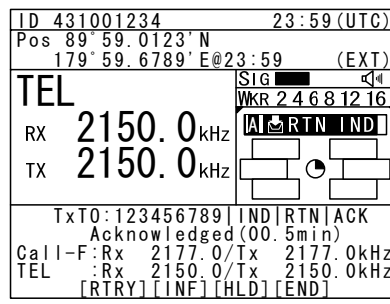

Note

- After completing the DSC call sequence specifying the ARQ or FEC, the telex mode is set to the equipment. Then the telex communication can be started with the data terminal.
- If the receiving call is not the above mentioned call which requests TEL or TLX communication but a polling call, the screen as follows is shown and, the ALM lamp blinks and the alarm grows louder gradually. In this case, after silencing the alarm, select ACK to acknowledge it.

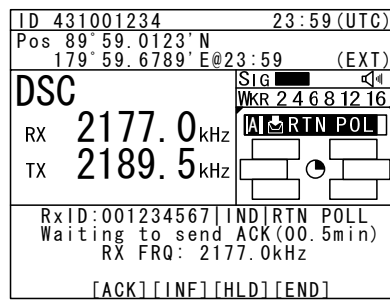

Additionally note that if it is received while the 7.5.1.3 Polling call of the Automatic ACK menu is set to ON, and there is no active procedure, this call can be acknowledged automatically.

4.4.3 Routine group calls

For radiotelephone or FEC broadcasting, a DSC routine call to a group of stations is available.

■ Procedure ■

1. On the menu “1. DSC non-distress call” mentioned above, set the Call type on the menu shown at right to RTN/Group/TEL or RTN/Group/FEC.

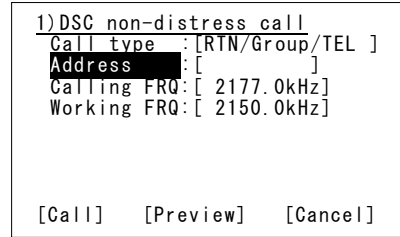

2. Input the Address, and frequency if required. And then press ENT on the Call to start sending the group call.

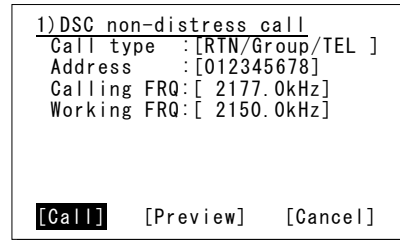

3. After finishing the transmission, the working frequency is set immediately.

In TEL mode, start broadcasting using the handset.

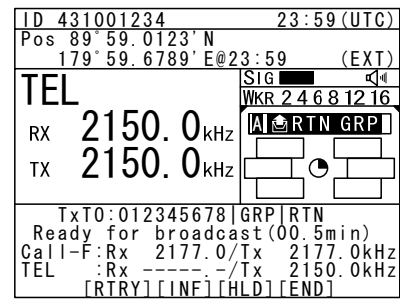

Note After completing the group call where the FEC is specified, the telex mode is set to the equipment. Then the telex communication can be started with the data terminal.

4.4.4 Receiving routine group calls

■ Procedure ■

The screen at right is displayed, and the ALM lamp blinks and the alarm grows louder gradually.

If no procedure exists, starts operating the received message, i.e. the specified working frequency is set automatically. Then press CANCEL to silence alarm and listen to the broadcasting.

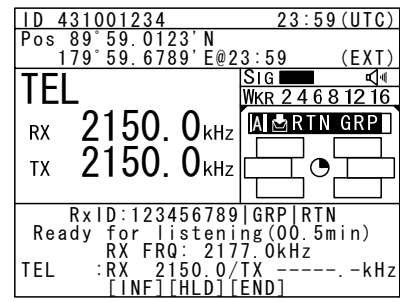

Note When receiving the group call where the FEC is specified, the telex mode is set to the equipment. Then receive the telex broadcasting with the data terminal.

4.5 Emergency calls (DSC distress/urgency/safety calls)

In emergency, the DSC is available for safety, urgency calls, or distress alerts. For safety and urgency calls, either individual or area calls is selectable for the type of call. For distress alerts, enabled to send either after entering the nature of distress or frequency, or without entering anything. In both cases, pressing the **DISTRESS** key is required to send the distress alert.

4.5.1 Safety or urgency calls to an individual station

■ Procedure ■

The procedure to send the safety or urgency individual call is similar to the routine call except selecting the call type to SAF/Indv/TEL or URG/Indv/TEL (instead of TEL, ARQ or FEC also available) and normally using the distress and safety frequencies prior to other frequencies.

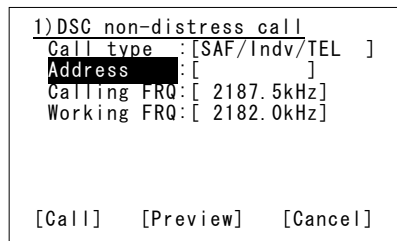

- Both calls of the safety test and the safety position request are described below.
- When calling a coast station with requesting the working frequency, input "0" in the Tx and Rx frequency input field to send the own position data.

4.5.1.1 Special safety individual calls

(1) Safety test calls

■ Procedure ■

1. Select SAF/Indv/Test in the Call type field and input address.

Also change the Calling FRQ if needed.

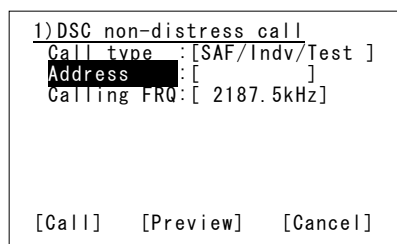

2. Press ENT on the Call to start sending the safety test call.

After checking the channel free, the safety test call is sent and the screen at right is displayed.

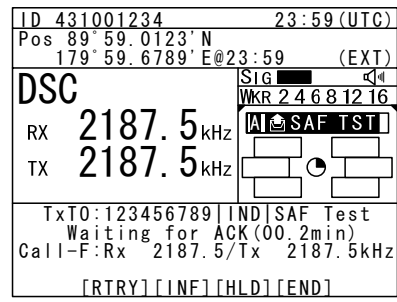

- When the acknowledgement is received, the ALM lamp blinks and the alarm starts sounding. After silencing it with **CANCEL** key, the screen becomes as shown at right.

The safety test call process is now complete. However note that even though the call is sent normally, the acknowledgement may not be received from the called station for some reason.

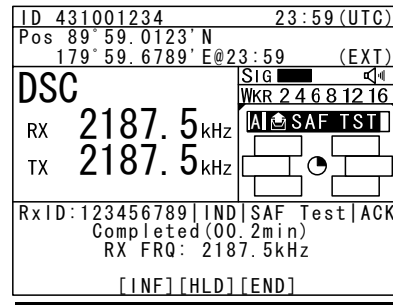

(2) Safety position request calls

■ Procedure ■

- Select SAF/Indv/PosRQ in the Call type field and input address.

Also change the Calling FRQ if needed.

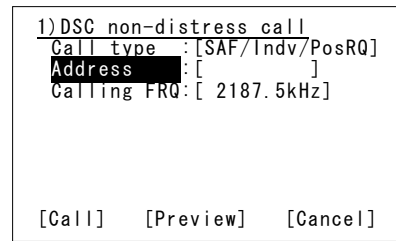

- Press ENT on the Call to start sending the safety position request call.

After checking the channel free, the safety position request call is sent and the screen at right is displayed.

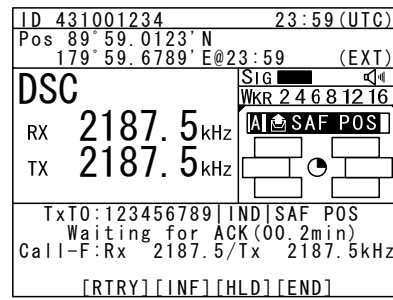

- When the acknowledgement is received, the ALM lamp blinks and the alarm starts sounding. After silencing it with **CANCEL** key, the screen becomes as shown at right.

The position data of the station is indicated in the Position field usually, and this procedure is complete. However note that even though the call is sent normally, the acknowledgement may not be received from the called station for some reason.

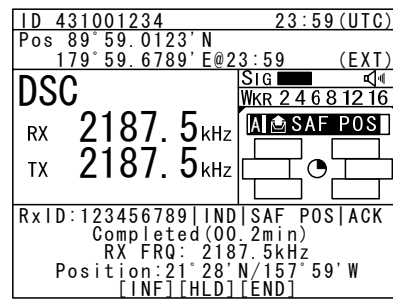

4.5.2 Receiving safety or urgency individual calls

When receiving an individual DSC call from a coast or ship station, according to the message, perform the following procedures as appropriate.

■ Procedure ■

The screen at right is displayed, and the ALM lamp blinks and the alarm grows louder gradually.

- If no procedure exists, starts operating the received message automatically.
- Basically similar to the routine individual call except normally using the distress and safety frequencies prior to other frequencies.

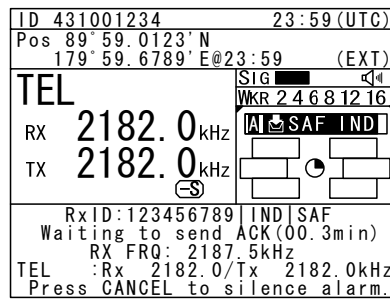

4.5.2.1 Receiving special safety individual calls

(1) Safety test calls

■ Procedure ■

The screen at right is displayed, and the ALM lamp blinks and the alarm grows louder gradually.

- If received while the 7.5.1.1 Test call of the Automatic ACK menu is set to ON and there is no active procedure, this call can be acknowledged automatically.
- To acknowledge manually, after silencing the alarm with **CANCEL** key, select ACK to start sending procedure.

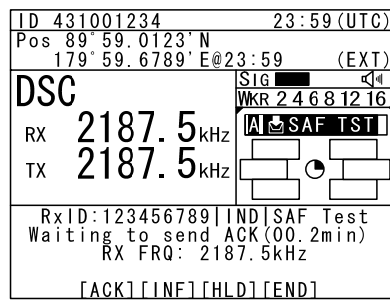

(2) Safety position request calls

■ Procedure ■

The screen at right is displayed, and the ALM lamp blinks and the alarm grows louder gradually.

- If received while the 7.5.1.2 Position RQ call of the Automatic ACK menu is set to ON and there is no active procedure, this call can be acknowledged automatically.
- To acknowledge manually, after silencing the alarm with **CANCEL** key, select ACK to start sending procedure.
- When sending a reply as “unable to comply”, select NCK to send the acknowledgement with no position data.

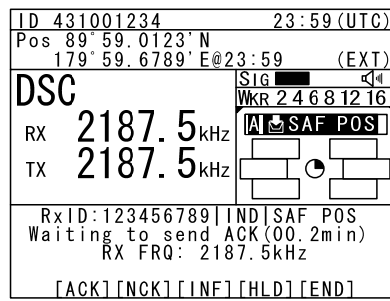

4.5.3 Safety or urgency area calls

For radiotelephone or FEC broadcasting, a DSC safety area call can be made as follows.

■ Procedure ■

1. On the menu 1.DSC non-distress call, set the Call type to SAF/Area/TEL or URG/Area/TEL (instead of TEL, FEC also available).

The menu becomes as shown at right and the cursor moves to the Area form.

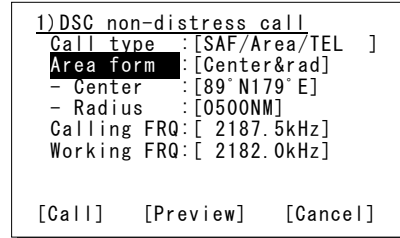

2. Set the area to call.

Input as below according to the Area form settings.

- When Center&rad
 - Enter the center point of the area in Center.
 - Enter the radius of the area in Radius.
- When Corner&dev (shown at right)
 - Enter the northwest corner of the area in Corner.
 - Enter the south and north/east and west deviation in a range from 00 to 99 in Deviation.

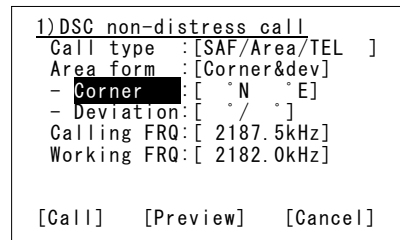

3. Select the Working FRQ/ Calling FRQ if needed, then press ENT to start the area call.

4. After finishing the transmission, start the communication with the handset in TEL mode.

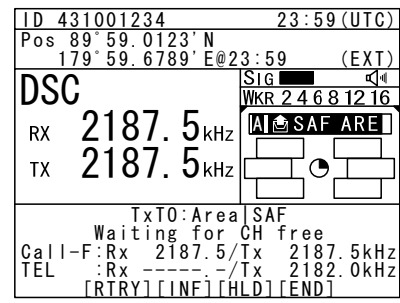

Note

- In case of the urgency call, to inform receivers of the particular topic, additional settings such as Medical TRNSP (medical transport ship) or Neutral ship (neutral nationality) in the Subject field as shown at right are available. However to use this function, it is needed to set the menu 7.5.4 Medical use or 7.5.5 Neutral use to ON once after powering on the equipment.

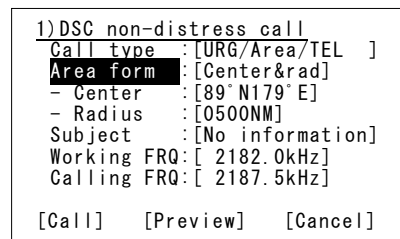

- After finishing the area call where the FEC is specified, the telex mode is set to the equipment. Then start the telex communication with the data terminal.

4.5.4 Receiving safety or urgency area calls

■ Procedure ■

The screen at right is displayed, and the ALM lamp blinks and the alarm grows louder gradually.

If no procedure exists, starts operating the received message, i.e. the specified working frequency is set automatically. Then press **CANCEL** to silence alarm and listen to the broadcasting.

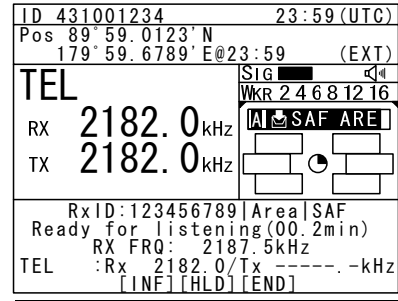

Note

- When receiving the area call where the FEC is specified, the telex mode is set to the equipment. Then receive the telex broadcasting with the data terminal.
- To check the topic when receiving an urgency area call, select INF menu to view the detail of the message.

4.5.5 Distress alerts

When in distress, distress alerts are always transmitted by pressing the dedicated **DISTRESS** key. The distress alerts transmit your own MMSI, ships position, time of the position, and the nature of distress.

⚠ CAUTION



Do not test the distress alert.
Doing so may inconvenience local shipping and rescue centers.



When sending a distress alert, follow the instructions of the ship's captain or officer in charge.



If a false distress alert is transmitted accidentally, select the Cancel menu and transmit the distress cancel referring the guidance displayed on the controller. And then report the false distress alert to a nearby RCC (Rescue Coordination Center/ in Japan, inform the nearest Japan Coast Guard.)
Information to be reported:
Ship's name, type, nationality, and ID number, the date/time, location and reason why the false distress alert was transmitted. Also the unit model name and manufacture number/date, if possible.

4.5.5.1 Quick distress alerts

The following describes the procedure to send a distress alert immediately without using menus. In this case, the nature of distress in the message will be sent as "Undesignated" by default. Further, if no information for the position and the time of position obtained within 23.5 hours, this information will be composed automatically.

■ **Procedure** ■

1. Open the **DISTRESS** key cover.



2. Press and hold the **DISTRESS** key for 4 seconds until the countdown is completed.

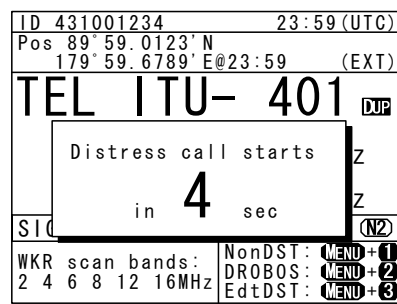

3. After the antenna is tuned, the distress alert is sent.

The distress alerts are sent on all 6 distress and safety frequencies.

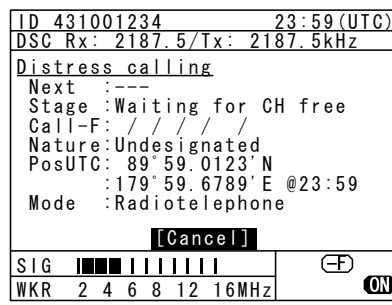

4. The equipment stays in distress mode until acknowledgement is received or the distress alert cancelling procedure is complete.

- Unless an acknowledgement is received or the distress alert is cancelled manually, the distress alert repeats automatically in a variable interval every 3.5 to 4.5 minutes. (The time until next sending is shown at Next.)

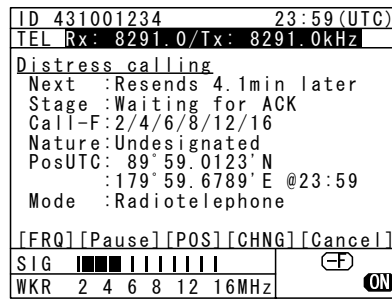

- The distress alert can be sent manually while waiting for acknowledgement by the **DISTRESS** key operation mentioned above.
- While waiting for the acknowledgement, the radiotelephone communication is available. Additionally, when focusing the frequencies as shown at right, the distress and safety frequency can be changed with the jog dial.

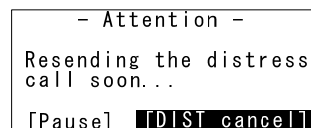

- Pressing CANCEL key or ENT moves the focused screen and makes following options available.

FRQ.....Moves the cursor to the frequency section

PauseMakes the distress mode pause.

POS.....Opens the position input menu

CHNGChanges the distress alert type (Multi/Single mode and the frequencies)

Cancel.....Starts the distress alert cancelling procedure, which is needed to send the DSC acknowledgement and to broadcast in the radiotelephone mode from the "own ship".

Furthermore, if the POS/CHNG is edited, **MEM** icon is displayed to indicate that there are some data stored temporarily until resending the distress alert.

5. When the acknowledgement is received, the message is displayed as shown at the right.

- The ALM lamp starts blinking, and the receiving alarm starts sounding.
- The radiotelephone mode is set to the distress/safety frequency of the band on which the acknowledgement is received and antenna tuning is done immediately.

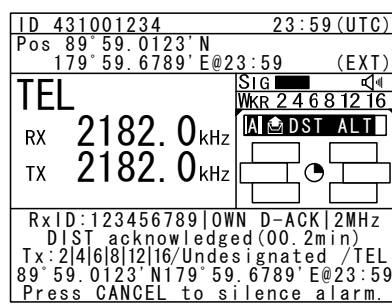

- Press the **CANCEL** key or ENT to silence the alarm, then call for help with the handset. Normally, the responding station calls on the radiotelephone. Then reply to the receipt as follows.

- Say, "MAYDAY".
- Say, "This is".
- Own ship's MMSI and call sign, position, nature of distress, and rescue requests

Note

If cancelling the distress alert since a false distress alert is transmitted accidentally, perform the distress alert cancelling procedure as follows.

1. Press the **CANCEL** key while the option selectable screen is focused.

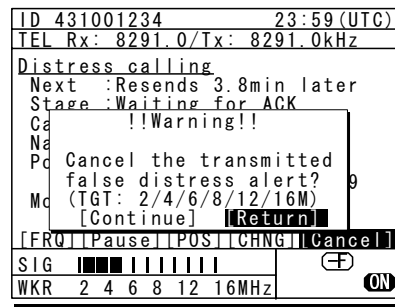

2. On the popup screen, select Continue with the jog dial, and press ENT.

Starts the distress alert cancelling procedure and sends the DSC acknowledgements to own ship in every frequency where distress alerts are transmitted.

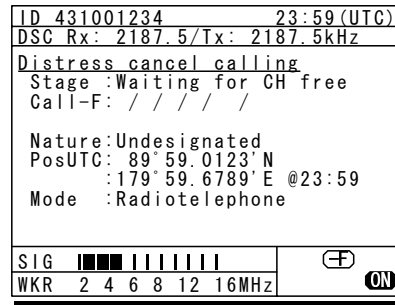

3. After DSC acknowledgements are complete, the popup screen is displayed as shown at right.

If the false distress alert indicates the FEC mode, the popup screen is displayed as shown at lower right. In this case, the message for cancelling distress alert is sent in the TLX mode automatically without operating the DTE.

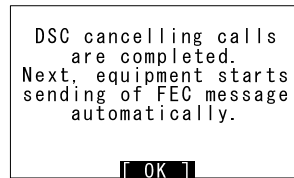
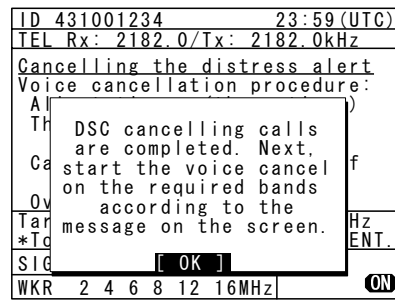

4. According to the guidance on the screen, broadcast to cancel the distress alert in TEL mode.

- When finishing the broadcast on a frequency, press ENT to change to the next frequency.
- The cancelled frequency shows ✓ mark.

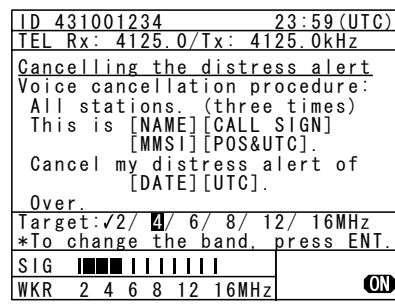

5. When the cancelling procedure is completed on every frequency, displays the operating screen as shown at right and finishes the distress mode.

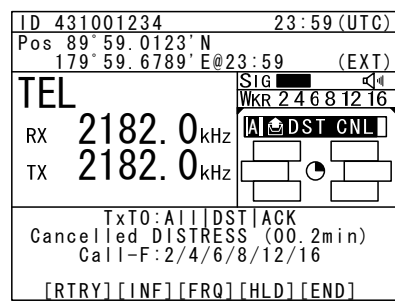

4.5.5.2 Distress alerts from the menu

Attention

During communicating in telex mode, finish it to enable the menu before practicing below.

The following describes the procedure to send a distress alert with the nature of distress selected in the menu. Also, besides manually inputting position and the time information, the subsequent communication mode, the transmission method and frequency can be set here.

Note: Multi-frequency or single frequency can be selected as the transmission method. The various methods are shown below.

- Multi-frequency method: The distress alert message is sent continuously on each frequency, 2187.5 kHz, 8414.5 kHz, and at least one other distress/safety frequency.
- Single frequency method: The same distress alert message is sent on one distress/safety frequency 5 times continuously. If 2 or more distress/safety frequencies are selected, the same message is transmitted 5 times continuously in the same way on the other frequency after an interval between 3.5 to 4.5 minutes (variable).

■ Procedure ■

- On the status display or operation display, while pressing and holding **MENU** key, press **3 NR** key to open "3. Editing a distress msg".

The distress type is displayed as Undesignated as a default value. If the position information is input automatically by a GPS type device, or has already input manually, that information is also displayed.

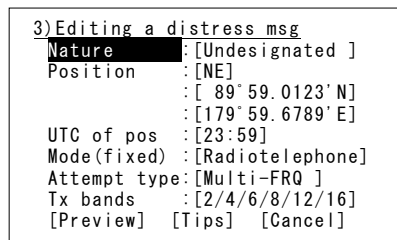

- Press ENT and select the nature of distress.

The nature of distress is selectable from below.

Nature of distress	Contents
Fire	Fire, explosion
Flooding	Flooding
Collision	Collision
Grounding	Grounding
Listing	Listing, in danger of capsizing
Sinking	Sinking
Disabled	Disabled and adrift
Undesignated	Undesignated distress
Abandoning	Abandoning ship
Piracy attack	Piracy/armed robbery attack
Man overboard	Man overboard

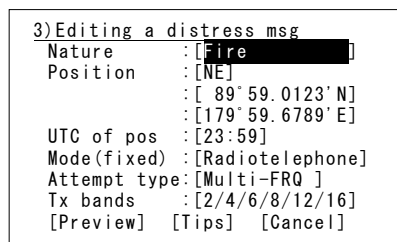

Operation

3. Press ENT.

The cursor moves to Position. If a valid position and time of that position are already displayed, no entry is necessary. Skip to step 6.

```
3)Editing a distress msg
Nature      :[Fire      ]
Position    :[NE]
            :[ 89° 59. 0123' N]
            :[179° 59. 6789' E]
UTC of pos  :[23:59]
Mode(fixed) :[Radiotelephone]
Attempt type:[Multi-FRQ ]
Tx bands    :[2/4/6/8/12/16]
[Preview] [Tips] [Cancel]
```

4. Press ENT and select the quadrant of the position with the jog dial.

The quadrant changes from NE → NW → SE → SW → CL. Select CL to delete the input information.

```
3)Editing a distress msg
Nature      :[Fire      ]
Position    :[NW]
            :[ 89° 59. 0123' N]
            :[179° 59. 6789' E]
UTC of pos  :[23:59]
Mode(fixed) :[Radiotelephone]
Attempt type:[Multi-FRQ ]
Tx bands    :[2/4/6/8/12/16]
[Preview] [Tips] [Cancel]
```

5. After pressing ENT, input the latitude, longitude, and time using the numeric keypad.

```
3)Editing a distress msg
Nature      :[Fire      ]
Position    :[NW]
            :[ 89° 59. 0123' N]
            :[179° 59. 6789' W]
UTC of pos  :[23:59]
Mode(fixed) :[Radiotelephone]
Attempt type:[Multi-FRQ ]
Tx bands    :[2/4/6/8/12/16]
[Preview] [Tips] [Cancel]
```

6. Press ENT and select the Mode to change the subsequent communication mode after the DSC call.

Either of Radiotelephone or FEC is selectable for the subsequent communicate mode.

```
3)Editing a distress msg
Nature      :[Fire      ]
Position    :[NW]
            :[ 89° 59. 0123' N]
            :[179° 59. 6789' W]
UTC of pos  :[23:59]
Mode        :[Radiotelephone]
Attempt type:[Multi-FRQ ]
Tx bands    :[2/4/6/8/12/16]
[Preview] [Tips] [Cancel]
```

7. Move the cursor to Attempt type and press ENT to change the transmission method for the distress alert.

Multi-frequency method is set as the default. To change to the single frequency method, select Single-FRQ with the job dial and press ENT.

```
3)Editing a distress msg
Nature      :[Fire      ]
Position    :[NW]
            :[ 89° 59. 0123' N]
            :[179° 59. 6789' W]
UTC of pos  :[23:59]
Mode(fixed) :[Radiotelephone]
Attempt type:[Single-FRQ]
Tx bands    :[2/4/6/8/12/16]
[Preview] [Tips] [Cancel]
```

8. Move the cursor to Tx bands and press ENT to change the transmission frequency for the distress alert.

- At first, all the frequencies are selected as transmission frequencies.
- To change the frequencies, move the cursor by pressing ENT to the frequencies (band) to be unselected, turn the jog dial so they are blank and press ENT.
- For the Multi-frequency method, 2 and 8 are fixed and are skipped. Also in this case, it is necessary to select more than one other band.
- After completing the Tx bands settings, the cursor returns to Nature.

```
3)Editing a distress msg
Nature      :[Fire      ]
Position    :[NW]
            :[ 89° 59. 0123' N]
            :[179° 59. 6789' W]
UTC of pos  :[23:59]
Mode(fixed) :[Radiotelephone]
Attempt type:[Single-FRQ]
Tx bands    :[2/ /6/8/12/16]
[Preview] [Tips] [Cancel]
```

Note If pressing **DISTRESS** key during the Tx bands settings (before fixing by pressing ENT), the distress alerts are sent on the band(s) registered previously.

9. Open the **DISTRESS** key cover.



10. Press and hold the **DISTRESS** key for 4 seconds until the countdown is completed.

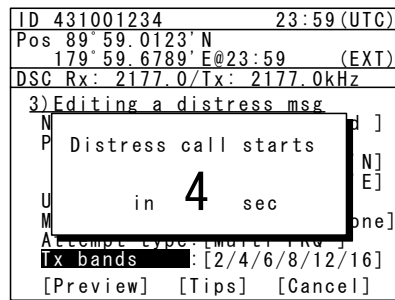

- Note**
- The rest of the procedure is the same as described in the "Quick distress alert".
 - Select Preview and press ENT before calling to display the details of the message as shown below.

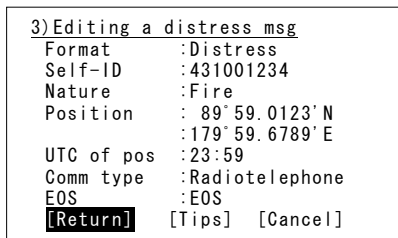

- Select Tips and press ENT to display precautions about operations in this screen in a popup screen as shown below.

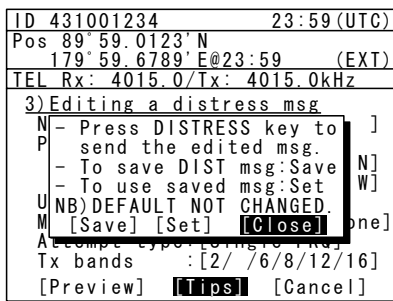

This popup screen shows the following messages and the handling menus;

- When sending the edited message, use the DISTRESS key as mentioned above.
- To save the edited message (except Pos/UTC), select Save and press ENT.
- To load the saved message (except Pos/UTC), select Set and press ENT.
- The default values of "3. Editing a distress msg" are not changed.

4.5.5.3 Receiving distress alerts

When a distress alert is received from another ship, displays the event immediately with the specific two-tone alarm sound.

! WARNING

If a distress alert is received, make sure to inform the ship's captain or officer in charge. Doing so may save the lives of the crews and passengers on the ship in distress.

■ Procedure ■

1. When a distress alert is received, the distress message is displayed.
 - The ALM lamp starts blinking, and the receiving alarm gradually grows louder. However, the aural alarm keeps silence if the distress position is not within 500nm, and is not in the polar areas (greater than 70°N/S).
 - If no procedure exists, starts operating the received message automatically.

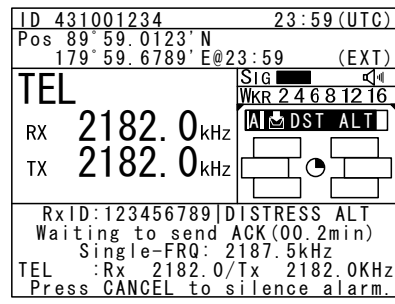

2. Press the **CANCEL** key or ENT to stop the alarm. Then the screen at right is displayed.
 - Keep watch for at least 5 minutes. Notify the coast station as appropriate.
 - If received the same distress alert on another frequency again, the right lower screen is displayed. Then pressing ENT on Accept or leaving 10 seconds changes the frequency to 8291.0 kHz for the radiotelephone mode or 8376.5 kHz for the telex mode.
 - Press **FUNC** key or ENT* to move the focused screen to the operation control screen and select the following options to handle the procedure.
 - * If the **A** mark is not displayed, press ENT to activate this procedure.

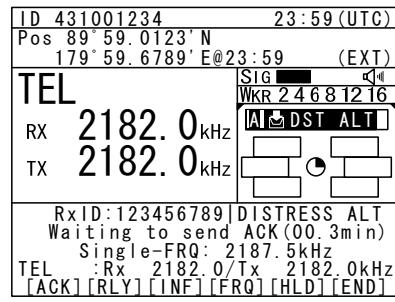

SAME DST ON ANOTHER FRQ
 From : 123456789
 Work-F : 8291.0kHz
 EQP will tune to the
 above FRQ within 10s.
[Accept] [Ignore]

- ACK..... Sends the acknowledgement to the distress alert.
- RLYSends the distress relay.
- INF Indicates the received distress message.
- FRQ..... Changes the watchkeeping frequency.
- HLD Makes the procedure on hold.
- END..... Terminates the procedure.

- Note**
- The distress acknowledgement is normally sent from a coast station. However after consulting with the RCC or a coast station and being directed, it is possible to acknowledge the ship in distress from your own ship.
 - If the distress alert is not received at 2187.5 kHz, the acknowledgement is inhibited and cannot be sent.
 - In case of the radiotelephone specified, after sending the acknowledgement the frequency is set to 2182.0 kHz. Then start the radiotelephone communication

with the ship in distress according to the following procedure.

- Say "MAYDAY".
 - Repeat the identity (MMSI) of the ship in distress 3 times
 - Say "This is..."
 - Repeat the identity (MMSI) of your ship 3 times
 - Say "RECEIVED MAYDAY".
- In case of the FEC specified, after sending the acknowledgement the frequency is set to 2174.5 kHz. Then start the telex communication with the data terminal.
 - The distress relay calls may be received without receiving the distress alert. In this case, keep watch the distress frequency and handle the message using the displayed options as appropriate.

4.5.6 Distress relay calls on behalf of someone else (DROBOSE)

If another ship is in distress but is itself unable to make a distress alert, and the master of the ship considers that further help is necessary, the distress relay call on behalf of the ship can be transmitted using the "DSC drobose call" menu. In this case, compose a distress relay call format by inputting the MMSI (if known), the ship's position and the time of position (if known), and the nature of distress to send to a specific area or a coast station.

⚠ CAUTION

When sending a drobose call, do NOT press the **DISTRESS** key. Doing so may cause a false distress alert.

(Drobose calls can be sent via the [Call] button displayed on the screen.)

■ Procedure ■

1. On the status display or operation display, while pressing and holding **MENU** key, press **2SCAN** key to open "2. DSC drobose call".

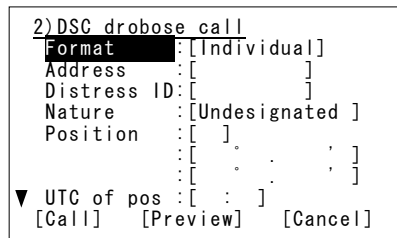

2. Select Address and press ENT, input the MMSI of the calling coast station.

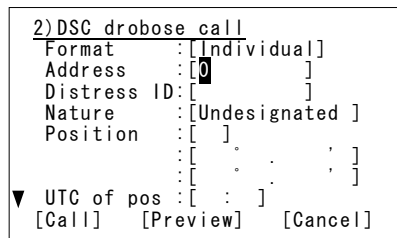

Operation

- Input the Distress ID (MMSI) of the ship in distress, Nature, Position and/or UTC, if known.

The nature of distress is selectable from below.

Nature of distress	Contents
Fire	Fire, explosion
Flooding	Flooding
Collision	Collision
Grounding	Grounding
Listing	Listing, in danger of capsizing
Sinking	Sinking
Disabled	Disabled and adrift
Undesignated	Undesignated distress
Abandoning	Abandoning ship
Piracy attack	Piracy/armed robbery attack
Man overboard	Man overboard

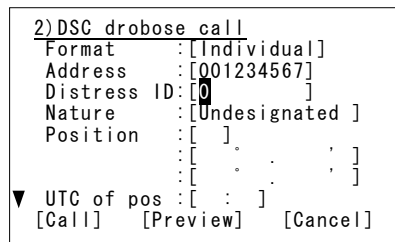

- If required, change the communication mode and/or the calling frequency to send the drobose call.

Mode: Radiotelephone or FEC
 Calling FRQ: Distress and safety frequency (2/4/6/8/12/16 MHz)

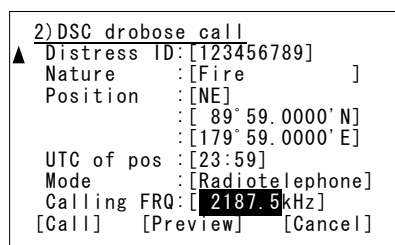

- Select Call and press ENT to make a drobose call.

After sending the drobose call, TEL mode is set while waiting for the acknowledgement as shown at right. In this case, the watchkeeping receiver stops scanning frequencies to watch only the calling frequency as shown at right.

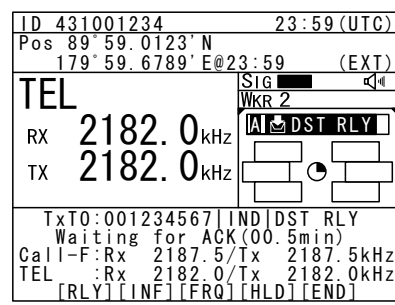

- When receiving the acknowledgement from the coast station, the screen shows as shown at right.

- The ALM lamp starts blinking, and the receiving alarm starts sounding.
- Press the **CANCEL** key or ENT to silence the alarm, then start the distress traffic.

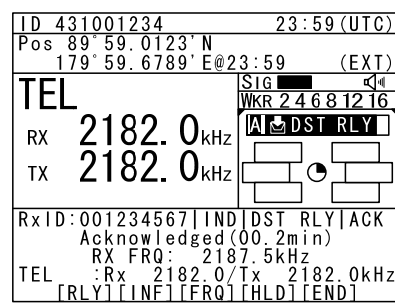

Note

Such messages can be sent using Area format. In this case, select Area (centre or corner) for the broadcast communication.

4.6 DSC call log

DSC messages are classified as received distress messages, received other messages and transmitted messages. The 20 most recent messages for every type are saved in the log.

⚠ CAUTION





Received distress message logs are automatically deleted after 48 hours to avoid accidental resending or other misoperation. Accordingly, if such messages cannot be read, it is not a malfunction.

The received distress message logs are cleared when turning off the power by such as the breaker on the transceiver. Due to the SOLAS Convention (keeping watch on distress and safety frequencies at all times), do not turn off the equipment when at sea.

4.6.1 Received distress messages

The distress alerts, the distress acknowledgements, the distress relay calls, and the distress relay acknowledgements are stored in this log. For the distress alerts, the messages with the same content are received at a maximum of 6 messages for the multi-frequency method or a maximum of 5 messages for the single frequency method, but only one is stored unless otherwise closed the received message during that multiple receptions.

■ Procedure ■

1. Press the **MENU** key, and through hierarchical menus, select “4.1 Received distress”.
 - On the bottom line, the MMSI of the ship is displayed highlighted by the cursor.
 - If the message includes a reception error (ECC error) ERR is shown in the CAT field.

ID 431001234		23:59 (UTC)	
Pos 89° 59.0123' N			
179° 59.6789' E@23:59 (EXT)			
TEL Rx: 4125.0/Tx: 4125.0kHz			
4.1) Received distress			
No	Date/Time	CAT	Format
01	2008-08-01 23:31	DST	INDIV
02	2008-07-31 10:33	DST	INDIV
03	2008-07-31 10:25	DST	AREA
04	2008-07-31 10:03	---	DSTRS
05	2008-07-19 22:53	ERR	DSTRS
From: 431000123			

2. Select a displayed message and press ENT.

ID 431001234		23:59 (UTC)	
Pos 89° 59.0123' N			
179° 59.6789' E@23:59 (EXT)			
TEL Rx: 2065.0/Tx: 2065.0kHz			
Received distress message			
Type	: Distress		
From	: 003456789		
Nature	: Man overboard		
Position	: 12° 34.0000' N		
	: 123° 45.0000' E		
UTC of pos:	: 11:20		
Mode	: Radiotelephone		
▼ EOS	: EOS		
[Close]			

4.6.2 Received other messages

Received messages other than the distress (routine, safety, and urgency) are stored in this log.

■ Procedure ■

1. Press the **MENU** key, and through hierarchical menus, select “4.2 Received others”.

- On the bottom line, the MMSI of the ship is displayed highlighted by the cursor.
- If the message includes a reception error (ECC error) ERR is shown in the CAT field.

ID 431001234	23:59(UTC)		
Pos 89°59.0123'N	179°59.6789'E@23:59 (EXT)		
DSC Rx: 2177.0/Tx: 2177.0kHz			
4.2) Received others			
No	Date/Time	CAT	Format
01	2008-07-31 11:00	RTN	INDIV
02	2008-07-22 18:17	SAF	AREA
03	2008-07-22 18:17	URG	AREA
04	2008-07-19 22:53	ERR	INDIV
From: 003456789			

2. Select a displayed message and press ENT.

The selected message is displayed.

ID 431001234	23:59(UTC)
Pos 89°59.0123'N	179°59.6789'E@23:59 (EXT)
TEL Rx: 2065.0/Tx: 2065.0kHz	
Received routine message	
Type	: Individual call
From	: 123456789
Mode	: Radiotelephone
Work FRQ	: Tx 2065.0kHz
	: Rx 2065.0kHz
EOS	: ACK RQ
Rx FRQ	: 2177.0kHz
[Close]	

4.6.3 Transmitted messages

Every transmitted message is stored in this log.

■ Procedure ■

1. Press the **MENU** key, and through hierarchical menus, select “4.3 Transmitted calls”.

On the bottom line, the MMSI of the ship is displayed highlighted by the cursor.

ID 431001234	23:59(UTC)		
Pos 89°59.0123'N	179°59.6789'E@23:59 (EXT)		
DSC Rx: 2177.0/Tx: 2177.0kHz			
4.3) Transmitted calls			
No	Date/Time	CAT	Format
01	2008-07-31 11:00	RTN	INDIV
02	2008-07-22 18:17	SAF	AREA
To: 123456789			

2. Select a displayed message and press ENT.

The selected message is displayed.

ID 431001234	23:59(UTC)
Pos 89°59.0123'N	179°59.6789'E@23:59 (EXT)
TEL Rx: 2065.0/Tx: 2065.0kHz	
Transmitted routine message	
Type	: Individual call
To	: 123456789
Mode	: Radiotelephone
Work FRQ	: Tx 2065.0kHz
	: Rx 2065.0kHz
EOS	: ACK RQ
Tx FRQ	: 2177.0kHz
[Close]	

4.7 Display of telex communication logs

The telex communication is saved automatically as the log, and the reference is available later.

■ Procedure ■

1. If displaying the message of "Press Enter key to get the access right in the NBDP mode..." on the data terminal, press Enter key on the keyboard.

The operation of the data terminal becomes possible in the telex mode, except when the controller is used.

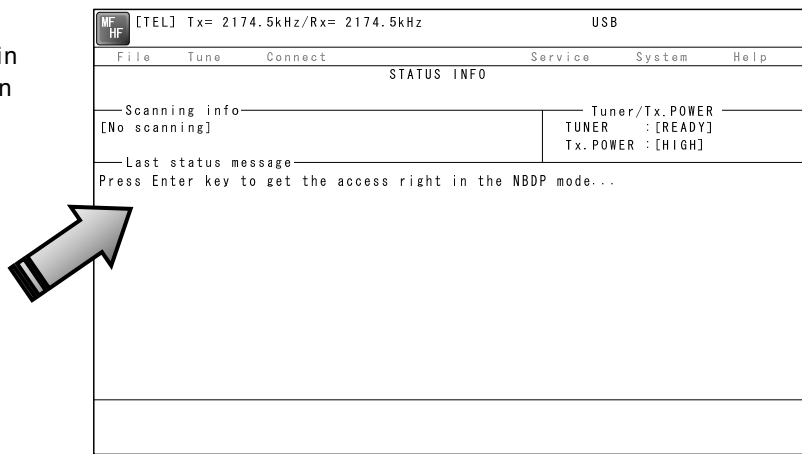

2. On the main menu and the dropdown menu, select Service → Call logging history with Enter key.

The list of the log as shown at right is displayed.

Call logging history					
No.	File name	Date	Time	Size	
1	00000010.LOG	20 Aug. 10	11:29	10 B	[View]
2	00000009.LOG	16 AUG. 10	08:33	123 B	[Print]
3	00000008.LOG	16 AUG. 10	07:57	2234 B	[Cancel]
4	00000007.LOG	15 JUL. 10	22:56	138 B	
5	00000006.LOG	15 JUL. 10	22:53	162 B	
6	00000005.LOG	15 JUL. 10	22:48	1102 B	
7	00000004.LOG	15 JUL. 10	22:10	256 B	
8	00000003.LOG	14 JUL. 10	19:25	3356 B	
9	00000002.LOG	14 JUL. 10	18:56	202 B	
10	00000001.LOG	14 JUL. 10	18:30	111 B	↓

F2: Sort by Name

3. Move the cursor to the objective file referring to the timestamp and press Enter key to view it.
 - The file content on the viewer scrolls by the ↑ ↓ key.
 - To close the file viewer, press the ESC key.

Note The maximum size of a log file is 8192 bytes. When exceeding it, the excess data are stored in another file.

4.8 USB memory operation

This section describes how to use the USB memory.

Attention

- The following conditions are required for the USB memory.
 - Note) Not all USB memories satisfying the every condition are guaranteed.
 - The specification is complied with USB 1.1 or USB 2.0 standards.
 - No USB hub is built-in and is used to connect the USB memory.
 - No security function such as encryption or password to access is included.
 - No write-protect function is included, or that function is set to "Writable".
 - Already formatted with FAT16 or FAT32 by Windows® OS.
- Only the USB memory is connectable to the USB memory connector.
- When the USB memory size is large, the file access time will be longer than small one.
- The files or folders named with multibyte character prepared by other than the data terminal cannot be accessed.
- If the USB memory is removed, always close the connector with the rubber cap to ensure the water-proof and dust-proof performance.
- Initializing the USB memory will erase all data on the USB memory.
- To avoid abnormal conditions, do not use the USB memory that has the broken file system.

■ Procedure ■

1. If displaying the message of "Press Enter key to get the access right in the NBDP mode..." on the data terminal, press Enter key on the keyboard.

The operation of the data terminal becomes possible in the telex mode, except when the controller is used.

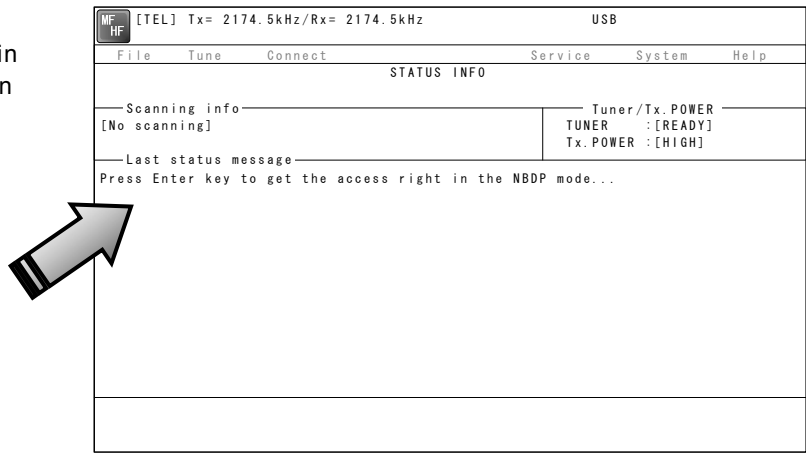

2. After checking the USB mark indicating on the top of the display of the data terminal, select File from the main menu and the objective dropdown menu.
 - To start either one of Edit existing file, Rename file, Delete file, or Copy file, input "A:" as the USB drive.
 - To initialize the USB memory, select Initialize USB and operate in accordance with the message on the dialog box.
 - To unmount the USB memory, select Remove USB and operate in accordance with the message on the dialog box. After completing the unmount and the USB mark of the top of the display is erased, the USB memory can be safely removed from the data terminal.

4.9 Popup screens

The contents of the popup screens of the data terminal are as follows (in alphabetical order).

Message	Buttons	Description
Attention Are you sure to erase?	Yes/ No	Is it OK to delete a file? Yes: Deletes the file. No: Cancels this operation.
Attention Are you sure to initialize all of these accessible setup data?	Yes/ No	Is it OK to initialize the all items where the cursor can be located. Yes: Initializes them. No: Cancels this operation.
Attention Do you really want to change column width?	Yes/ No	Is it OK to change the column width of a line? Yes: Changes the column width. No: Cancels this operation.
Attention Formatting will erase all data on the USB memory. To format the USB memory, choose Yes.	Yes/ No	All the data of USB memory is deleted by the format operation. Yes: Formats the USB memory. No: Cancel the format.
Attention Keyboard input unavailable now. The connected controller is in operation.	----	The controller is in operation such as menu and the data terminal cannot be operated now.
Attention The antenna tuning is started by the controller. Wait a moment, please.	----	Now tuning the antenna with the controller, and unavailable for a while.
Attention The current database will be lost. Are you sure to continue?	Yes/ No	Is it OK to overwrite the current database file to save the new one? Yes: Overwrites the current file. No: Cancels this operation.
Attention The DTE cancels the print request for the DTE printing buffer overflow.	OK	The print request from the controller or by the data terminal operation has been refused for the printing buffer overflow.
Attention The file size exceeds the maximum value, so the DTE deletes excess data. Are you sure?	Yes/ No	When saving a file, detected the file size is exceeding the 8kB. The data terminal can delete the excess data and continue to save the file. Yes: Continues the process. No: Cancels this operation.
Attention The maximum field size is reached.	OK	The editing message file size is now beyond 8kB. Please downsize it.
Attention The same file name already exists. Do you overwrite it?	Yes/ No	The same file name exists. Is it OK to overwrite it? Yes: Overwrites the current file. No: Cancels this operation.
Block has not marked. This function is impossible now.	OK	No block is selected and refused the request. Select a block in advance.
Confirmation Is the frequency free now?	Yes/ No	Check the frequency is busy or not. Yes: Continues the process. No: Returns to the menu
Continue Search?	Yes/ No	Continue searching the string specified? Yes: Continues searching. No: Cancels this operation.

Operation

Message	Buttons	Description
Error File access failed.	OK	The specified file cannot be used for any malfunction.
Error Invalid file.	OK	The file is malformed and invalid.
Error Keyboard I/F ROM checksum error.	OK	Detected the keyboard I/F ROM checksum error.
Error No folder exists.	OK	A specified folder is not found.
Error No response.	OK	The controller may be busy and returns no reply to the data terminal.
Error Overcurrent has been detected at the USB port.	OK	The attached USB device may be failure.
Error Register the 9-digit Self-ID in advance.	OK	Own station ID (9digit selcal number) is needed to call the station by the 9 digit selcal number.
Error Register this station's ID in advance.	OK	Own station ID is needed to call the station in the telex mode.
Error The antenna is not tuned correctly. Tune to the frequency now?	Yes/ No	The antenna is not tuned. Starts the antenna tuning immediately? Yes: Tunes immediately. No: Tuning is not needed.
Error The attached USB device is not supported. The DTE supports the USB memory only.	OK	The data terminal detects the USB device except the USB memory.
Error The DTE failed to access to the file system.	OK	The file system and the files are inaccessible now.
Error The DTE failed to print.	OK	Printing is unavailable now.
Error The DTE failed to stop the USB drive.	OK	The USB drive cannot be unmounted.
Error The DTE was unable to complete the format. Please remove the USB memory.	OK	The data terminal failed to format the USB memory, so remove the USB memory.
Error The file is too large.	OK	The specified file cannot be opened because of the file size beyond the 8kB.

Message	Buttons	Description
Error The file name extension is allowed only "DB".	OK	Input "DB" as the correct extension.
Error The file name extension is allowed only "TLX".	OK	Input "TLX" as the correct extension.
Error The file name is wrong.	OK	The specified file is not found, or the file name to be copied is wrong.
Error The file saving failed. There is not enough room on the DTE drive.	OK	No file can be saved because the data terminal has no sufficient vacant memory.
Error The keyboard is disconnected.	----	The keyboard is disconnected and no control for the data terminal is available now.
Error The keyboard is not ready.	----	Malfunction is detected at the keyboard I/F and the keyboard is no longer available now.
Error The memory is already full. So you cannot make a new file.	OK	The number of files exceeded maximum value (100), so a new file cannot be made.
Error The printer is not ready. Check the paper and online status.	OK	The printer cannot be used. Confirm that paper is put on or that it is online.
Error The same file name already exists.	OK	This file name already exists, and is no longer available now.
Error The station ID is not present.	OK	SELCAL number (ID) is not registered in the specified radio station.
Error There is a possibility of the USB IC failure. All USB functions are disabled.	OK	Detected the USB IC failure. And now out of work here.
Error There is not enough room on the DTE main drive. Delete some files, or change the folder.	OK	The data terminal has no sufficient vacant memory. Delete files or change the folder adequately.
Error There is not enough room on the USB drive. Delete some files, or change the folder.	OK	The USB memory has no sufficient vacant area. Delete files or change the folder adequately.
Error Two or more channels are needed.	OK	Register two or more channels to start scanning of the specified station..
Error Tx/Rx frequency is not present.	OK	The frequency is not registered in the specified radio station.

Operation

Message	Buttons	Description
Formatting the USB memory. Please wait.	-----	USB memory is being formatted. Wait for a while.
Now printing. Please wait.	-----	It is printing. Wait for a while.
Now reading data. Please wait.	-----	Information on the file and the folder is being read. Wait for a while.
Now processing NBDP settings. Please wait.	-----	The NBDP setting information is now being read or saved. Wait for a while.
Now saving data. Please wait.	-----	It is saving a file. Wait for a while.
Really quit without saving?	Yes/ No	Is it OK to quit without saving? Yes: Quits immediately No: Returns to the editor.
Replace the string?	Yes/ No	Continue to replace the strings specified? Yes: Replacing. No: Cancels this operation.
String not found.	OK	The data terminal cannot find the string searching.
The USB drive is installed and ready to use.	OK	Recognized the USB memory.
The USB memory can now be safely removed from the DTE.	OK	Unmounting the USB drive was completed.
The USB memory format complete.	OK	The format of USB memory was completed.
There are no data to be restored.	OK	There are no data to be restored and Undo is invalid.
To stop the USB drive, choose Yes. After the USB drive is stopped, the USB drive can be safely removed.	Yes/ No	Select Yes when you unmount the USB drive. After unmounting, USB memory can be removed.
Waiting for the tuner answer...	-----	Now waiting for the answer from the antenna tuner. Just a moment, please.
Warning The USB memory was removed without unmounting that drive.	OK	Removing the USB memory without unmounting may cause the malfunction of the USB memory.

5. SETTINGS & REGISTRATIONS

This chapter describes the procedures for settings and registrations such as manual date and time settings, registration of channels in each mode, advanced DSC settings, printer settings, and other settings for the equipment.

5.1 Date and time settings

Normally, the date and time are updated automatically if importing GPS information. But, if necessary, input these parameters manually as follows.

⚠ CAUTION



The time in the 7.1 Date & time menu means the present time, and is different from the time in the 7.2 POS/TIME menu that means the time when the position information is valid.

■ Procedure ■

1. Press the **MENU** key, and through hierarchical menus, select 7.1 Date & time.

```
7.1)Date & time
1. Date :2011-12-30
2. Present time :23:59
3. Display form
  - UTC/LT :UTC
  - LT diff : :
0. Back
```

2. To input the date, press ENT.
Input the year, month, and date with the numeric keypad or jog dial, and press ENT.

```
7.1)Date & time
1. Date :2012-12-30
2. Present time :23:59
3. Display form
  - UTC/LT :UTC
  - LT diff : :
0. Back
```

3. After completing the above steps, the cursor moves to 2. Present time.

```
7.1)Date & time
1. Date :2012-12-31
2. Present time :23:59
3. Display form
  - UTC/LT :UTC
  - LT diff : :
0. Back
```

Settings & Registrations

4 To input the present time, press ENT.

- Input the hours and minutes with the numeric keypad or jog dial, and press ENT.
- To close this menu after completing the date and time settings, place the cursor on any one of the selectable items and press the **CANCEL** key.

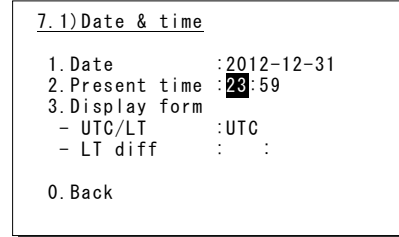

Note

In addition to the above, the following items can be set in this menu.

- UTC/LT: Select a type of time, Universal Time Coordinated (UTC) or Local Time (LT), shown on the screen.
- LT diff: Set the local time difference to display the local time.

5.2 Own ship position and time settings

Normally, the ship's position and the time are updated automatically if importing GPS information. But, if necessary, input these parameters manually as follows.

⚠ CAUTION



The time in the 7.2 POS/TIME menu means the time when the position information is valid, and is different from the present time mentioned in the 7.1 Date & time menu.

■ Procedure ■

1. Press the **MENU** key, and through hierarchical menus, select 7.2 POS/TIME.
2. To input your own ship's position, press ENT.
Select the position quadrant with the jog dial, and press ENT. Then input the latitude and longitude with the numeric keypad or jog dial, and press ENT.
3. When completing the input of the ship's position, the cursor moves to the time column of the 2. UTC of position.
 - Input the hours and minutes with the numeric keypad or jog dial, and press ENT.
 - Just after inputting the position, the present time is input to this column automatically.
 - To close this menu after completing the setting, press the **CANCEL** key.

```

7.2) POS/TIME
1. Own position: NE
                  89° 59.1234' N
                  179° 59.1234' E
2. UTC of position:
                  23:59
0. Back
  
```

```

7.2) POS/TIME
1. Own position: NE
                  89° 59.1234' N
                  179° 59.1234' E
2. UTC of position:
                  23:59
0. Back
  
```

```

7.2) POS/TIME
1. Own position: NE
                  89° 59.1234' N
                  179° 59.1234' E
2. UTC of position:
                  23:59
0. Back
  
```

Note

- After the position and the time information are input manually, that information is not overwritten with an external device, such as a GPS, automatically.
- If using the GPS information after manually inputting data, set the quadrant field mentioned above to "GPS".
- If the position and the time information are not received, from a GPS or other device within 10 minutes after powering on, or after 10 minutes has elapsed since the external input was interrupted, the alarm screen may appear. Further, regardless of either manual or automatic input, if the position and the time are not updated within 4 hours since the last entry, the alarm screen also appears.

5.3 Controller settings

The following describes the procedure regarding individual settings for the controller such as LCD adjustment.

5.3.1 LCD adjustment

The LCD conditions for viewability are adjustable as follows.

■ Procedure ■

1. Press the **MENU** key, and through hierarchical menus, select 7.3.1 LCD adjustment.

The screen as shown at right is displayed.

```

7.3.1) LCD adjustment
1. Contrast : 06
2. Dimmer
   Maximum : 10
   Typical  : 08
   Minimum  : 06
3. Screen saver : OFF
   Timer(sec) : 060
0. Back
    
```

2. Move the cursor to the desired item and press ENT. Then alter the settings as appropriate with the numeric keypad or jog dial, and press ENT again.

- Set each item within the ranges given below:

- Contrast: 1 - 11
- Dimmer: 1 - 10
- Screen saver: ON/OFF
- Timer: 1 - 999 seconds

- To close this menu, place the cursor on any one of the selectable items and press the **CANCEL** key.

```

7.3.1) LCD adjustment
1. Contrast : 06
2. Dimmer
   Maximum : 10
   Typical  : 08
   Minimum  : 06
3. Screen saver : OFF
   Timer(sec) : 060
0. Back
    
```

5.3.2 Sound settings

Sound settings such as the click beep are adjustable as follows.

■ Procedure ■

1. Press the **MENU** key, and through hierarchical menus, select 7.3.2 Sound.

The screen as shown at right is displayed.

```

7.3.2) Sound
1. Operation
   - Speaker : ON
   - Click   : ON
2. Notification level : 7
3. Sidetone : ON
0. Back
    
```

2. Move the cursor to the desired item and press ENT. Then set the conditions as appropriate with the numeric keypad or jog dial, and press ENT again.

- Notification level for a tone can be set within 1 - 7.
- When Sidetone is set to ON, an 800 Hz tone sounds during keying in.
- To close this menu, place the cursor on any one of the selectable items and press the **CANCEL** key.

```

7.3.2) Sound
1. Operation
   - Speaker : ON
   - Click   : ON
2. Notification level : 7
3. Sidetone : ON
0. Back
    
```

5.3.3 User key assignments

User key assignment enables the desired menu to be displayed immediately without moving through the hierarchical menus, and is assignable as follows.

■ Procedure ■

1. Press the **MENU** key, and through hierarchical menus, select 7.3.3 User key assign.

The screen at right is displayed. If the desired menu has already been registered, the cursor is placed on that menu.

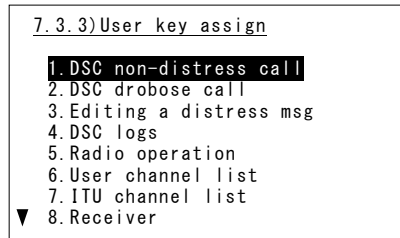

2. Move the cursor to the desired menu to be registered with the jog dial.

The assignable menus are as follows:

1. DSC non-distress call	(Menu1)	18. POS/TIME	(Menu7.2)
2. DSC drobose call	(Menu2)	19. My controller	(Menu7.3)
3. Editing a distress msg	(Menu3)	20. LCD adjustment	(Menu7.3.1)
4. DSC logs	(Menu4)	21. Sound	(Menu7.3.2)
5. Radio operation	(Menu5)	22. User channels	(Menu7.4)
6. User channel list	(Menu5.1)	23. DSC/WKR condition	(Menu7.5)
7. ITU channel list	(Menu5.2)	24. Automatic ACK	(Menu7.5.1)
8. Receiver	(Menu5.4)	25. WKR scanning FRQ	(Menu7.5.2)
9. Scan	(Menu5.4.7)	26. Option	(Menu7.6)
10. Transmitter	(Menu5.5)	27. CH dial lock ON/OFF	---
11. Maintenance	(Menu6)	28. 2182kHz	---
12. Self diagnosis	(Menu6.1)	29. AM mode	---
13. DSC loop	(Menu6.1.1)	30. DSC alarm setting	(Menu7.3.3)
14. Alarm information	(Menu6.2)	31. Group ID	(Menu7.5.6)
15. Software version	(Menu6.3)	32. Inactivity timeout	(Menu7.5.7)
16. Setup	(Menu7)	33. DSC call list	(Menu7.5.8)
17. Date & time	(Menu7.1)		

3. Press ENT to complete registration.

After registration, the screen returns to the previous hierarchical menu as shown at right.

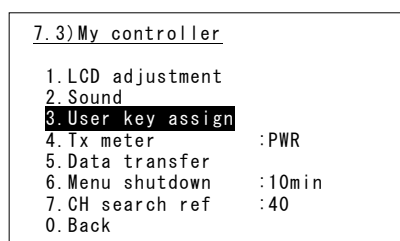

Note

When the **USER** key is pressed in the factory default setting, this menu is immediately displayed.

5.3.4 Selecting Tx meters

The meter displayed in the status display indicates the strength of the received signal (S meter). However, it can also indicate one of Tx power, antenna current, PA voltage, PA current or key information during transmission.

■ Procedure ■

1. Press the **MENU** key, and through hierarchical menus, select 7.3 My controller.

The screen as shown at right is displayed.

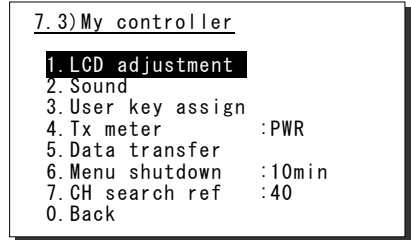

2. Move the cursor to 4. Tx meter with the numeric keypad or jog dial.

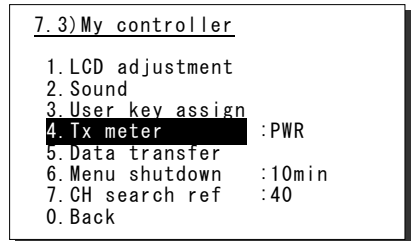

3. Press ENT, and select the meter type with the jog dial.

The selectable meters are as follows:

- PWR.... Tx power
 - Ia Antenna current
 - Vc PA voltage
 - Ic PA current
 - Key.....Key information*
- * When keying during the ARQ communication, the Key is indicated regardless of this setting.

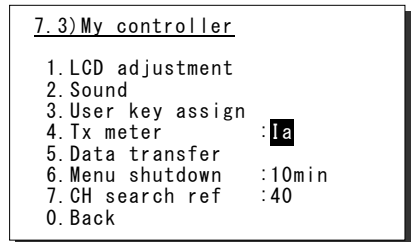

4. Press ENT to confirm the selection.

The setting is complete.

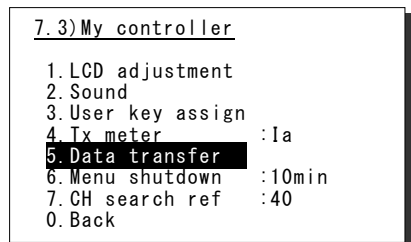

5.3.5 Transferring user channel data to another controller

When 2 controllers are connected, stored information (user channel table) can be transferred from the controller having access rights to another controller (monitor condition).

■ Procedure ■

1. Press the **MENU** key, and through hierarchical menus, select 7.3 My controller.
2. Move the cursor to 5. Data transfer with the numeric keypad or jog dial and press ENT.

The popup screen as shown at right is displayed.

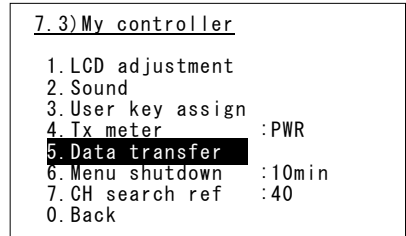

3. Press ENT to confirm the selection.

- The popup screen as shown at right is displayed to indicate the controller's status for forwarding.
- The screen at right (below) is displayed on the monitor.
If OK is selected or the screen is left as it is for 10 seconds, transferring of stored information is started.

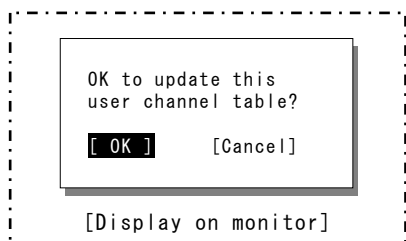
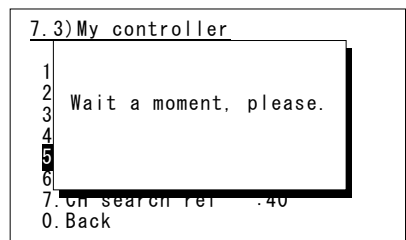
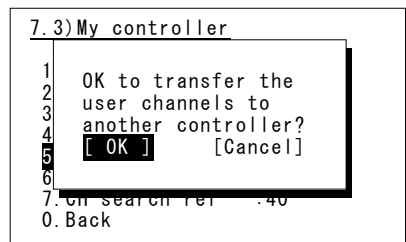

4. Forwarding of stored information is started.
- During forwarding, the popup screen as shown at right is displayed.
 - The screen at right (below) is displayed on the monitor.
 - The previous screen is returned to when forwarding is completed.

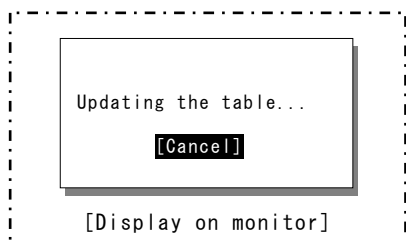
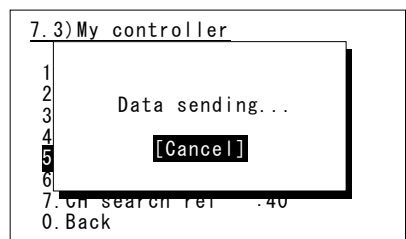

Note

To cancel forwarding midway, press the **CANCEL** key or ENT.

5.3.6 Setting the inactivity timer (for menu shutdown)

To close menus of the controller automatically which is left as opening menus, the inactivity timer can be set according to the following procedure.

■ Procedure ■

1. Press the **MENU** key, and through hierarchical menus, select 7.3 My controller.
2. Move the cursor to 6. Menu shutdown with the numeric keypad or jog dial, and press ENT.

```

7.3) My controller
1. LCD adjustment
2. Sound
3. User key assign
4. Tx meter : PWR
5. Data transfer
6. Menu shutdown : 10min
7. CH search ref : 40
0. Back
    
```

3. Input the timer value and press ENT.
 - The range is from 00 to 60 minutes.
 - To set this timer to OFF, input 00. In this case, the screen shows OFF as shown at right.

```

7.3) My controller
1. LCD adjustment
2. Sound
3. User key assign
4. Tx meter : PWR
5. Data transfer
6. Menu shutdown : OFF
7. CH search ref : 40
0. Back
    
```

5.3.7 Setting the reference value for the channel auto search

When making a DSC routine call, the controller searches the working channel (frequency) automatically by checking the every channel busy referring the signal level with the value set as follows.

■ Procedure ■

1. Press the **MENU** key, and through hierarchical menus, select 7.3 My controller.
2. Move the cursor to 7. CH search ref with the numeric keypad or jog dial, and press ENT.

```

7.3) My controller
1. LCD adjustment
2. Sound
3. User key assign
4. Tx meter : PWR
5. Data transfer
6. Menu shutdown : 10min
7. CH search ref : 40
0. Back
    
```

3. Input the reference value and press ENT.

The range is from 00 to 50.

```

7.3) My controller
1. LCD adjustment
2. Sound
3. User key assign
4. Tx meter : PWR
5. Data transfer
6. Menu shutdown : OFF
7. CH search ref : 45
0. Back
    
```

5.4 Registering user channels

Often used frequencies at the controller for the radiotelephone, CW, and DSC mode can be registered as user channels and used in scanning radio settings or groups. A total of 20 groups with 20 channels set to each group (i.e. 400 channels) can be registered. Furthermore, the user channels of the telex frequency can be registered to the station list of the data terminal.

■ Procedure ■

1. Press the **MENU** key, and through hierarchical menus, select 7.4 User channels (index).

7.4) User channels (index)		
No	CH group name	Type
01	JRC Tokyo	TEL
02	Pacific ABC	CW
03		
04		
05		
06		
07		
▼08		

2. Select the desired row or group to be edited with the numeric keypad or jog dial.

The screen at right is displayed. (This example is for new registration to group 03.) Also, if an unregistered group is opened, TEL is displayed at Type as the default.

7.4) User channels (table)			
Name:			
Type: TEL			
CHNo	Rx [kHz]	Tx [kHz]	Mode
041			
042			
043			
044			
045			
▼046			

3. Press ENT to enter the group name.

- Up to 18 characters can be registered.
- The following characters are available:
 - Alphabet (capital and small letters)
 - Numbers 0 - 9
 - The following signs, space and determination symbol (◀)
- Group names can be omitted.

7.4) User channels (table)			
Name: ◀			
Type: TEL			
CHNo	Rx [kHz]	Tx [kHz]	Mode
041			
042			
043			
044			
045			
▼046			

4. Select a character and press ENT one by one.

- When inputting numbers with the numeric keypad ENT is not needed.
- To return to the previous letter, press the **CANCEL** key.
- To complete name entry of 18 characters long, press ENT after selecting the last character by the jog dial. Or, if the name is less than 18 characters long, following the name, select the determination symbol (◀), as shown at right and press ENT.

7.4) User channels (table)			
Name: Japan Radio◀			
Type: TEL			
CHNo	Rx [kHz]	Tx [kHz]	Mode
041			
042			
043			
044			
045			
▼046			

Note

The character sequence shown by turning the jog dial is as follows:

◀ A B C D E F G H I J K L M N O P Q R S T U V W X Y Z a b c d e f g h i j k l m n
o p q r s t u v w x y z [] _ " # % & ' () ? @ + - / = : ; < > 0 1 2 3 4 5 6 7 8 9 (space)

Settings & Registrations

5. After completing the above steps, the cursor returns to Type.

- If necessary, change the group attribute (communication mode or custom).
- The following attributes can be selected:
 - TEL Radiotelephone mode
 - DSC Digital selective calling mode
 - CW Continuous wave mode
 - Custom Communication mode mix

7.4)User channels (table)			
Name: Japan Radio			
Type: TEL			
CHNo	Rx [kHz]	Tx [kHz]	Mode
041			
042			
043			
044			
045			
▼ 046			

6. When setting of group attributes is completed, the cursor returns to the topmost row of the channel number. (CHNo).

7.4)User channels (table)			
Name: Japan Radio			
Type: TEL			
CHNo	Rx [kHz]	Tx [kHz]	Mode
041			
042			
043			
044			
045			
▼ 046			

7. Select the channel number to register with the jog dial, and press ENT.

Register as follows in the popup screen at right.

- When the group attribute is Custom, specify the communication mode at Mode. Otherwise, the communication mode is fixed to the mode specified at Type.
- To reference a frequency from the ITU channel, move the cursor to ITU channel, press ENT, and specify that channel number.
- Move the cursor to Rx freq(kHz), press ENT, and enter the Rx frequency.
- Move the cursor to Tx freq(kHz), press ENT, and enter the Tx frequency.

7.4)User channels (table)			
Name: CHNo. 041/Type TEL			
Type: Mode : TEL			
CHNo	ITU Channel	Mode	
041	Rx freq(kHz) :		
041	Tx freq(kHz) :		
041	[OK] [Cancel] [Erase]		
044			
045			
▼ 046			

8. After completing the above steps, move the cursor to OK, and press ENT to complete registration.

- Follow the same procedure above to create a group of channels.
- Already registered channels can be changed by the above procedure.
- To close this menu, place the cursor on any one of the registration numbers, and press the **CANCEL** key.

7.4)User channels (table)			
Name: Japan Radio			
Type: TEL			
CHNo	Rx [kHz]	Tx [kHz]	Mode
041	4071.0	4071.0	TEL
042			
043			
044			
045			
▼ 046			

Note

- To delete an already registered channel, move the cursor to Erase in the above popup screen, and press ENT.
- To erase an already registered group, move the cursor to "000 ALL CLEAR function" in the bottommost row of the channel list, and press ENT. Next, move the cursor to OK in the confirmation screen, and press ENT.
- To erase all already registered groups, move the cursor to "00 ALL CLEAR function" in the User channels (index) screen, and press ENT. Next, move the cursor to OK in the confirmation screen, and press ENT.
- When the 7.6.1 Connection is set to DTE, the group 20 becomes the reserved group for telex channels of the data terminal and inaccessible at the controller.

5.5 Advanced settings for DSC/WKR

The following describes the procedure for the advanced DSC settings such as automatic acknowledgement, as well as setting the watch frequency of the watch keeping receiver.

■ Menu screen ■

Press the **MENU** key, and through hierarchical menus, select 7.5 DSC/WKR condition.

The following describes the procedures from this screen. Note that the screen at right shows factory default settings.

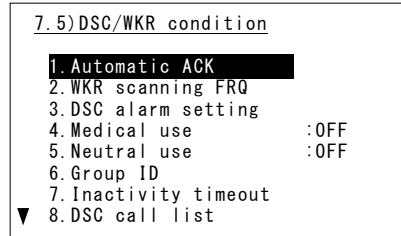

5.5.1 Automatic acknowledgement

While the automatic acknowledgement is set to ON, and no menu is displayed and there is no active procedure, if either one of the individual calls below is received, the acknowledgement is sent automatically.

- Safety test call
 - Safety position request call
 - Routine polling call
 - Individual call requesting communication without valid frequency (*)
- (*) In this case, the “unable to comply” acknowledgement is sent.

■ Procedure ■

1. Move the cursor to 1. Automatic ACK, and press ENT.

The screen as shown at right is displayed.

2. Set the call setting targeted for automatic acknowledgement to ON.

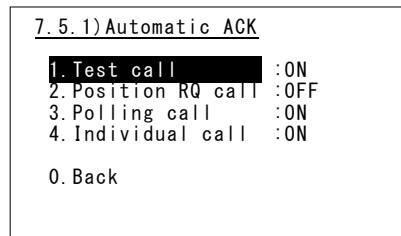

5.5.2 Setting DSC watch frequency

Set the frequency to watch on the WKR (DSC watch keeping receiver).

■ Procedure ■

1. Move the cursor to 2. WKR scanning FRQ, and press ENT.

The screen as shown at right is displayed.

2. Press ENT, and set another frequency in addition to 2187.5 kHz and 8414.5 kHz to ON.

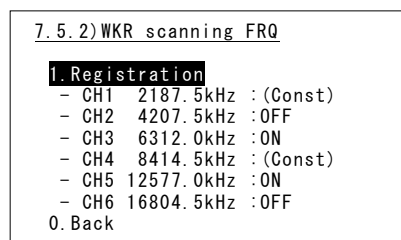

Note

In accordance with the SOLAS Convention, 2187.5 kHz and 8414.5 kHz cannot be turned OFF.

5.5.3 Setting receiving alarms

The DSC receiving alarm can be set as follows.

■ Procedure ■

Move the cursor to 3. DSC alarm setting, and press ENT.

The screen as shown at right is displayed. Change the settings as appropriate.

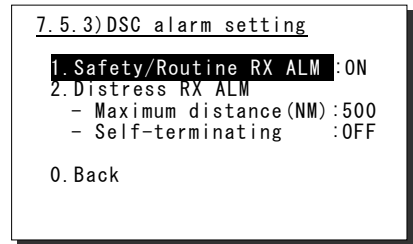

- To disable the receiving alarms for routine and safety calls, set 1. Safety/Routine RX ALM to OFF.
 - The receiving alarms condition of distress alerts or distress relay calls can be changed using the menu 2. Distress RX ALM as follows.
 - Normally when receiving a new distress event, the receiving alarm has to be stopped manually. However if the ship in distress is located within 70 degree north and 70 degree south latitude, and farther than the Maximum distance value while the Self-terminating set is ON, the alarm is treated as the self-terminating alarm.
 - The Maximum distance can be set within the range of 500 to 999 NM.
- Note1) If making this value valid, always set the Self-terminating to ON.
 Note2) If receiving DSC messages from the ships located out of range, the messages are handled normally except the alarm sound.

5.5.4 Using medical/neutral settings for urgency calls

Set the condition so that an urgency area call containing the additional subject of either "Medical transportation" or "Neutral nationality" can be sent. It is useful for the situation when sailing dangerous waters such as in areas of political instability, and needed to inform receivers of the additional information if any of the following apply.

- Own ship is performing medical transportation and protected under the 1949 Geneva Convention.
 - Own ship is of neutral nationality in accordance with ITU resolution 18 (Mob-83).
- Additionally note that this setting is returned to the default (OFF) if the power is turned off.

■ Procedure ■

To use these kinds of calls, set 4. Medical use or 5. Neutral use condition to ON.

5.5.5 Registering the ship's group ID

Register the group ID (group ship ID number) for receiving group calls.

■ Procedure ■

1. Move the cursor to 6. Group ID, and press ENT.

The screen as shown at right is displayed.

2. Move the cursor to register the ID number and press ENT, then input the 9 digits ID (leftmost digit fixed to 0).

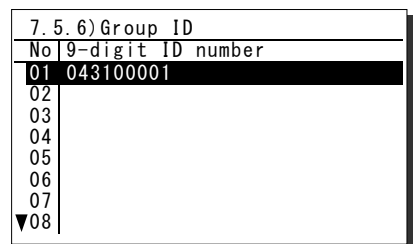

- Upto 20 groups can be registered.
- When finished, press **CANCEL** key.

5.5.6 Setting the inactivity timer (for procedures on hold)

When making a procedure on hold, the procedure is automatically terminated after the time set as follows.

■ Procedure ■

1. Move the cursor to 7. Inactivity timeout, and press ENT.

The screen as shown at right is displayed.
Change the settings as appropriate.

1. ACKed distress alert
The acknowledged distress alert events sent from the own ship:
- The range is 00 (OFF) to 60 minutes.
2. RCVDed other distress
The distress events of other ships
- The range is 00 (OFF) to 60 minutes.
3. Non-distress call
Routine, safety and urgency events
- The range is 00 (OFF) to 60 minutes.
4. Other communications
Communications without using DSC
- The range is 010 to 600 seconds.

7. 5. 7) Inactivity timeout	
1. ACKed distress alert:	OFF
2. RCVDed other distress:	OFF
3. Non-distress call :	15min
4. Other communications:	030sec
0. Back	

5.5.7 Registering the DSC call list

To call the station using the DSC, registers the station names, MMSI and the calling frequencies as follows.

■ Procedure ■

1. Move the cursor to 8. DSC call list, and press ENT.

The screen as shown at right is displayed.

7. 5. 8) DSC call list		
No	Station name	MMSI
01	JRC Mitaka1	431000001
02		
03		
04		
05		
06		
07		
▼08		

2. Move the cursor to the line to be changed and press ENT to display the frequency list as shown at right.

7. 5. 8) DSC call list (FRQ)			
Name: JRC Mitaka1			
MMSI: 431000001			
No	Rx [kHz]	Tx [kHz]	Category
01	2177.0	2189.5	RTN
02	4219.5	4208.0	RTN
03	4220.0	4208.5	RTN
04	4220.5	4209.0	RTN
05			
▼06			

3. Input data as appropriate using the numeric keypad or jog dial.
 - Upto 20 channels for every 20 stations can be registered.
 - When finished, press **CANCEL** key.

5.6 Setting connections for options

When setting connections between the controller and optional devices, such as a printer, configure the conditions as appropriate according to the device type, as follows.

■ Procedure ■

1. Press the **MENU** key, and through hierarchical menus, select 7.6 Option.

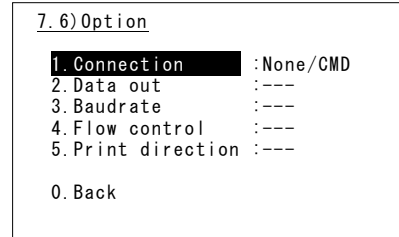

2. Move the cursor to the desired item, and press ENT.

Move the cursor to the right. Then select the condition as appropriate and press ENT.

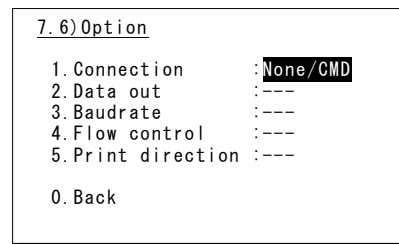

Note

- The content and the selectable conditions of each item are as follows.

Item Name	Content	Selectable conditions (■ : Factory default)
Connection	Connection status and printer type	None/CMD/ Serial PRN / NKG-800 / DTE
Data out	Printing method for DSC messages	■/ Auto/ Manual
Baudrate	Transmission speed to printer	■/ 4.8k/ 9.6k/ 38.4k/ 57.6kbps
Flow control	Handshake setting with printer	■/ None/ Hard
Print direction	Printing sequence of lines	■/ Upright/ Invert

- When connecting a serial printer (e.g. NKG-91), set the items as follows:
 - 1.Connection :Serial PRN
 - 2.Data out :Auto
 - 3.Baudrate :4.8k
 - 4.Flow control :Hard
 - 5.Print direction :Invert (NKG-91)/Upright (DPU-414)
- When connecting the NKG-800/900 printer, set the items as follows:
 - 1.Connection :NKG-800
 - 2.Data out :Auto
- If no option is connected, select None/CMD at the Connection.
 Note) When None/CMD is set, connect nothing to the serial port.
- When connecting the data terminal to the controller for the telex communication, set Connection item to DTE. Note that restart the system just after this setting. Moreover, Baudrate, Flow control and Print direction become unchangeable in this case.

5.7 Setting of data terminal

The following describes the procedure regarding LCD adjustment, such as the color settings and brightness, and registration of the station list.

5.7.1 LCD adjustment

■ Procedure ■

1. If displaying the message of "Press Enter key to get the access right in the NBDP mode..." on the data terminal, press Enter key on the keyboard.

The operation of the data terminal becomes possible in the telex mode, except when the controller is used.

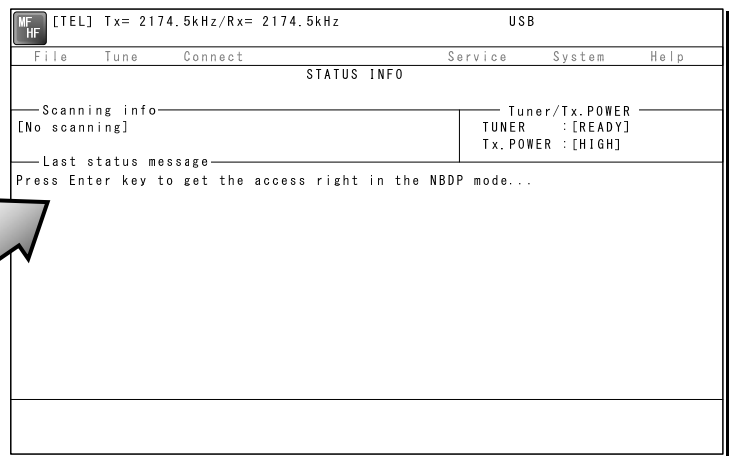

2. On the main menu and the dropdown menu, select System → Config with Enter key.

The setting conditions concerning to the screen are displayed.

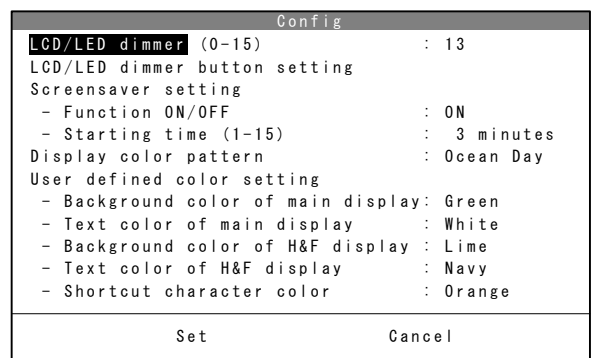

3. Select the item to be changed by the cursor and press Enter key, then input the appropriate condition.

Set the item using the numeric keypad or dropdown menu, where the cursor moves to the right as shown at right. As for other items, the specific menu is displayed.

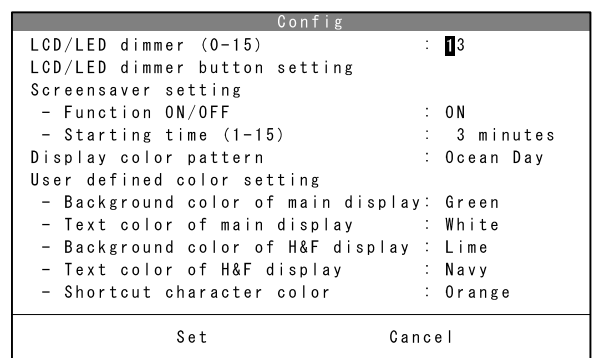

4 When completing the setting, move the cursor to the Set and press Enter key.

Note

The content of each setting item is as follows.

Item	Content of setting	Remarks
LCD/LED dimmer (0-15)	Adjusts the brightness of the LCD and the panel lamp by 16 steps.	Without using this menu, the dimmer is adjustable with Ctrl+↑ or Ctrl+↓ operation.
LCD/LED dimmer button setting	Sets the brightness of the LCD and the panel lamp when using the DIM key on the panel.	
Screensaver setting - Function ON/OFF	Sets the screen saver ON/OFF.	
- Starting time (1-15)	Sets the time until the screensaver starts.	The screensaver is invalid at the following cases; <ul style="list-style-type: none"> communicating in the telex mode, running self-diagnosis.
Display color pattern	Sets the color of the screen from the following 9 patterns of the dropdown list. <ul style="list-style-type: none"> Ocean Day/ Dusk/ Night Earth Day/ Dusk/ Night Basic Black/ White User defined 	
User defined color setting - Background color of main display	Sets the background color of the main screen from the following. Black/ Gray/ Silver/ White/ Maroon/ Red/ Olive/ Yellow/ Green/ Lime/ Teal/ Cyan/ Navy/ Blue/ Purple/ Magenta/ Orange	<ul style="list-style-type: none"> This menu is valid only when Display color pattern = User defined. Setting the same color with the main screen or the short cut character is inhibited.
- Text color of main display	Sets the text color of the main screen from the following. Black/ Gray/ Silver/ White/ Maroon/ Red/ Olive/ Yellow/ Green/ Lime/ Teal/ Cyan/ Navy/ Blue/ Purple/ Magenta/ Orange	<ul style="list-style-type: none"> This menu is valid only when Display color pattern = User defined. Setting the same color with the background of the main screen is inhibited.
- Background color of H&F display	Sets the background color of the header/footer screen from the following. Black/ Gray/ Silver/ White/ Maroon/ Red/ Olive/ Yellow/ Green/ Lime/ Teal/ Cyan/ Navy/ Blue/ Purple/ Magenta/ Orange	<ul style="list-style-type: none"> This menu is valid only when Display color pattern = User defined. Setting the same color with the text of the header/footer screen is inhibited.
- Text color of H&F display	Sets the text color of the header/footer screen from the following. Black/ Gray/ Silver/ White/ Maroon/ Red/ Olive/ Yellow/ Green/ Lime/ Teal/ Cyan/ Navy/ Blue/ Purple/ Magenta/ Orange	<ul style="list-style-type: none"> This menu is valid only when Display color pattern = User defined. Setting the same color with the background of the header/footer screen is inhibited.
- Shortcut character color	Sets the shortcut character color from the following. Black/ Gray/ Silver/ White/ Maroon/ Red/ Olive/ Yellow/ Green/ Lime/ Teal/ Cyan/ Navy/ Blue/ Purple/ Magenta/ Orange	<ul style="list-style-type: none"> This menu is valid only when Display color pattern = User defined. Setting the same color with the background of the main screen is inhibited.

5.7.2 Registering station list

■ Procedure ■

1. If displaying the message of "Press Enter key to get the access right in the NBDP mode..." on the data terminal, press Enter key on the keyboard.

The operation of the data terminal becomes possible in the telex mode, except when the controller is used.

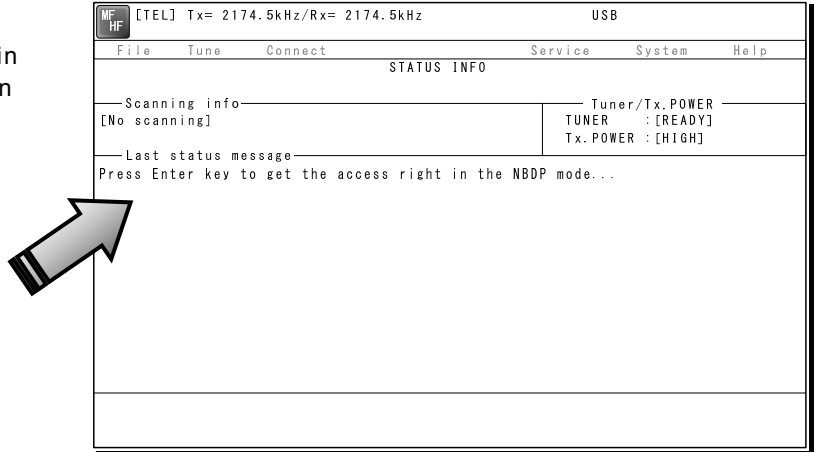

2. On the main menu and the dropdown menu, select Service → Station list with Enter key.

The station list is displayed.

Station list					
No.	Station Name	ID	Location	F. Sig	
1	Station 01	004310123	N33°45' E138°12'	DOTDOT	[Edit]
2	Station 02	004311234	N37°22' E135°51'	DOTDOT	[Erase]
3	Station 03	431012345			[Print]
4					[Cancel]
5					
6					
7					
8					
9					
10					

3. Select the line to be registered newly or to be changed with the cursor and press Enter key. Then input the station information including the channels on the station list edit screen.

- Input the radio station name within 16 characters to Station Name column. (The @ character is unavailable.)
- Input 4 (coast station), 5 (ships station) or 9 digits SELCAL number to Station ID column.
- The Location and Free CH Sig are optional.
- Move the cursor to the line to be registered and press Enter key. Then input the Tx/Rx frequencies on the popup screen at right.

Station list edit					
Station Name : [Station 01]		Station ID : [004310123]			
Location : [N33°45' E138°12']		Free CH Sig : [DOTDOT]			
No.	Tx.F	Rx.F	No.	Tx.F	Rx.F
1	4202.5	4202.5	11	22354.5	22354.5
2	4205.0	4205.0	12	25193.0	25193.0
3	6300.5	6300.5	13	25208.0	25208.0
4	6303.0	6303.5	14		
5	8396.5	8396.5	15		
6	8399.0	8399.0	16		
7	12560.0	12560.0	17		
8	16785.0	16785.0	18		
9	18893.0	18893.0	19		
10	22352.0	22352.0	20		

Tx/Rx frequency set	
Tx frequency :	[.] kHz
Rx frequency :	[.] kHz
Set	Cancel

4. After inputting, press Enter key to close the screen and finish the registration.

Note

There is the station database menu (Service → Station database) as a similar registration menu to register the station information. The station database operation is basically the same with the station list. However note that the station list is designed for the manual input only, but the station database is designed to register the station information more easily such as copying the original station database prepared in advance. The functions available on the station database screen are as follows.

- Program Registers the station information located with the cursor to the desired line of the station list.
- Read Reads the station database saved in the flash ROM or the USB memory.
- Write Saves the prepared station database in another drive or the folder.
- Get Loads station information of the station list on a line of the station database.

5.8 Setting telex mode

The following describes the procedure to check or set the condition for the telex communication.

■ Procedure ■

1. If displaying the message of "Press Enter key to get the access right in the NBDP mode..." on the data terminal, press Enter key on the keyboard.

The operation of the data terminal becomes possible in the telex mode, except when the controller is used.

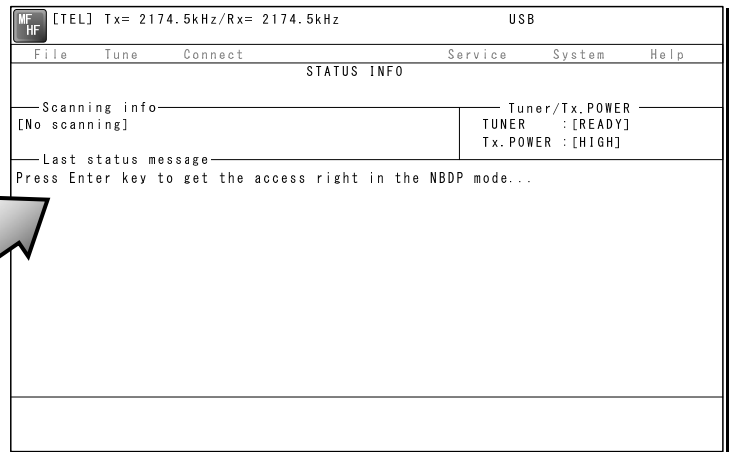

2. On the main menu and the dropdown menu, select System → NBDP setup with Enter key.

The setting conditions concerning to the telex communication are displayed.

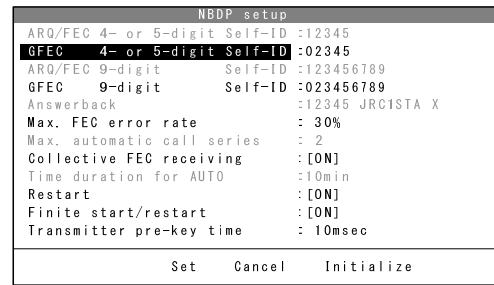

3. Select the item to be changed with the cursor, and press Enter key.

The input screen as shown at right is displayed.

※ An example of Max. FEC error rate

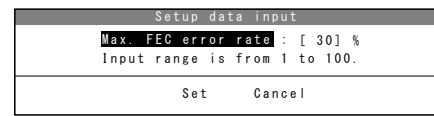

4. Press Enter key to move the cursor to the right. Then input the value and press Enter key again.

The cursor moves to Set.

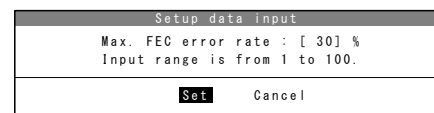

Settings & Registrations

5. When the cursor is located on Set, press Enter key to set the value and close the popup screen.
6. After completing the every input, move the cursor to Set and press Enter key to save and finish the registration.

Note

- When selecting the Initialize with the cursor and pressing Enter key, the every accessible item is reset to the factory default setting.
- The content of each item and the factory default setting values are as follows.

Item	Setting contents	Initial value	Remarks
ARQ/FEC 4- or 5-digit Self-ID	Registers the SELCAL number. ※ 4-digit is for the coast station.	----	When setting this item, contact our company or agency.
GFEC 4- or 5-digit Self-ID	Registers the group ID. ※ 4-digit is for the coast station	----	
ARQ/FEC 9-digit Self-ID	9-digit SELCAL number for reference.	----	Common with the DSC
GFEC 9-digit Self-ID	Registers the 9-digit group ID.	----	
Answerback	Registers the answerback code used with WRU and Hereis.	----	When setting this item, contact our company or agency.
Max. FEC error rate	Sets the permissible error rate that occurs during CFEC receiving.	30 %	
Max. automatic call series	Sets times to retry calling a station if failed to call the station using the CALL function.	2	Optional
Collective FEC receiving	Sets ON/OFF of the CFEC or SFEC receiving.	ON	
Time duration for AUTO	Sets the interval time until retrying if failed to call a coast station using the AUTOTELEX function.	10 min	Optional
Restart	Sets ON/OFF of the rephasing function if disconnected the communication in ARQ mode.	ON	
Finite start/restart	Sets ON/OFF of the limit of the ARQ call times, which is 128 times for phasing and 32 times for rephasing.	ON	
Transmitter pre-key time	Sets a period between key on and starting the signal output.	10 ms	

6. MAINTENANCE & INSPECTION

The performance and lifetime of the equipment depend on appropriate maintenance. This chapter describes an outline of maintenance and inspection, self diagnosis and troubleshooting.

6.1 General maintenance & inspection

In order to operate the equipment under optimum conditions, it is vital to perform regular inspections and also, to keep accurate records. Inspections enable problems to be identified before they become major malfunctions. The following inspections should be made regularly.

Inspection sequence	Inspection item	Procedure
1	Antenna system	Check that antennas and the connectors are secure.
2	RF GAIN function	In the radiotelephone mode (TEL), turn the RF GAIN control on the controller having access rights. Is the radio static (noise) from the speaker adjustable?
3	Receiver condition check by speaker output	Check that the voice level and noise level are not abnormally loud or soft.
4	Handset PTT switch	In the radiotelephone (TEL) mode, press the PTT switch, and check that the unit transmits immediately on the Tx meter or by TX and ON displayed on the screen.
5	Transmission and reception check by performing radio communication	In the radiotelephone (TEL) mode, check that normal conversation is possible.
6	Condition of the data terminal	When the communication mode is other than the telex mode (e.g. TEL mode), check that the communication mode can be set to the telex mode by pressing the Enter key on the keyboard of the data terminal.
7	Air filter	Check that whether the air filter of the battery charger is clogged with dust.

6.2 Self diagnosis inspection

The following describes the procedure for performing self diagnosis in the 6.1 Self diagnosis menu.

■ Procedure ■

1. Press **FUNC** → **8_{TEST}**.

The 6.1 Self diagnosis menu is displayed.

```
6.1)Self diagnosis
1. Transceiver
2. Controller/DTE
3. Transceiver log
4. Controller/DTE log
5. DSC/NBDP loop
6. Printout :Valid
0. Back
```

2. Select Transceiver, Controller/DTE, or DSC/NBDP loop.

- When Transceiver is selected, the screen at right is displayed.
- For DSC/NBDP loop, a shortcut menu for diagnosing the modem is as shown in the screen at right.

```
6.1.1) Transceiver
Target :ALL
- ATU -
1. Serial I/F :
2. Band1-Input :
3. Band1-Tune :
4. Band2-Input :
5. Band2-Tune :
6. Band3-Input :
7. Band3-Tune :
```

3. In the above screen, press ENT, select the diagnosis mode with the jog dial, and press ENT. Self diagnosis is performed.

The following test modes are available:

6.1.1) Transceiver ... ALL (all modes)

```
TRX&MODEM
PA&ATU
WKR MODEM
TRX
PA
ATU
```

6.1.2) Controller..... ALL (all modes)

```
DGT CKT
AF output
LCD&LED
Speaker
Printer
DTE
```

```
6.1.1) Transceiver
Target :TRX&MODEM
- ATU -
1. Serial I/F :
2. Band1-Input :
3. Band1-Tune :
4. Band2-Input :
5. Band2-Tune :
6. Band3-Input :
7. Band3-Tune :
```

```
6.1.1) Transceiver
Target :ATU
- ATU -
1. Serial I/F :OK
2. Band1-Input :Checking
3. Band1-Tune :
4. Band2-Input :
5. Band2-Tune :
6. Band3-Input :
7. Band3-Tune :
```

Note

- If the jog dial is turned while the cursor is at Target when Transceiver is selected, the diagnosis items of each unit and previous diagnosis results can be browsed.
- To cancel self diagnosis midway, press the **CANCEL** key.
- The results of the self diagnosis are stored as a log, and up to 10 logs can be confirmed from the 6.1.3 Transceiver log or 6.1.4 Controller/DTE log menu.
- The self diagnosis results are printed out to the connected printer. Additionally, the state can be set with the menu 6. Printout as follows;
Valid: Target & result of the every item, Simple: Target & the result, and Invalid
- The self diagnosis test contents and results are as shown below.

Unit Name	Test Item	Contents	Results
Transceiver	ATU	<ul style="list-style-type: none"> • Serial I/F :Serial communication • Band1-Input :2140 kHz input value • Band1-Tune :2140 kHz tuning operation • Band2-Input :4149 kHz input value • Band2-Tune :4149 kHz tuning operation • Band3-Input :6230 kHz input value • Band3-Tune :6230 kHz tuning operation • Band4-Input :8297 kHz input value • Band4-Tune :8297 kHz tuning operation • Band5-Input :16546 kHz input value • Band5-Tune :16546 kHz tuning operation • Band6-Input :25118 kHz input value • Band6-Tune :25118 kHz tuning operation 	OK: Normal NG: Abnormal
	PA	<ul style="list-style-type: none"> • PA mute port :Confirmation of PA diagnosis viability • RBK port :RBK overcurrent detection • Memory1 :EEPROM1 operation • Memory2 :EEPROM2 operation • Band1-Output :2140 kHz output • Band2-Output :4149 kHz output • Band3-Output :6230 kHz output • Band4-Output :8297 kHz output • Band5-Output :16546 kHz output • Band6-Output :25118 kHz output • Input voltage :Input signal from TRX 	OK: Normal NG: Abnormal
	TRX	<ul style="list-style-type: none"> • Memory :EEPROM operation • Digital CKT :FPGA operation • BK port :BK signal state • PLL lock :State of PLL for DDS/DUC clock • Band1-TX output :1600 kHz output • Band2-TX output :22000 kHz output • Band3-TX output :27500 kHz output • Band4-TX output :RX diagnosis circuit • Band1-RX BPF1 :1600 kHz Rx level • Band2-RX BPF2 :390 kHz Rx level • Band3-RX BPF3 :1590 kHz Rx level • Band4-RX BPF4 :3190 kHz Rx level • Band5-RX BPF5 :6090 kHz Rx level • Band6-RX BPF6 :10490 kHz Rx level • Band7-RX BPF7 :17990 kHz Rx level • Band8-RX BPF8 :27500 kHz Rx level 	OK: Normal NG: Abnormal
	WKR MODEM	<ul style="list-style-type: none"> • Memory1 :FROM operation • Memory2 :EEPROM operation • Memory3 :SDRAM operation • PLL lock :State of PLL for DDS clock • Band1-RX BPF1 :2187.5 kHz DSC loop • Band2-RX BPF2 :4207.5 kHz DSC loop • Band3-RX BPF3 :6312.0 kHz DSC loop • Band4-RX BPF4 :8414.5 kHz DSC loop • Band5-RX BPF5 :12577.0 kHz DSC loop • Band6-RX BPF6 :16804.5 kHz DSC loop • Band7-RX BPF7 :Wide-band filter operation • DSC/NBDP Loop1 :AF modem loop • DSC/NBDP Loop2 :AF modem & TRX loop 	OK: Normal NG: Abnormal

Maintenance & Inspection

Unit Name	Test Item	Contents	Results
Controller/Data terminal	DGT CKT	<ul style="list-style-type: none"> • Memory1 :FROM operation • Memory2 :EEPROM operation • Memory3 :SDRAM operation 	OK: Normal NG: Abnormal
	AF output	AF connection to TRX	OK: Normal NG: Abnormal
	LCD&LED	Screen and ALM lamp display operation Note: Check visually if every dot and red and green ALM lamp alternately work normally for 3 seconds.	DONE
	Speaker	Sound test Note: Check if the 1500 Hz tone sounds correctly. After that, press ENT on the popup screen to finish this process.	DONE
	Printer	Print out test Note: When the printer is connected, check the print result in the printed data output.	DONE
	DTE	<ul style="list-style-type: none"> • DTE memory1 :FROM operation • DTE memory2 :SDRAM operation 	OK: Normal NG: Abnormal
		<ul style="list-style-type: none"> • DTE LCD&LED :Data terminal screen and lamp operation Note: Check visually if every dot alternating colors of red, green, blue and white with the lamp blink work normally for 5 seconds.	DONE
		<ul style="list-style-type: none"> • DTE buzzer :DTE buzzer operation Note: Check if the buzzer sounds correctly. After 3 seconds, sounding stops automatically	DONE

6.3 System alarm indication

This equipment displays alarms as follows when an internal or external error is detected.

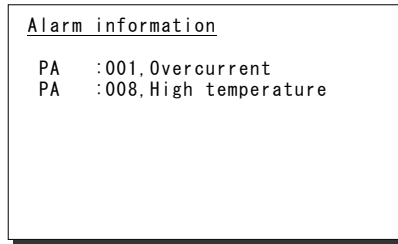

Note

- To return to the previous screen after the alarm is displayed, press the **CANCEL** key.
- When the TRX 024.PLL unlock or WKR MODEM 030.PLL unlock alarm is occurring, that mark remains as shown below until the equipment is restored to normal conditions.

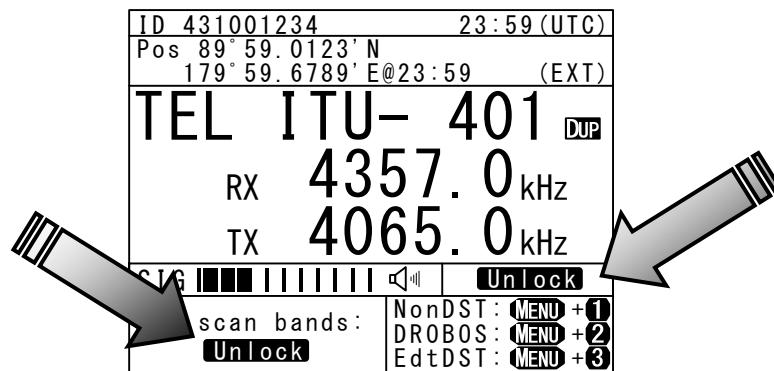

6.3.1 Alarm list

The following list shows the types of system alarms and contents when an alarm is detected on the equipment.

Alarm Number	Source Unit	Display	Contents	Troubleshooting Procedure
001	PA	Overcurrent	Detected an overcurrent (20 A or more) in the PA power supply.	Re-tune or operate on another frequency.
007	PA	SWR/Overload	Detected the condition SWR > 3.	Re-tune or operate on another frequency.
008	PA	High temperature	Detected an out-of-range temperature (110°C or more) at the radiator.	Stop transmission, or reduce output.
010	PA	RBK overcurrent	Detected RBK overcurrent.	<i>Please contact JRC or our agency.</i>
055	PA	24V low voltage	Detected a drop (12V or less) in the PA power supply voltage.	<i>Please contact JRC or our agency.</i>
091	PA	EEPROM	Detected a memory error.	<i>Please contact JRC or our agency.</i>
017	ATU	ATU lost	Detected a serial communication error with the tuner.	<i>Please contact JRC or our agency.</i>
018	ATU	High voltage	Detected a high voltage (3.5 kV or more) in antenna output.	Re-tune, or reduce output.
019	ATU	High temperature	Detected an out-of-range temperature (70°C or more) inside the enclosure.	Stop transmission, or reduce output.
020	TRX	DISP_KEY	Detected abnormal ON signal at the PTT or Ext key of the controller.	<i>Please contact JRC or our agency.</i>
021	TRX	EXT_KEY	Detected abnormal ON signal at the transceiver external key.	<i>Please contact JRC or our agency.</i>
022	TRX	SEL_BK	Detected abnormal ON signal at the Selcall key on the transceiver.	<i>Please contact JRC or our agency.</i>
023	TRX	-BK	Detected the -BK output error during transmission.	<i>Please contact JRC or our agency.</i>
024	TRX	PLL unlock	Detected PLL unlock for the DDS or DUC clock.	<i>Please contact JRC or our agency.</i>
030	WKR MODEM	PLL unlock	Detected PLL unlock for the DDS clock.	<i>Please contact JRC or our agency.</i>
031	WKR MODEM	MCDSP WDT	Detected MCDSP malfunction.	<i>Please contact JRC or our agency.</i>
032	WKR MODEM	VDSP WDT	Detected VDSP malfunction.	<i>Please contact JRC or our agency.</i>
033	WKR MODEM	MMSI lost	Detected non-registration or loss of the ship's MMSI.	<i>Please contact JRC or our agency.</i>
094	WKR MODEM	Memory	Detected a memory error.	<i>Please contact JRC or our agency.</i>
035	Controller	CTRL1 RBK OC	Detected an overcurrent on the RBK circuit of controller 1.	<i>Please contact JRC or our agency.</i>
036	Controller	CTRL1 PTT	Detected an error on the PTT control line of controller 1.	<i>Please contact JRC or our agency.</i>
037	Controller	CTRL1 CW KEY	Detected an error on the CW key control line of controller 1.	<i>Please contact JRC or our agency.</i>
038	Controller	CTRL1 EXT KEY	Detected an error on the external key control line of controller 1.	<i>Please contact JRC or our agency.</i>
039	Controller	CTRL2 RBK OC	Detected an overcurrent on the RBK circuit of controller 2.	<i>Please contact JRC or our agency.</i>
040	Controller	CTRL2 PTT	Detected an error on the PTT control line of controller 2.	<i>Please contact JRC or our agency.</i>
041	Controller	CTRL2 CW KEY	Detected an error on the CW key control line of controller 2.	<i>Please contact JRC or our agency.</i>
042	Controller	CTRL2 EXT KEY	Detected an error on the external key control line of controller 2.	<i>Please contact JRC or our agency.</i>
047	Controller	PA lost	Detected a serial communication error with the PA.	<i>Please contact JRC or our agency.</i>
048	Controller	TRX lost	Detected a serial communication error with the TRX.	<i>Please contact JRC or our agency.</i>

050	Controller	MODEM lost	Detected a serial communication error with the WKR MODEM.	<i>Please contact JRC or our agency.</i>
051	Controller	CTRL1 lost	Detected a serial communication error with the No.1 controller.	<i>Please contact JRC or our agency.</i>
052	Controller	CTRL2 lost	Detected a serial communication error with the No.2 controller.	<i>Please contact JRC or our agency.</i>
095	Controller	CTRL1 memory	Detected a memory error on the No.1 controller.	<i>Please contact JRC or our agency.</i>
096	Controller	CTRL2 memory	Detected a memory error on the No.2 controller.	<i>Please contact JRC or our agency.</i>
059	Data terminal	My/OTH DTE lost	Detected a serial communication error between controller (ID:1) and DTE. Note) My or OTH indicates the relationship between that data terminal and the controller displaying this alarm.	Check the data terminal cable connection, or the condition of the data terminal.
060	Data terminal	My/OTH DTE lost	Detected a serial communication error between controller (ID:2) and DTE. Note) My or OTH indicates the relationship between that data terminal and the controller displaying this alarm.	Check the data terminal cable connection, or the condition of the data terminal.
062	Data terminal	My/OTH DTE USB-IC	Detected the SPI communication error at the USB circuit of the data terminal connected to the controller (ID:1). Note) My or OTH indicates the relationship between that data terminal and the controller displaying this alarm.	<i>Please contact JRC or our agency.</i>
063	Data terminal	My/OTH DTE USB-IC	Detected the SPI communication error at the USB circuit of the data terminal connected to the controller (ID:2). Note) My or OTH indicates the relationship between that data terminal and the controller displaying this alarm.	<i>Please contact JRC or our agency.</i>

Also, the following alarms are displayed when an error is detected just after turning on the equipment. Please notify JRC or our agency of the details of the alarm.

Display	Contents
Detected this controller's barcode number lost! So required to replace the CONTROL UNIT in it with the new one.	Detected an error in the barcode number on the controller.
Detected this controller's SIO error! So required initial set after restarting as the maintenance mode.	Detected a communication error between the controller and transceiver at startup.
Detected this controller's address setting error! So required initial set after restarting as the maintenance mode.	Detected this controller's address error when starting the controller.
Detected MMSI lost! So concerned DSC functions no longer available now.	Unregistered MMSI, or lost the MMSI.
Detected PA UNIT lost or this controller's SIO error! So required initial set after restarting as the maintenance mode.	Detected malfunction of the PA unit or communication error on the controller.
Detected TRX UNIT lost! So concerned all functions no longer available now.	Detected TRX unit malfunction.

6.3.2 Viewing the alarm history

The following describes how to view alarm information detected by the equipment or a history of past occurring alarms in the 6.2 Alarm information menu.

■ Procedure ■

1. Press the **MENU** key, and through hierarchical menus, select 6.2 Alarm information.

One of the screens shown at right is displayed indicating if an alarm is occurring.

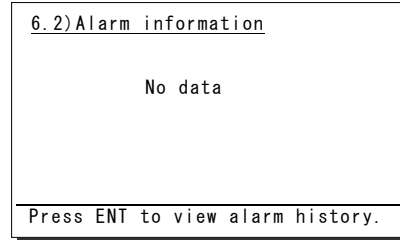

(If there is no alarm)

Note The displayed alarm information is formatted as follows.

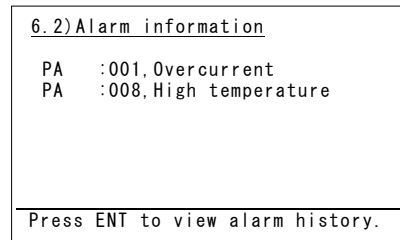
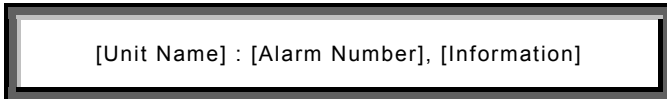

(If there is an alarm)

2. To check the alarm history, press ENT. The popup screen at right is displayed, select OK.

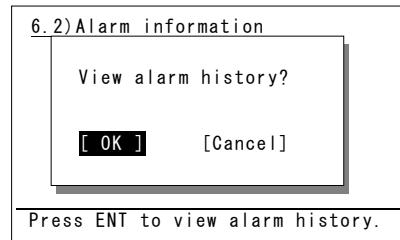

3. The alarm history is displayed. Up to 100 of the latest histories are stored. If necessary, scroll with the jog dial.

Note The displayed alarm history is formatted as follows.

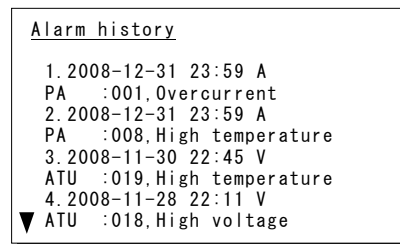
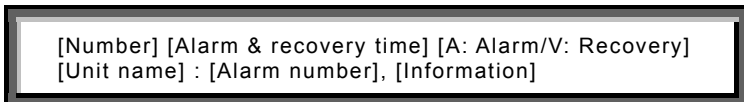

6.4 Software version

To view the version of the software currently running on the equipment, press the **MENU** key, and display 6.3 Software version in the menu list.

- Each software version of the transceiver, the controller and the data terminal is displayed as shown at right.
- Besides above, the software version of the data terminal is displayed through the Help menu.

```
6.3)Software version
- Controller :05.00
- WKR MODEM :03.00
- TRX       :01.00
- PA        :01.00
- ATU       :01.00
- DTE       :01.00
0. Back
```

6.5 Troubleshooting

WARNING



This equipment is used for both distress communication and routine communication. Contact JRC or our agent if any problem is observed in this unit during routine operation or inspection.



Do not open the equipment to inspect or repair internal circuits. Inspection or repairs by anyone other than a specialized technician may result in fire, electrical shock, or malfunction. If internal inspection or repair is necessary, contact our service center or agents.

6.5.1 Procedures for locating malfunctions

- 1) First, check the power supply voltage and connectors.
- 2) If there are no problems with the above, use a tester to check for errors.

The following table shows the instruments required for performing repairs and the severity of the malfunctions. If the user is to locate the malfunction himself, perform only No. 1 and No. 2.

No.	Type of Malfunction	Examples
1	Faults requiring no instrument to locate	<ul style="list-style-type: none"> • Faulty connector contacts • Broken antenna cables • Defective switches, controls, etc. • Other problems that can be visually detected
2	Malfunctions that can be discovered and repaired with a tester	<ul style="list-style-type: none"> • Confirmation of power supply voltage • Breaks in external wiring
3	Malfunctions requiring special instrument	<ul style="list-style-type: none"> • Fan malfunction in transceiver and ATU enclosure fan • Crystal oscillator frequency deviation • Decrease in transmitting power and reception sensitivity • Decrease in transmitter modulation level • Malfunction in semiconductors, ICs, and similar devices

6.5.2 Guide to locating faults

Use the following table as a guide to locating the causes of malfunctions in the equipment. Also, when contacting JRC or our agency, please notify us of the malfunction conditions.

No.	Symptom	Typical causes
1	Nothing is displayed on the controller or the data terminal screen.	<ul style="list-style-type: none"> • Malfunction in the controller or data terminal cable • Abnormal power supply voltage • Malfunction in the power switch, display circuit or control circuit
2	TX and ON is displayed but no voice is transmitted in the TEL mode.	<ul style="list-style-type: none"> • Malfunction in the handset • Malfunction in the controller cable • Malfunction in the AF signal transmission circuit
3	TX is displayed but ON is not, and transmission is not possible.	<ul style="list-style-type: none"> • Malfunction in the transmission circuit
4	TX and ON are displayed, and transmission is not possible.	<ul style="list-style-type: none"> • Malfunction in the handset PTT switch (TEL mode) • Malfunction in the electrical key connection (CW mode) • Malfunction in the transmission circuit
5	Reception sensitivity is poor.	<ul style="list-style-type: none"> • Antenna damage • Break or short circuit of antenna cable • Malfunction in the antenna connectors • Malfunction in the receiver circuit
6	Little or no sound from the speaker, both static and voices.	<ul style="list-style-type: none"> • Malfunction in the speaker • Malfunction in the receiver circuit
7	Radio static (noise) is output from the speaker, but cannot receive transmissions from other stations.	<ul style="list-style-type: none"> • Antenna damage • Break or short circuit of antenna cable • Malfunction in the antenna connectors • Malfunction in the receiver

Note The following are not faults.

Symptom	Possible Causes	Handling
Both Tx & Rx functions are invalid, and the SIG meter indicates off-the-scale.	The external BK line is ON.	Stop operating the external equipment.
The VOL control, the dimmer, and PWR key on the controller are valid but functions such as the RF GAIN control are invalid.	Multiple controllers are connected, and another controller has access rights.	Press ENT to obtain access rights, and after that, retry the operation.
No response from other station via radiotelephone or DSC call.	No operator in that station, or unavailable to respond due to other duties.	Wait and retry later.
When multiple controllers are connected, access rights cannot be obtained by pressing ENT on a monitor controller.	Another controller with higher priority is in use for communicating or is performing menu operations.	After operations on the other controller are finished, obtain access rights.
If the system is left on a screen other than the status display for a while, the screen returns to the status display.	The inactivity timer is activated and the menu is closed.	Set the timer with the 7.3.6 Menu shutdown.
The received distress call log has been erased without operation.	Automatically deleted the received distress calls of 48 hours old after that reception. (IMO A.806(19)) Or the equipment had been turned off by such as the breaker on the power supply.	Print and save received messages if necessary.
When turning on the data terminal, the start screen is displayed. But after that, nothing is displayed.	The dimmer level is adjusted to 0 with such as Ctrl+↓ operation.	Adjust the dimmer level with the DIM key on the panel of the data terminal or Ctrl+↑ operation.

6.5.3 Consumables

The following shows consumables. Please contact JRC or our agency to order parts.

Location	Description	Model (Part number)	Replacement Guide
NKG-91 PRINTER	Printer paper	7ZPJD0384	Indicating red mark on the paper edge
DPU-414 PRINTER	Printer paper	6ZCAF00252A	
NKG-800 PRINTER	Printer paper	5ZPCM00020 (L=100m)	Indicating red mark on the paper edge
		5ZPAL00002 (L=105m)	
	Ink ribbon (SP-16051)	5ZZCM00003	When print becomes light
NKG-900 PRINTER	Printer paper	5ZPCM00020 (L=100m)	Indicating red mark on the paper edge
		5ZPAL00002 (L=105m)	
	Ink ribbon (7Q1VP80S)	7ZZJD0105	When print becomes light

6.5.4 Repair units/parts

The repair units and replacement part units are as follows.

● NTD-2150 MF/HF TRANSCEIVER

Description	Model (Part number)	Notes
PA UNIT	CAH-2415	
TRX UNIT	CMN-2250	
WKR MODEM UNIT	CMJ-2250	
POWER SUPPLY	CBD-2415	
TERMINAL UNIT	CQD-2415	
EXTENSION BOARD	CQD-2416	

● NCM-2150 MF/HF CONTROLLER

Description	Model (Part number)	Notes
CONTROL UNIT	CDJ-3775	
AF CONT UNIT	CMV-3775	
LCD UNIT	CDE-3770	
MAIN PANEL UNIT	CCK-3775	
SUB PANEL UNIT	CCK-3776	
SPEAKER	7USJD0007	
CONTROLLER CABLE	7ZCJD0343	Control cable (5 m)

● NFC-2150 ANTENNA TUNER

Description	Model (Part number)	Notes
MATCHING UNIT	CFG-2150	

● NDZ-227 DATA TERMINAL

Description	Model (Part number)	Notes
PROCESS CIRCUIT	CDC-1346B	
INTERFACE UNIT	CMH-3227	
COLOR LCD UNIT	CCN-3227	10.4 inch
LCD I/F UNIT	CQC-1262	
USB I/F UNIT	CQD-3227	

● NBB-714 BATTERY CHARGER

Description	Model (Part number)	Notes
AC fuse	7ZFJD0002	10A
NBB714_Dustfilter	NBB714-FIL	
NBB714_Fan	NBB714-FAN	

● NBB-724 BATTERY CHARGER

Description	Model (Part number)	Notes
NBB724_Dustfilter	NBB724-FIL	
NBB724_Fan	NBB724-FAN	

6.5.5 Regular replacement parts

The following shows parts that need to be replaced regularly. Please contact JRC or our agency to order parts.

Description	Model (Part number)	Replacement Period
Cooling fan	3108NL-05W-B50-L09	Approx. 50,000 hours of use at room temperature
LCD unit for controller	CDE-3770	Approx. 20,000 hours of continued use at maximum brightness
LCD unit for data terminal	CCN-3227	Approx. 50,000 hours of continued use at maximum brightness

7. AFTER-SALES SERVICE

★ Warranty

The **warranty period** is determined by JRC's warranty regulations, but is normally 1 year from the date of purchase. Additionally, the warranty except for the body text is submitted to contractual agreements.

★ Repair Part Inventory Period

Parts necessary for proper functioning of this equipment will be kept available for 10 years after product discontinuation.

★ When Requesting Repairs

If what appears to be a defect is detected, refer to "6.5 Troubleshooting" to check if the equipment is actually defective.

If the problem is due to a defect, immediately stop use of the system and contact the store where you purchased the system, or one of our branches.

- **During the warranty period**, if a malfunction occurs with the equipment while in standard usage in accordance with this instruction manual, we or our agencies will repair the malfunction at no charge at the store where the equipment was purchased or another location specified by JRC. If the malfunction occurs due to improper usage, fault (including the use of the virus-infected USB flash memory), or any external abnormal condition such as fire, pollution, abnormal voltage, natural disaster (ex. thunder storms, earthquake) etc., JRC will repair the equipment for a fee. Furthermore, regardless of the warranty period, orders of consumables will be charged.

- **After the warranty expires**, we will repair the malfunction for a fee, if repair is possible.

- **Please inform us of the following**:

- ☆ Product name, model name, manufactured date, serial number
- ☆ As much information as you can provide about the malfunction (alarm number, whether transmission is possible or not, etc.)
- ☆ Your company or organization name, address, and phone number

★ Periodical Maintenance Recommendation

Depending on the usage conditions, with extended use, the performance of this equipment may degrade over time, and externally installed parts such as the antenna may degrade due to vibration, so we recommend periodical maintenance in addition to the standard maintenance.

Please contact the store where you purchased the equipment, or one of our branches, to request periodical maintenance.

Periodical maintenance requires a service charge.

If you have any questions regarding after-sales service, please contact the store where you purchased the equipment, or one of our branches.

Refer to the inside of the back cover for contact numbers and locations.

8. DISPOSAL

Observe all rules and regulations of the local authorities when disposing of this equipment.

9. SPECIFICATIONS

9.1 JSS-2150 150W MF/HF Radio Equipment

● General Specifications

Transmission frequency	1605.0 - 27500.0 kHz (100 Hz steps)
Reception frequency	90.0 - 29999.9 kHz (100 Hz steps)
Frequency stability	Within ± 10 Hz
Type of emission	TEL mode : J3E DSC/TLX mode : F1B CW mode : A1A AM mode : H3E H2B mode : H2B DATA mode : J2D
Channels	User channels (TEL/DSC/CW) : Max. 400 ch (20 ch x 20 grp) User channels (TLX) : Max. 400 ch (20 ch x 20 sta) ITU preset channels : 1722 ch
Scan channels	Max. 20 channels (group specification method)
Nominal frequency	J3E/ A1A/ H3E/ H2B/ J2D : Carrier frequencies F1B : Assigned frequency
Communication method in TEL	Push-to-talk (simplex, semi-duplex)
Antenna impedance	50 Ω unbalanced
Channel switching duration	15 sec or less
Interface	IEC61162-1 (GPS/AME/RMS)
Compass safety distance	2.0 m
Main controls	DSC call (sending and receiving), communication freq/ channel settings, Tx power settings, RF gain adjustment, volume adjustment, LCD adjustment
Performance criteria	IMO A.806(19), A.694(17), MSC68(68), MSC/Circ.862 IEC 60945 Ed.4 2002-08
Power supply voltage	24 VDC (21.6 VDC to 31.2 VDC)
Current consumption	150W transmission : Maximum 30 A Reception: : Maximum 5 A
Operating temperature range	-15°C - +55°C(parts exposed to condensation -25°C - +55°C)
Storage temperature range	-15°C - +55°C(parts exposed to condensation -25°C - +70°C)
Humidity resistance	No abnormality after standing 10 hours in +40°C, 93%RH
Vibration resistance (3 axes)	2 Hz - 5 Hz to 13.2 Hz : Full amplitude ± 1 mm $\pm 10\%$ 13.2 Hz to 100 Hz : Maximum acceleration 7m/s ² fixed No abnormality after testing resonance points or at 30 Hz for 2 hours
Continuous operation (TEL)	No abnormality after operating continuously for 8 hours
Continuous operation (DSC,WKR)	No abnormality after operating continuously for 24 hours
Category type of the weather resistance	Antenna tuner and the junction box : Exposed Other units : Protected
Protection rating	IP22 equivalent (controller panel)
Dimensions and mass	Transceiver 349mm(W) x 391mm(H) x 143mm(D) [excluding projections], approximately 12.3kg Antenna tuner 256mm(W) x 430mm(H) x 100mm(D) [excluding projections], approximately 3.3kg Controller 230mm(W) x 142mm(H) x 89mm(D) [excluding projections], approximately 1.4kg Data terminal 336mm(W) x 244mm(H) x 88mm(D) [excluding projections], approximately 4.6kg

Specifications

● Transmitter

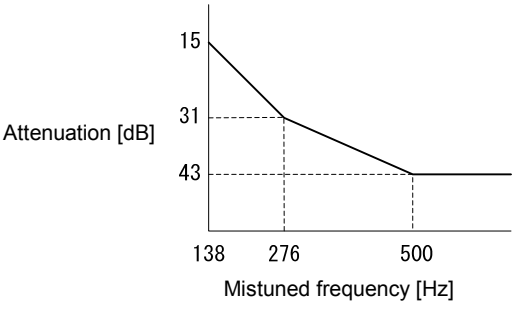
Antenna output power	1605.0 - 3999.9 kHz : 75 ~ 100W _{pep} 4000.0 - 27500.0 kHz : 75 ~ 150W _{pep}
Modulation method	Low-power stage balanced modulation
Occupied bandwidth	J3E/ J2D/ H2B : Within 3 kHz F1B/ A1A : Within 0.5 kHz
Carrier suppression (J3E)	40 dB or more
Unwanted emissions in the out-of-band domain	Mean power of 50 mW or lower, or 43 dB or more lower than the mean power of the basic frequency
Unwanted emissions in the spurious domain	At J3E: 1.5 to 4.5 kHz : 31 dB or more 4.5 to 7.5 kHz : 38 dB or more 7.5 kHz and upwards : 43 dB or more (Peak power of unwanted emissions is 50 mW or less.) At F1B: 
Overall distortion and noise	-20 dB or less
AF frequency response	Deviation is within 6 dB in 350 Hz to 2700 Hz range.
Tone frequency	1500 Hz or 1400 Hz

● Receiver

Receiving system	Double superheterodyne
1st IF	70.036 MHz
2nd IF	36 kHz
Reception frequency stability	Within ± 10 Hz
Sensitivity (SINAD 20dB)	J3E : 2.5 μ V or less (1605.0 to 27500.0 kHz) F1B : 0.7 μ V or less (1605.0 to 27500.0 kHz) A1A : 1.4 μ V or less (1605.0 to 27500.0 kHz)
Pass band/Adjacent signal selectivity	J3E : 2.4 - 3.0 kHz (6 dB bandwidth) within ± 2.1 kHz (66 dB bandwidth) F1B : 270 - 300Hz (6 dB bandwidth) within ± 550 Hz (60 dB bandwidth)
Spurious response	J3E : 60 dB or more F1B : Symbol error rate of 1% or better at a wanted signal level of 10 μ V and an unwanted signal level of 31.6 mV separated by 750 Hz
Blocking/Desensitization	J3E : When an unwanted signal level separated by 3 kHz is added to the wanted signal level of 10 μ V, the unwanted signal input voltage suppressing output of the wanted signal by 3 dB is 10 mV or more. F1B : Symbol error rate of 1% or better at a wanted signal level of 10 μ V and an unwanted signal level of 1 mV separated by 500 Hz
Overall distortion and noise	When an input signal level of 30 μ V is applied, the ratio between low-frequency output 1000 Hz and unwanted components contained in that output is 30 dB or more.
Conducted spurious emission	Power emitted from antenna terminal is 2 nW or less (9kHz - 2GHz) and 20 nW or less (2GHz - 4GHz).
Clarifier variable range	± 200 Hz (1 Hz steps)
Antenna impedance	50 Ω unbalanced
Line output	0 dBm 600 Ω (balanced)

● DSC Watch Keeping Receiver

Reception frequency	Distress and safety frequencies of 2187.5 kHz and 8414.5 kHz, and additionally on one or more of the 4207.5 kHz/ 6312.0 kHz/ 12577.0 kHz/ 16804.5 kHz
Receiving system	Double superheterodyne
1st IF	40.04025 MHz
2nd IF	40.25 kHz
Frequency stability	Within ± 10 Hz
Sensitivity	1% or lower symbol error rate at reception input voltage of $1\mu\text{V}$
Passband	6 dB bandwidth : 270 - 300 Hz 30 dB bandwidth : Within ± 380 Hz 60 dB bandwidth : Within ± 550 Hz
Spurious response	Symbol error rate of 1% or better when an unwanted signal level of 31.6 mV is applied to a wanted signal level of 10 μV from an intermediate frequency separated by 750 Hz or more through to a frequency 3x the test frequency
Blocking/Desensitization	Symbol error rate of 1% or better at a wanted signal level of 10 μV and an unwanted signal level of 1 mV separated by 500 Hz
Conducted spurious emission	Power emitted from antenna terminal is 2 nW or less.
Antenna impedance	50 Ω unbalanced

● DSC Modem

Modulation rate	Within 100 baud $\pm 30 \times 10^{-6}$
Modulation method	FSK (sub-carrier: 1700 Hz)
Mark frequency (Y)	Transmission : Within 1615 Hz ± 0.5 Hz Reception (permissible value) : Within 1615 Hz ± 20 Hz
Space frequency (B)	Transmission : Within 1785 Hz ± 0.5 Hz Reception (permissible value) : Within 1785 Hz ± 20 Hz
DSC Protocol	ITU-R recommendation M.493-13 (Class A and B)
DSC operation standards	ITU-R recommendation M.541-9, M.821-1
DSC code	10-bit error detecting code
Message storage	20 Rx distress, 20 Rx others, 20 Tx messages

● NBDP Modem

Modulation rate	Within 100baud $\pm 30 \times 10^{-6}$ 以内
Modulation method	FSK (sub-carrier : 1700Hz)
Mark frequency (Y)	Transmission : Within 1615 Hz ± 0.5 Hz Reception (permissible value) : Within 1615 Hz ± 20 Hz
Space frequency (B)	Transmission : Within 1785 Hz ± 0.5 Hz Reception (permissible value) : Within 1785 Hz ± 20 Hz
NBDP Protocol	ITU-R recommendation M.476-5, M.491-1, M.492-6, M.625-4 ITU-T recommendation F.1、F.130、S.6
NBDP code	7-bit error detecting code

● Antenna tuner

Frequency range	1605.0 - 27500.0 kHz
Max. input power	1605.0 - 3999.9 kHz : 150Wpep 4000.0 - 27500.0 kHz : 200Wpep
SWR after tuning	2:1 or less
Tuning method	Preset or auto-tuning
Tuning time	Preset tuning: 0.5 seconds, auto-tuning: max. 45 seconds
Power supply	24 VDC (21.6 VDC to 24.7 VDC)

Specifications

● MF/HF controller

Communication speed	57.6 kbps
Communication interface	RS-485 and RS-232C, and Centronics compliant
Microphone input impedance	150Ω balanced
Standard modulation input	-54 dBm
Audio output	Internal loud speaker (8Ω) : 5W max External speaker impedance : 8Ω or more Handset phone (150Ω) : Rated 1mW or more
LCD display	3.8 inch FSTN monochrome, 320 x 240 dot, LED backlight

● Data terminal

Communication speed	4.8kbps
Communication interface	RS-232C
USB interface	USB 2.0, FAT16/32 file format
Keyboard interface	PS/2
Printer interface	Centronics compliant
LCD display	10.4 inch TFT color, 640x480 dots, CCFL backlight Standard brightness 450cd/m ² , Viewing angle 160° /140° Contrast 600 : 1

● Keyboard

Communication interface	Serial two wire interactive transmission
Connector	Mini DIN 5Pin
Durability	20,000,000 times

● Printer (NKG-800/900)

Printing system	Serial impact dot matrix
Communication interface	Centronics compliant
Paper feed system	Roll paper holder
Paper type	209 - 216 mm (8.23 - 8.50") roll paper
Buffer size	21 kbytes (NKG-800) 64 kbytes (NKG-900)
Power supply voltage	10.2 VDC - 31.2 VDC
Power consumption	Maximum 35 W

9.2 Options

(1) AC/DC Power supply (NBD-2150)

Source voltage	90 VAC to 264 VAC (50/60 Hz) and 24 VDC (21.6 VDC to 31.2 VDC)
Output voltage	AC operation : 24 VDC DC operation : Outputs the DC-IN directly
Maximum output current	30 A
Source switching function	Automatic switching to DC power when AC power is cut off. (uninterrupted output) Automatic switching from DC to AC when AC power is restored.
Alarm notification functions	AC power OFF
Temperature range for full performance	-15°C - +55°C
Operating temperature range	-15°C - +55°C
Storage temperature range	-25°C - +65°C
Humidity resistance	No abnormality after standing 10 hours in +40°C, 93% RH
Vibration resistance (3 axes)	2 Hz - 5 Hz to 13.2 Hz: : Full amplitude $\pm 1 \text{ mm} \pm 10\%$ 13.2 Hz to 100 Hz: : Maximum acceleration 7 m/s ² fixed No abnormality after testing resonance points or at 30 Hz for more than 2 hours
Continuous operation	No abnormality after operating continuously for 8 hours

(2) Battery charger (NBB-714)

Source voltage	90 VAC to 132 VAC or 180 VAC to 264 VAC (50/60 Hz)
Current consumption	Charging : 8 A or less (100 VAC input) 4 A or less (220 VAC input) Discharging : 0.3 A or less (at 24 VDC ope)
Charging current	Maximum 10 A
Charging circuit/ characteristic	Floating charge 16 VDC or more: Constant voltage or current characteristic Less than 16 VDC: Reduced current characteristic* (*) Foldback current limiting characteristic
Functions	Overvoltage input protection, Reverse polarity protection, Dimmer lamp, Alarm mute with remote control
Alarm type	Batt low/high voltage, Internal temperature, AC fail, Other abnormal charging
Temperature range for full performance	-15°C - +55°C
Operating temperature range	-15°C - +55°C
Storage temperature range	-25°C - +65°C
Humidity resistance	No abnormality after standing 10 hours in +40°C, 93% RH
Vibration resistance (3 axes)	2 Hz - 5 Hz to 13.2 Hz: : Full amplitude $\pm 1 \text{ mm} \pm 10\%$ 13.2 Hz to 100 Hz: : Maximum acceleration 7 m/s ² fixed No abnormality after testing resonance points or at 30 Hz for more than 2 hours

Specifications

(3) Battery charger (NBB-724)

Source voltage	90 VAC to 132 VAC or 180 VAC to 264 VAC (50/60 Hz)
Current consumption	Charging : 15 A or less (100 VAC input) 8 A or less (220 VAC input) Discharging : 0.5 A or less (at 24 VDC ope)
Charging current	Maximum 22 A (Common to Floating & Equalizing charge)
Charging circuit/ characteristic	Floating charge and equalizing charge 18 VDC or more: Constant voltage or current characteristic Less than 18 VDC: Reduced current characteristic* (*) Foldback current limiting characteristic
Functions	Overvoltage input protection, Reverse polarity protection, Dimmer lamp, Float/Equal changing, DC ope, Batt temp
Alarm type	Batt low/high voltage, Internal temperature, Other abnormal charging
Temperature range for full performance	-15°C - +55°C
Operating temperature range	-15°C - +55°C
Storage temperature range	-25°C - +65°C
Humidity resistance	No abnormality after standing 10 hours in +40°C, 93% RH
Vibration resistance (3 axes)	2 Hz - 5 Hz to 13.2 Hz: : Full amplitude $\pm 1 \text{ mm} \pm 10\%$ 13.2 Hz to 100 Hz: : Maximum acceleration 7 m/s ² fixed No abnormality after testing resonance points or at 30 Hz for more than 2 hours

(4) Printer (NKG-91)

Printing system	Thermal line dot
Communication interface	RS-232C, 4.8/9.6/38.4 kbps
Data control	RTS/CTS
Data buffer	4096 byte
Maximum print speed	20 mm/sec or more
Roll paper width	58 mm
Power supply voltage	6.5 VDC (5 VDC to 8.7 VDC)
Current consumption	Maximum 2 A

(5) Printer (DPU-414)

Printing system	Thermal serial dot
Communication interface	RS-232C, 4.8k/9.6k/38.4 kbps
Data control	HW busy
Data buffer	About 28 Kbyte
Maximum print speed	52.5 cps
Roll paper width	112 mm
Power voltage	6.5 VDC
Current consumption	Maximum 2 A

9.3 Peripheral interfaces

(1) GPS or other navigation aid interface

Interface standard	NMEA0183/ IEC61162-1 Ed.4 (2010-11) compliant
Protocol	4800 bps, start 1 bit, data 8 bit, stop 1 bit Non parity
Input sentence	NMEA0183 V1.5: GGA/ GLL/ RMC V2.0: GGA/ GLL/ RMC/ ZDA V2.3: GGA/ GLL/ RMC/ GNS/ ZDA (Talker = "GP" or other)
Data type	Ship position & time information: GGA/ GNS/ GLL/ RMC Date information: ZDA/ RMC Equipment time information: ZDA/ GGA/ GNS/ GLL/ RMC

(1.1) Electrical description

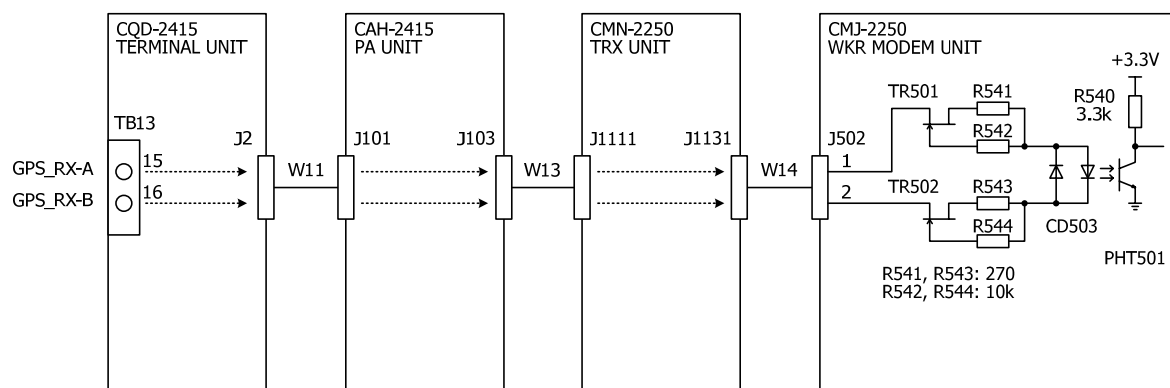

■ Load requirements

Current consumption	: 2mA at 2V or less
Maximum input voltage	: $\pm 15V$ or more
Recommended operating current	: 2mA or more

Specifications

(1.2) List of sentences and associated data fields

(1.2.1) GGA – Global positioning system (GPS) fix data

\$-GGA, hhhmss, llll.ll, a, yyyy.yy, a, x, xx, x.x, x.x, M, x.x, M, x.x, xxxx *hh<CR><LF>

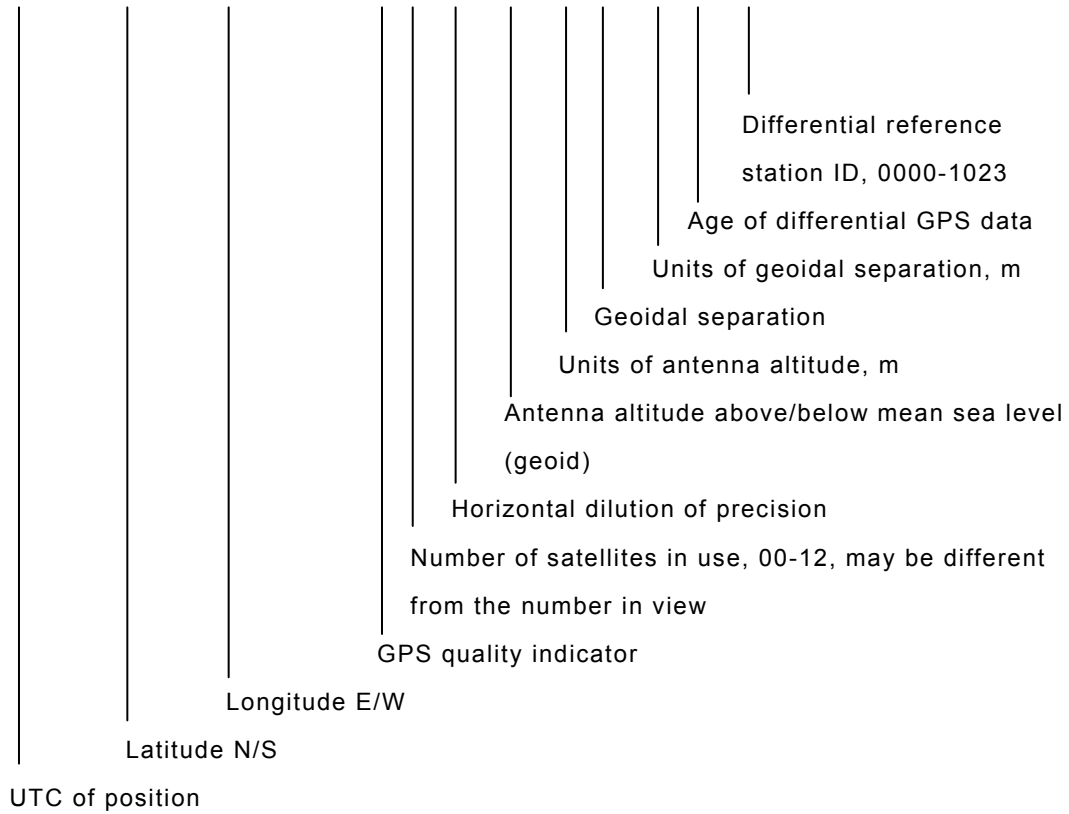

(1.2.2) GLL – Geographic position – Latitude/longitude

\$-GLL, llll.ll, a, yyyy.yy, a, hhhmss.ss, A, a *hh<CR><LF>

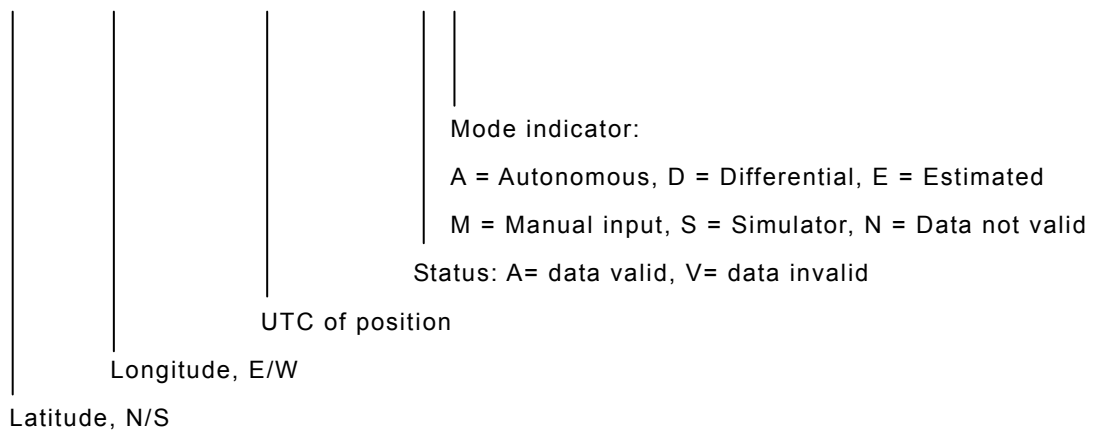

(1.2.3) RMC – Recommended minimum specific GNSS data

\$--RMC, hhhmss.ss, A, llll.ll, a, yyyy.yy, a, x.x, x.x, xxxxxx, x.x, a, a, a *hh<CR><LF>

hh	mm	ss.ss	A	llll.ll	a	yyyy.yy	a	x.x	x.x	xxxxxx	x.x	a	a	a	*hh

Navigational status
 Mode indicator:
 A = Autonomous, D = Differential,
 E = Estimated, F = Float RTK,
 M = Manual input, N = Data not valid
 P = Precise, R = Real Time Kinematic
 S = Simulator,
 Magnetic variation, degrees, E/W
 Date: dd/mm/yy
 Course over ground, degrees true
 Speed over ground, knots
 Longitude, E/W
 Latitude, N/S
 Status: A = data valid, V = navigation receiver warning

UTC of position fix

(1.2.4) GNS – GNSS fix data

\$--GNS, hhhmss.ss, llll.ll, a, yyyy.yy, a, c---c, xx, x.x, x.x, x.x, x.x, x.x, a *hh<CR><LF>

hh	mm	ss.ss	llll.ll	a	yyyy.yy	a	c---c	xx	x.x	x.x	x.x	x.x	x.x	a	*hh

Navigational status
 Differential reference station ID
 Age of differential data
 Geoidal separation, m
 Antenna altitude, m, re:mean-sea-level (geoid)
 HDOP
 Total number of satellites in use, 00-99
 Mode indicator:
 N = No fix, A = Autonomous, D = Differential,
 P = Precise, R = Real Time Kinematic, F = Float RTK,
 E = Estimated, M = Manual input, S = Simulator
 Longitude, E/W
 Latitude, N/S

UTC of position

Specifications

(1.2.5) ZDA – Time and date

\$--ZDA, hhmmss.ss, xx, xx, xxxx, xx, xx *hh<CR><LF>

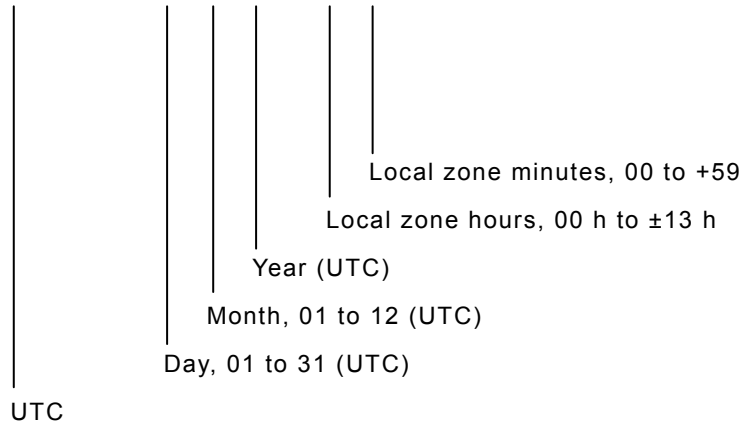

(2) RMS interface

Interface standard	IEC61162-1 compliant
Protocol	4800 bps, start 1 bit, data 8 bit, stop 1 bit Non parity
Output message	IEC61162-1 compliant proprietary sentence \$PJRCL sentence (for RMS log saving) \$PJRCM sentence (Device ID = "CT")
Data type	Model number, serial number, self-diagnosis information, etc.

10. OPTIONS OPERATION

10.1 AC/DC Power supply (NBD-2150)

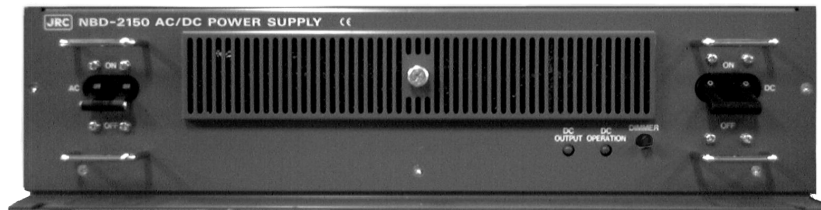

1. AC breaker
2. DC OUTPUT lamp
3. DC OPERATION lamp
4. Dimmer control
5. DC breaker



■ Procedure ■

1. Turn on the AC and DC breakers.

Turn on only the DC breaker when the AC input is not connected to the equipment.

2. Make sure that the DC OUTPUT lamp lights in green.

If this lamp is lit in green, this indicates that 24 V DC power is being output normally.

Note

- If only DC power is used, the DC OPERATION lamp lights. Be careful not to discharge the battery too much.
- If the DC OUTPUT lamp lights in red when the AC breaker is turned on, there may be abnormal condition or a malfunction with the AC power circuit as follows.
 - Input/Output overvoltage
 - Input/Output low voltage
 - Overcurrent
 - Failure of this unit

Additionally note that the DC power is output when the DC OPERATION lamp lights as mentioned above.

10.2 Battery charger (NBB-714)

⚠ CAUTION



When replacing fuses, always use fuses of the same type.

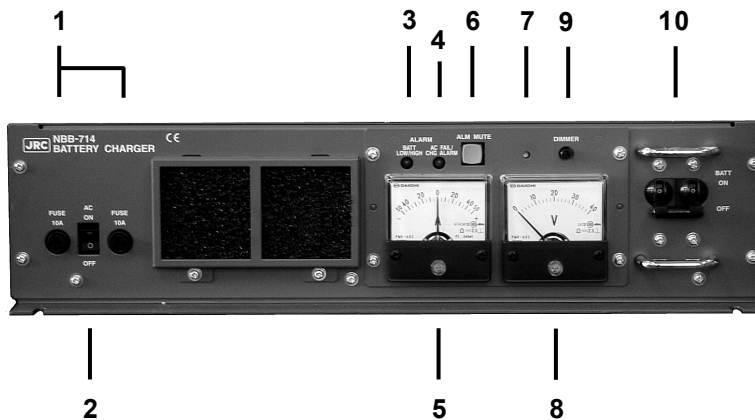

1. 10A fuse AC mains fuses (2pcs)
2. AC switch Turns on the AC mains power supply.
3. BATT LOW/HIGH lamp This lamp turns on and the buzzer sounds to indicate low voltage of the battery (approx. 21.5V). And also turns on and the buzzer sounds to indicate overvoltage of the battery (approx. 32.2 ~ 37.0V) and then, turns off the BATT breaker.
4. AC FAIL/ CHG ALARM This lamp turns on and the buzzer sounds to indicate any one of the following alarms.
 - While the BATT breaker is ON, the AC switch is OFF or any AC fails such as the power failure or the blowout of fuses.
 - While the AC switch is ON, the BATT breaker is OFF.
 - Over discharge detection (16V or less)
Note) If AC input is ON, charging is available without tripping the breaker.
 - Overheat detection (+80C)
5. Current meter Indicates the charge current (+) or discharge current (-).
6. ALM MUTE switch Silences the active alarm buzzer sound.
7. Alarm buzzer
8. Voltage meter Indicates the output voltage of the battery.
9. Dimmer control Adjusts the dimmer level of alarm lamps.
Note) Unable to turn off completely.
10. BATT breaker When turned on, connects the internal circuit to the battery, and after that turning on the AC breaker enables charging of the battery. Note that if detected over discharge of the battery (approx. 19.5V), this breaker trips automatically.

■ Procedure ■

Turn on the AC switch and the BATT breaker to start charging the battery.

- The AC FAIL/CHG ALARM is activated if the AC switch and BATT breaker are turned ON at different timing. However it is due to the notification function of the switch/breaker ON/OFF state and is NOT the alarm for any malfunction.
- The NBB-714 is a battery charger for the maintenance free battery only, i.e. the charging type is floating only and not providing the equalizing charge.

■ Replacing fuses ■

To replace fuses, turn off the AC switch and the BATT breaker first, and then unscrew the both two fuse cases as shown below to replace them.

Note) The appearance of the blowout fuses look like normal. So when checking if the fuses are blown or not, always use the tester.



Note

- The battery can be used as a secondary power source when the BATT breaker is ON while the AC breaker is OFF. However in this case, be sure not to cause over discharge condition.
- When any alarm is occurred, treat it as follows.
 - BATT HIGH When the battery overvoltage (32.2~37.0V) is detected, trips the BATT breaker. In this case, turn off the AC switch. And then, after the voltage is recovered to normal, turn on the AC switch and the BATT breaker.
Note) In this case, the charge alarm is also detected due to the BATT breaker trip and the CHG ALARM is activated.
 - BATT LOW Carry on charging. This alarm is cleared automatically after the battery voltage increases to approx. 23.5V.
 - AC FAIL/CHG ALARM
 - Turn on the AC input/switch.
 - After checking that the battery voltage is not overvoltage, turn on the BATT breaker.
 - If the battery is over discharge condition (16V), turn on both the AC switch and the BATT breaker to charge the battery.
 - High temperature The built-in charging circuit is disconnected until the temperature returns to the normal condition (60°C or lower) automatically

10.3 Battery charger (NBB-724)

⚠ CAUTION



The batteries, except for sealed lead-acid batteries that require no equalization, should be carried out the equalizing charge at least every six months

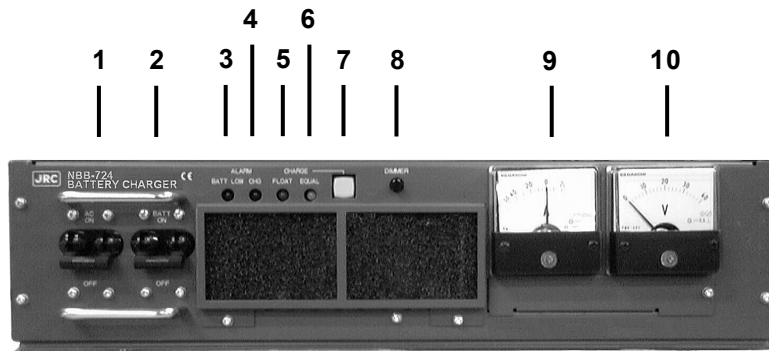

1. AC breaker When turned on, enables to use the AC mains input.
2. BATT breaker When turned on, connects the internal circuit to the battery, and after that turning on the AC breaker enables charging of the battery. Note that if detected over discharge of the battery (approx. 19.5V), this breaker trips automatically.
3. BATT LOW alarm lamp ... This lamp turns on and the buzzer sounds to indicate low voltage of the battery (approx. 21.5V).
4. CHG alarm lamp This lamp turns on (or blinks*) and the buzzer sounds to indicate any one of the following alarms.
 - The BATT breaker is OFF while the AC breaker is ON.
 - Over voltage (equalizing charge voltage + 1.0V)
 - High temperature of the charging circuit (+75°C) *
5. FLOAT charge lamp This lamp turns on during the floating charge operation.
6. EQUAL charge lamp This lamp turns on during the equalizing charge operation.
7. CHARGE mode switch ... Changes the charge mode between floating and equalizing charge.
8. Dimmer control Adjust the dimmer level.
9. Current meter Indicates the charge current (+) or discharge current (-).
10. Voltage meter Indicates the output voltage of the battery.

(1) Charging a battery in the floating mode

■ Procedure ■

Turn the AC and BATT breakers on.

- FLOAT lamp turns on during the floating charge operation.
- When turning on the AC breaker prior to BATT breaker, CHG alarm lamp turns on and the buzzer sounds. But this is not malfunction as mentioned above.

(2) Charging a battery in the equalizing mode

■ Procedure ■

1. Turn the AC and BATT breakers on.

Make sure FLOAT lamp is turned on and the battery charge is started in the floating mode.

2. Press the CHARGE mode switch.

- The lighting lamp is changed from FLOAT to EQUAL to indicate operating in the equalizing mode.
- The charging mode can be switched between FLOAT and EQUAL alternately.

3. When the equalizing charge is completed, returns to the floating mode automatically.

The equalizing charge is continued until the charge current goes down to approx. 3.0A or until 10 hours elapse.

Note

- The battery can be used as a secondary power source when the BATT breaker is ON while the AC breaker is OFF. However in this case, be sure not to cause over discharge condition.
- When any alarm is occurred, treat it as follows.
 - BATT LOW Carry on charging. This alarm is cleared automatically after the battery voltage increases to approx. 23.5V.
 - BATT breaker OFF Turn the BATT breaker on.
 - Over voltage Turn off the AC and BATT breakers until the battery voltage returns to the normal condition.
 - High temperature The built-in charging circuit is disconnected until the temperature returns to the normal condition (60°C or lower) automatically
 - Over discharge When the BATT breaker trips, turn on the breakers in the order of AC and BATT so that the charge operation is restarted.

10.4 Printer (NKG-91)

⚠ CAUTION



The thermal head of the NKG-91 printer may be very hot after printing. Do not touch the thermal head of the printer. Make sure that the thermal head is cool before replacing the paper or cleaning the thermal head.



The paper used in the NKG-91 printer is heat sensitive. Take the following precautions when using this paper.

- Store the paper away from heat, humidity, or heat sources.
- Do not rub the paper with any hard objects.
- Do not place the paper near organic solvents.
- Do not allow the paper to come in contact with polyvinyl chloride film, erasers, or adhesive tape for long periods of time.
- Keep the paper away from freshly copied diazo type or wet process copy paper.

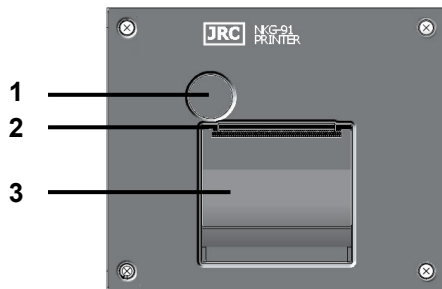

1. Paper cover open button
2. Paper cutter
3. Paper cover

■ Loading the printer paper ■

- 1.** Press the paper cover open button.

The paper cover will open.

- 2.** Insert the paper as shown in the diagram at right.

Position the paper such that the leading edge extends outside the printer, and press both sides of the paper cover to close it.

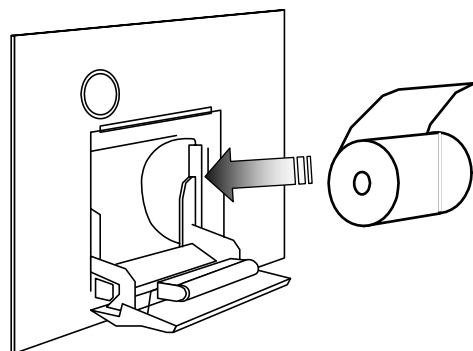

Note

The printer will be turned on and off simultaneously with the equipment.

10.5 Printer (NKG-800)

⚠ CAUTION



The print head of the NKG-800 printer may be very hot after printing. Do not touch the print head of the printer. Make sure that the print head is cool before replacing the paper or cleaning the print head.



Do not use the NKG-800 printer if there is no ink ribbon cartridge or paper. Do not twist the ink ribbon when installing the ink ribbon cartridge.



Before opening and closing the cover of the NKG-800 printer, turn off the printer. Wait more than 2 seconds after turning the printer off before turning it back on again so it can initialize correctly.

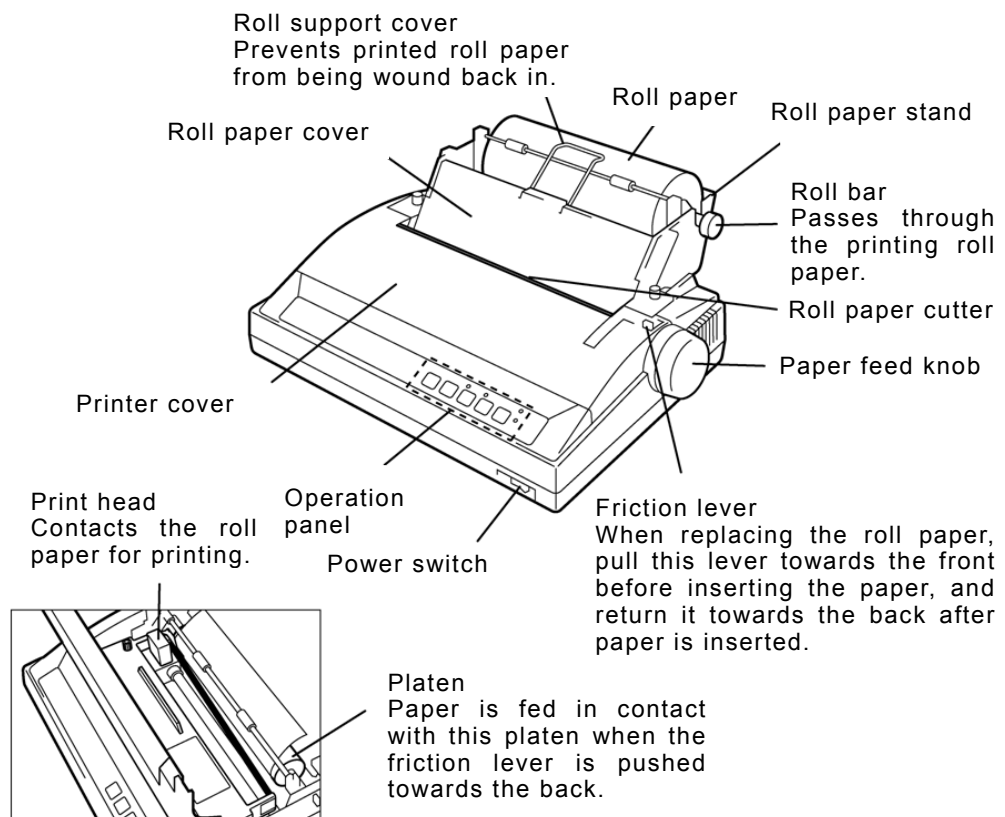

The following shows the functions of the operation panel.

P.PARK	FF	LF	NLQ	ONLINE
Paper Park Rewinds the roll paper.	Feed Form Feeds paper one page at a time.	Line Feed Feeds the paper one line at a time.	High-quality Printing Switches the printer to the high-quality printing mode.	Printer Ready Setting The printer is ready for printing when the lamp is lit.

Note 1: Before performing P.PARK/FF/LF/NLQ, press ONLINE to set the printer offline (lamp out).

Note 2: When the printer runs out of roll paper, the P.OUT lamp lights and the printer automatically goes offline.

■ Loading the printer paper ■

1. Turn the printer OFF, loosen the roll paper stand fixing screws, and slide the stand backwards to open the printer cover.

At this step, also remove the roll paper cover.

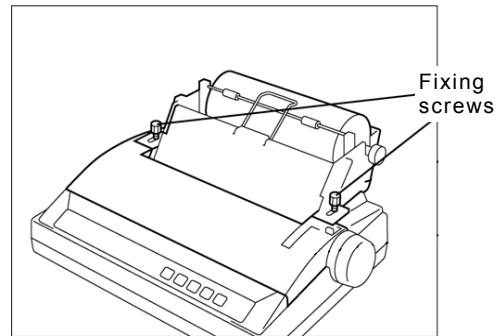

2. Pass the roll bar through the roll paper, and install the roll paper onto the roll paper stand paying attention to its orientation.

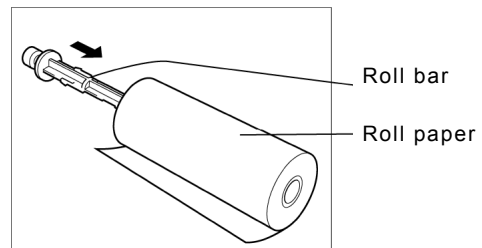

3. Pass the roll paper over the guide bar as shown in the figure at right.

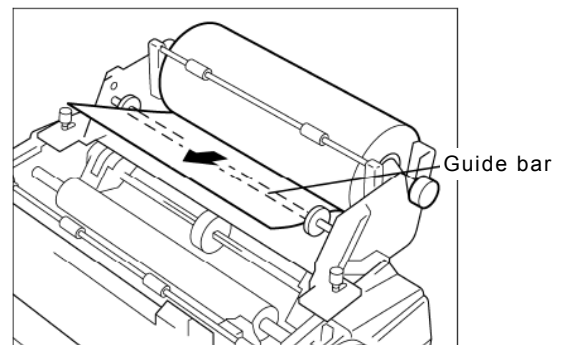

4. Pull the friction lever towards the front, and insert the leading edge of the paper into the rear of the platen. Then, return the friction lever to the back, and turn the paper feed knob to feed the paper out.

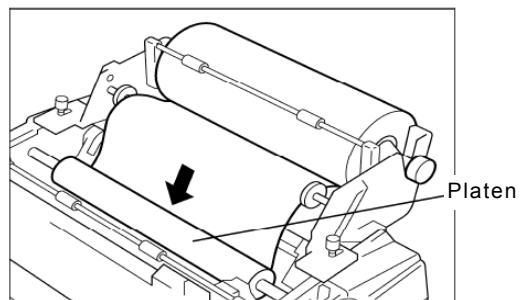

5. Lift the paper load lever up to hold down paper fed out of the platen.

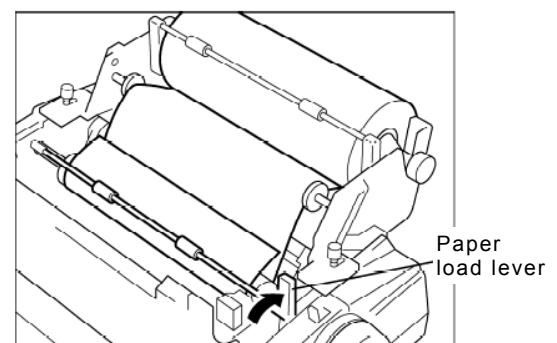

6. Return the roll paper cover to its original position, and place the roll support cover as shown in the figure at right.

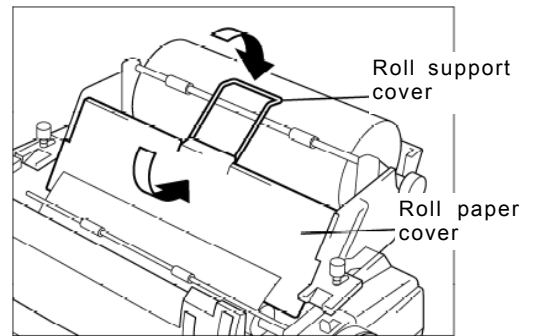

7. Close the printer cover, return the roll paper stand to its original position, and tighten the fixing screws.

Note

To perform a print test, turn the printer on with the LF key held down.
To end the print test, turn the printer off.

■ Replacing the ink ribbon ■

1. Turn the printer on, and following the same procedure as that in the previous section, open the printer cover, lift up the ink ribbon cartridge by holding the projection on the cartridge, and lift the cartridge up to remove it.

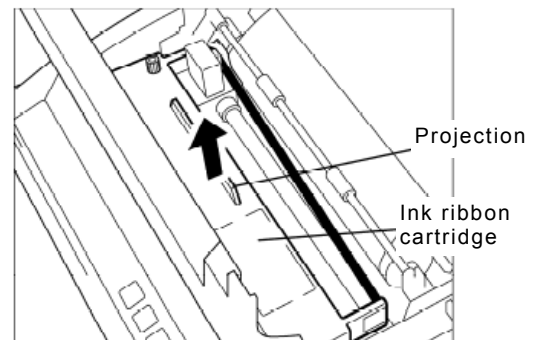

2. Using the knob on the new cartridge to make the ribbon taut, manually move the print head to the left edge, and attach the ribbon so that it is between the ribbon mask and print head.

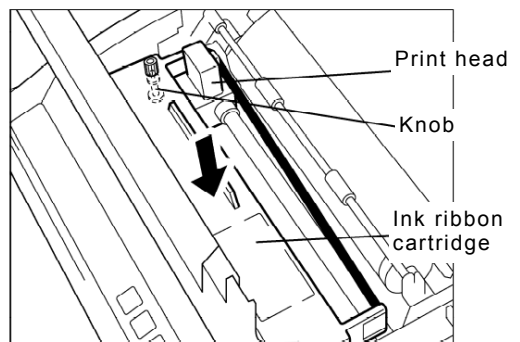

3. Close the printer cover, return the roll paper stand to its original position, and tighten the fixing screws.

Note

For other details, check the NKG-800 Installation Guide. The printer's operation mode can be set by the DIP switches. However, leave the DIP switch settings at their factory defaults (all off) when using the printer connected to the equipment.

10.6 Printer (NKG-900)

⚠ CAUTION



The print head of the NKG-900 printer may be very hot after printing. Do not touch the print head of the printer. Make sure that the print head is cool before replacing the paper or cleaning the print head.



Do not use the NKG-900 printer if there is no ink ribbon cartridge or paper. Do not twist the ink ribbon when installing the ink ribbon cartridge.



To avoid malfunction, do not use the paper feed knob during power on.



Before opening and closing the cover of the NKG-900 printer, turn off the printer. Wait more than 2 seconds after turning the printer off before turning it back on again so it can initialize correctly.

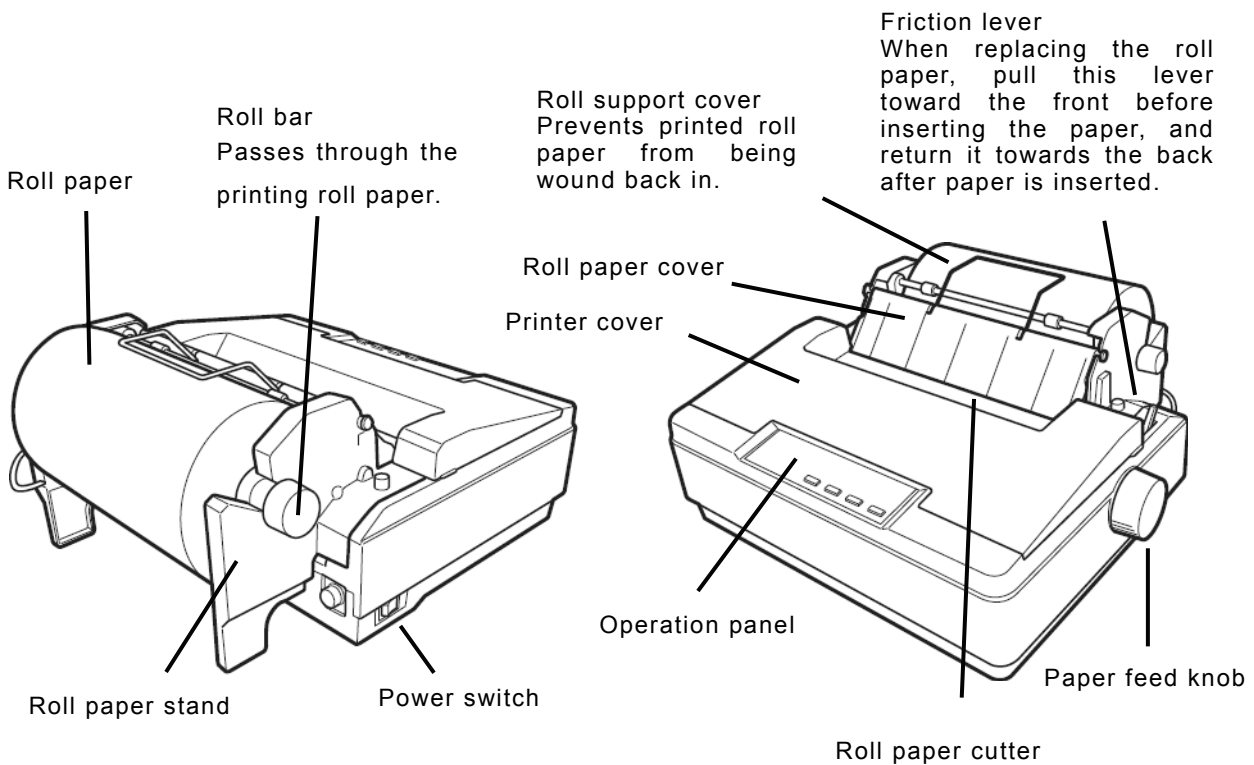

Print head
Contacts the roll paper for printing.

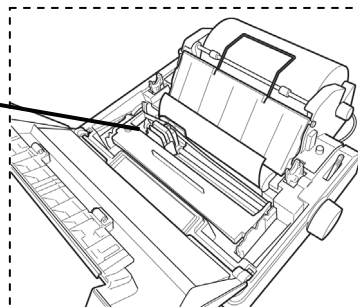

(NKG-900 of the cover opened)

The following shows the functions of the operation panel.

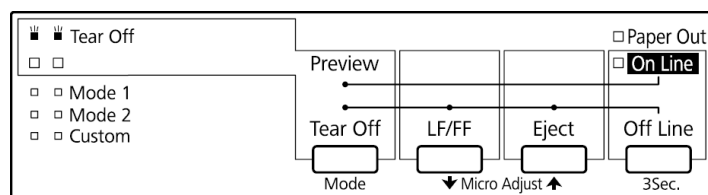

- **On Line** When the On Line lamp is lit, the printer is ready for printing. And the following operation is available in this condition.
 - **Preview** : Feeds the paper some lines temporarily to show the printed lines hidden under the cover. To undo it, repress this key.
- **Off Line** Sets the printer to the offline state if pressing during the online state. During the offline state, the On Line lamp is turned off and the following operations become available. To undo it, repress this key.
 - **Tear Off** : Inserts line feeds to cut the paper at the end of the printed line.
 - **LF/FF** : Feeds the paper one line if pressing a moment or feeds the paper one page if holding down a few seconds.
 - **Eject** : Reverses the paper back out to eject it.

Moreover, to set the printer to the adjustment mode and change the following conditions, hold down the Off Line key for three seconds. To undo it, repress this key for a moment.

 - **Mode** : Selects the Mode1 or Mode2.
Note) Always set to the Mode1. Additionally, the Custom is not accessible.
 - **Micro Adjust** : Fine-tunes the feed length of the Preview.

Note

- When the paper runs low, the Paper Out lamp starts blinking with beeping.
- When the printer runs out of roll paper, the Paper Out lamp lights and the printer automatically goes offline in the same way as the friction lever pulled to the front.
- When pressing the Eject key in the offline state, the Paper Out lamp lights even though still remains the roll paper. In this case, the friction lever or the power switch operation can recover the condition, but to avoid troubles such a paper jam, basically remove the roll paper from the printer.
- Do not cut off the paper just after feeding lines by pressing the Preview key. Always use the Tear Off key when feeding lines to cut off the paper.

■ Loading the printer paper ■

1. Turn the printer OFF, open the printer cover and remove the roll paper cover.

At this step, pull the friction lever towards the front.

Roll paper cover Friction lever

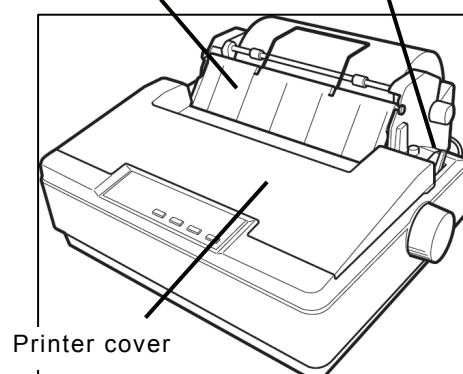

Options Operation

2. Pass the roll bar through the roll paper, and install the roll paper onto the roll paper stand in the right direction.

When passing the roll bar through the roll paper, push the roll bar all the way in.

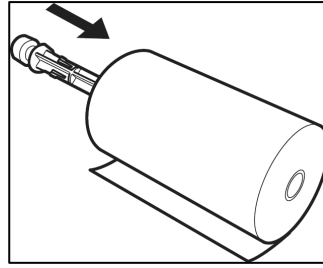

3. Pass the roll paper over the guide bar as shown in the figure at right.

Adjust the side guides to the paper width.

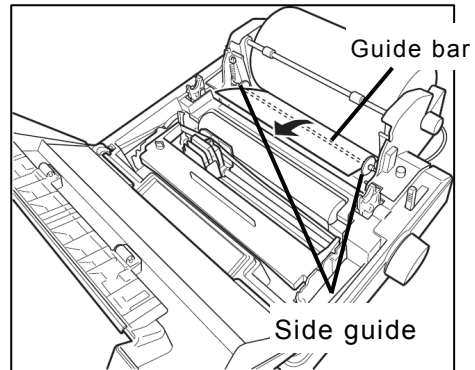

4. Insert the leading edge of the paper into the rear of the platen. Then turn the paper feed knob to feed the paper out and adjust the direction.

After adjusting the paper direction, return the friction lever to the back to fix the paper.

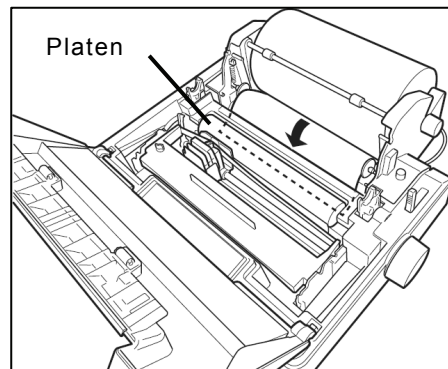

5. Restore the roll paper cover and the roll support cover as shown at right and close the printer cover.

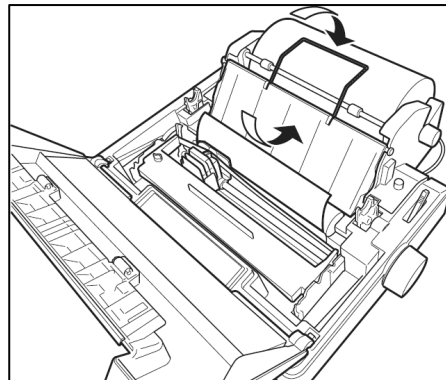

6. Turn on the printer power.

Note

- When turning on the printer holding down the LF/FF key, the print test of alphanumeric characters is started automatically.
- To finish the print test, turn off and on the power.

■ Replacing the ink ribbon ■

1. Turn off the printer and following the same procedure as that in the previous section, open the printer cover, lift up the ink ribbon cartridge by holding the projection on the cartridge, and lift up the cartridge to remove it.

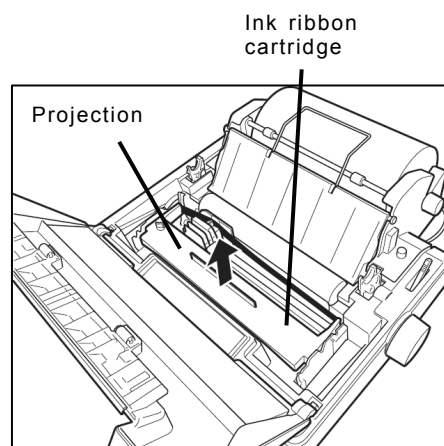

2. Using the knob on the new cartridge make the ribbon taut. Then manually move the print head to the left edge, and attach the ribbon with such a pen so that it is between the ribbon mask and print head.

Note

After attaching the ink ribbon cartridge, check if turning the knob moves the ink ribbon normally.

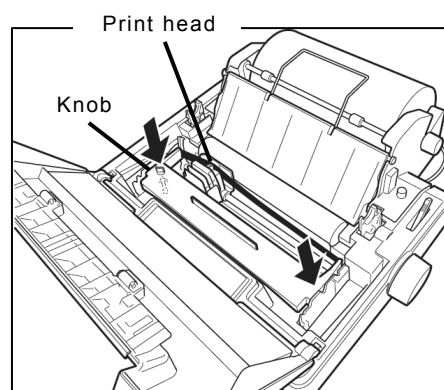

3. Close the printer cover.

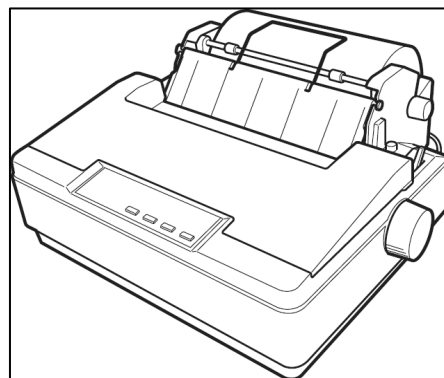

10.7 Operations using a SELCALL unit

The JSS-2150 MF/HF radio equipment can be connected to external selective calling devices for fishing boats (Selcall) to send signals for calling Selcall buoys or Selcall receivers on ships.

Note

For details on operations of the Selcall device, refer to the manuals of that device.

■ Procedure ■

1. Finish all menu operations to return the screen to the status display.

When a transmission is made from the Selcall device while menus are displayed, menus can no longer be operated until transmission ends.

ID 431001234	23:59(UTC)
Pos 89°59.0123'N	179°59.6789'E@23:59 (EXT)
TEL ITU- 401 <small>DUP</small>	
RX 4357.0 kHz	
TX 4065.0 kHz	
SIG ■■■ I I I I I I I I	<small>(S)</small>
WKR scan bands: 2 4 6 8 12 16MHz	NonDST: <small>(MENU)+1</small> DROBOS: <small>(MENU)+2</small> EdtDST: <small>(MENU)+3</small>

2. Set the communication mode to TEL and the assigned frequency (e.g. 2331.5 kHz) for transmitting on the Selcall device in the free frequency input mode. Then tune the antenna by pressing **ANT TUNE** key.

In this case, input both the Rx and Tx frequencies as simplex frequencies.

ID 431001234	23:59(UTC)
Pos 89°59.0123'N	179°59.6789'E@23:59 (EXT)
TEL	SIG ■■■ <small>(S)</small>
RX 2331.5 kHz	WKR 2 4 6 8 12 16
TX 2331.5 kHz	[A] COMM
Communicating on TEL Rx: 2331.5/Tx: 2331.5kHz	
Tip)Use FUNC to change op area. [HLD] [END]	

3. Operate the Selcall device to start transmission.

When transmission is started, the communications mode automatically changes to H2B as shown at right.

ID 431001234	23:59(UTC)
Pos 89°59.0123'N	179°59.6789'E@23:59 (EXT)
H2B	PWR ■■■ <small>(S)</small>
RX 2331.5 kHz	WKR 2 4 6 8 12 16
TX 2331.5 kHz	[A] COMM
Communicating on H2B Rx: 2331.5/Tx: 2331.5kHz	
Tip)Use FUNC to change op area. [HLD] [END]	

4. When transmission ends, the communications mode returns to the original mode.

ID 431001234	23:59(UTC)
Pos 89°59.0123'N	179°59.6789'E@23:59 (EXT)
TEL	SIG ■■■ <small>(S)</small>
RX 2331.5 kHz	WKR 2 4 6 8 12 16
TX 2331.5 kHz	[A] COMM
Communicating on TEL Rx: 2331.5/Tx: 2331.5kHz	
Tip)Use FUNC to change op area. [HLD] [END]	

11. Appendix

This section lists frequencies used for DSC such as frequencies used for routine calls and frequencies used for safety and distress calls. It also lists the channel list of ITU frequencies built-in to this equipment and the instructions for operating the MF/HF radio equipment.

11.1 Frequencies for distress and safety calls

The following is a list of international¹ transmission frequencies (all simplex) used by coast and ship stations for distress and safety purposes either with DSC, radiotelephone or telex. CH No. indicates channel numbers preprogrammed to this equipment.

(DSC)		(radiotelephone)		(telex)	
CH No.	TRx (kHz)	CH No.	TRx (kHz)	CH No.	TRx (kHz)
---	2187.5	---	2182.0	---	2174.5
401	4207.5	---	4125.0	411	4177.5
601	6312.0	---	6215.0	611	6268.0
801	8414.5	833	8291.0	801	8376.5
1201	12577.0	---	12290.0	1287	12520.0
1601	16804.5	---	16420.0	1624	16695.0

Note

- When making DSC calls, the frequencies above can only be used if the message category is Distress, Urgency, or Safety.
- The DSC frequencies listed above are watched by the DSC watch keeping receiver.
- The radiotelephone frequencies other than 8291.0 kHz are the same as the transmission frequencies of ITU channels 421, 606, 1221 and 1621. However, when making calls for distress and safety purposes, use these frequencies² as simplex channels.

¹ RR Appendix 15

² RR Article 52.221.3

11.2 National DSC frequencies for routine calls

When ship and coast stations call national stations for purposes that are not safety or distress purposes, normally use the national frequencies allocated by the administrator prior to using the international frequencies listed later.³ The frequencies for Japan are as follows. Additionally, the pair frequencies are used to make a call to the coast station.

Tx (kHz)	Rx (kHz)	Tx (kHz)	Rx (kHz)	Tx (kHz)	Rx (kHz)
	2169.0	8391.5	8431.5	18872.0	19682.5
4180.5	4218.0	12521.0	12623.0	22318.0	22410.0
6275.5	6326.5	16721.0	16844.0	25175.0	26103.0

11.3 International DSC frequencies for routine calls

The following international⁴ frequencies are used when calling ship and coast stations via DSC if the other station's nationality or the frequency they are watching is not know, except for safety or distress calls. CH No. indicates channel numbers preprogrammed to this equipment.

CH No.	Tx (kHz)	Rx (kHz)	CH No.	Tx (kHz)	Rx (kHz)
---	2189.5	2177.0	1602	16805.0	16903.0
402	4208.0	4219.5	1603	16805.5	16903.5
403	4208.5	4220.0	1604	16806.0	16904.0
404	4209.0	4220.5	1801	18898.5	19703.5
602	6312.5	6331.0	1802	18899.0	19704.0
603	6313.0	6331.5	1803	18899.5	19704.5
604	6313.5	6332.0	2201	22374.5	22444.0
802	8415.0	8436.5	2202	22375.0	22444.5
803	8415.5	8437.0	2203	22375.5	22445.0
804	8416.0	8437.5	2501	25208.5	26121.0
1202	12577.5	12657.0	2502	25209.0	26121.5
1203	12578.0	12657.5	2503	25209.5	26122.0
1204	12578.5	12658.0			

Note

- The above frequencies can only be used when the DSC message category is Routine.
- The above table lists the sending and receiving frequencies (duplex) when a ship station calls a coast station.
- Routine calls between ship stations use 2177.0 kHz as simplex.
- Channels not listed in the table above (401/601/801/1201/1601) are the frequencies listed earlier for distress and safety purposes.
- In the table above, channels 402/602/802/1202/1602/1801/2201/2501 should be selected first when making routine DSC calls on international frequencies.⁵

³ ITU-R M.541-9 Annex 3 4.1.2

⁴ RR Appendix 15

⁵ RR Appendix 17 part A footnote I

11.4 ITU channel list (TEL/CW/TLX)

This section lists the channels preprogrammed into this equipment as TEL, CW and TLX ITU frequencies.

(1) Radiotelephone mode (ITU-RR Appendix 17)

CH No.	Tx (kHz)	Rx (kHz)	Remarks	CH No.	Tx (kHz)	Rx (kHz)	Remarks
401	4065.0	4357.0		607	6218.0	6519.0	
402	4068.0	4360.0		608	6221.0	6522.0	
403	4071.0	4363.0		609	6224.0	6224.0	Simplex ⁽⁺³⁾
404	4074.0	4366.0		610	6227.0	6227.0	Simplex ⁽⁺³⁾
405	4077.0	4369.0		611	6230.0	6230.0	Simplex ⁽⁺³⁾
406	4080.0	4372.0					
407	4083.0	4375.0		801	8195.0	8719.0	
408	4086.0	4378.0		802	8198.0	8722.0	
409	4089.0	4381.0		803	8201.0	8725.0	
410	4092.0	4384.0		804	8204.0	8728.0	
411	4095.0	4387.0		805	8207.0	8731.0	
412	4098.0	4390.0		806	8210.0	8734.0	
413	4101.0	4393.0		807	8213.0	8737.0	
414	4104.0	4396.0		808	8216.0	8740.0	
415	4107.0	4399.0		809	8219.0	8743.0	
416	4110.0	4402.0		810	8222.0	8746.0	
417	4113.0	4405.0		811	8225.0	8749.0	
418	4116.0	4408.0		812	8228.0	8752.0	
419	4119.0	4411.0		813	8231.0	8755.0	
420	4122.0	4414.0		814	8234.0	8758.0	
421	4125.0	4417.0	(+1)(+2)	815	8237.0	8761.0	
422	4128.0	4420.0		816	8240.0	8764.0	
423	4131.0	4423.0		817	8243.0	8767.0	
424	4134.0	4426.0		818	8246.0	8770.0	
425	4137.0	4429.0		819	8249.0	8773.0	
426	4140.0	4432.0		820	8252.0	8776.0	
427	4143.0	4435.0		821	8255.0	8779.0	(+2)
428	4146.0	4146.0	Simplex ⁽⁺⁴⁾	822	8258.0	8782.0	
429	4149.0	4149.0	Simplex ⁽⁺⁵⁾	823	8261.0	8785.0	
				824	8264.0	8788.0	
601	6200.0	6501.0		825	8267.0	8791.0	
602	6203.0	6504.0		826	8270.0	8794.0	
603	6206.0	6507.0		827	8273.0	8797.0	
604	6209.0	6510.0		828	8276.0	8800.0	
605	6212.0	6513.0		829	8279.0	8803.0	
606	6215.0	6516.0	(+1)(+2)	830	8282.0	8806.0	

Appendix

CH No.	Tx (kHz)	Rx (kHz)	Remarks
831	8285.0	8809.0	
832	8288.0	8812.0	
833	8291.0	8291.0	Simplex ^(*1)
834	8294.0	8294.0	Simplex ^(*6)
835	8297.0	8297.0	Simplex ^(*7)
1201	12230.0	13077.0	
1202	12233.0	13080.0	
1203	12236.0	13083.0	
1204	12239.0	13086.0	
1205	12242.0	13089.0	
1206	12245.0	13092.0	
1207	12248.0	13095.0	
1208	12251.0	13098.0	
1209	12254.0	13101.0	
1210	12257.0	13104.0	
1211	12260.0	13107.0	
1212	12263.0	13110.0	
1213	12266.0	13113.0	
1214	12269.0	13116.0	
1215	12272.0	13119.0	
1216	12275.0	13122.0	
1217	12278.0	13125.0	
1218	12281.0	13128.0	
1219	12284.0	13131.0	
1220	12287.0	13134.0	
1221	12290.0	13137.0	(*1) (*8)
1222	12293.0	13140.0	
1223	12296.0	13143.0	
1224	12299.0	13146.0	
1225	12302.0	13149.0	
1226	12305.0	13152.0	
1227	12308.0	13155.0	
1228	12311.0	13158.0	
1229	12314.0	13161.0	
1230	12317.0	13164.0	
1231	12320.0	13167.0	
1232	12323.0	13170.0	
1233	12326.0	13173.0	
1234	12329.0	13176.0	
1235	12332.0	13179.0	
1236	12335.0	13182.0	
1237	12338.0	13185.0	
1238	12341.0	13188.0	

CH No.	Tx (kHz)	Rx (kHz)	Remarks
1239	12344.0	13191.0	
1240	12347.0	13194.0	
1241	12350.0	13197.0	
1242	12353.0	12353.0	Simplex ^(*3)
1243	12356.0	12356.0	Simplex ^(*3)
1244	12359.0	12359.0	Simplex ^(*2)
1245	12362.0	12362.0	Simplex ^(*3)
1246	12365.0	12365.0	Simplex ^(*3)
1601	16360.0	17242.0	
1602	16363.0	17245.0	
1603	16366.0	17248.0	
1604	16369.0	17251.0	
1605	16372.0	17254.0	
1606	16375.0	17257.0	
1607	16378.0	17260.0	
1608	16381.0	17263.0	
1609	16384.0	17266.0	
1610	16387.0	17269.0	
1611	16390.0	17272.0	
1612	16393.0	17275.0	
1613	16396.0	17278.0	
1614	16399.0	17281.0	
1615	16402.0	17284.0	
1616	16405.0	17287.0	
1617	16408.0	17290.0	
1618	16411.0	17293.0	
1619	16414.0	17296.0	
1620	16417.0	17299.0	
1621	16420.0	17302.0	(*1) (*9)
1622	16423.0	17305.0	
1623	16426.0	17308.0	
1624	16429.0	17311.0	
1625	16432.0	17314.0	
1626	16435.0	17317.0	
1627	16438.0	17320.0	
1628	16441.0	17323.0	
1629	16444.0	17326.0	
1630	16447.0	17329.0	
1631	16450.0	17332.0	
1632	16453.0	17335.0	
1633	16456.0	17338.0	
1634	16459.0	17341.0	
1635	16462.0	17344.0	

CH No.	Tx (kHz)	Rx (kHz)	Remarks	CH No.	Tx (kHz)	Rx (kHz)	Remarks
1636	16465.0	17347.0		1816	18825.0	18825.0	Simplex ⁽⁺³⁾
1637	16468.0	17350.0		1817	18828.0	18828.0	Simplex ⁽⁺³⁾
1638	16471.0	17353.0		1818	18831.0	18831.0	Simplex ⁽⁺³⁾
1639	16474.0	17356.0		1819	18834.0	18834.0	Simplex ⁽⁺³⁾
1640	16477.0	17359.0		1820	18837.0	18837.0	Simplex ⁽⁺³⁾
1641	16480.0	17362.0		1821	18840.0	18840.0	Simplex ⁽⁺³⁾
1642	16483.0	17365.0		1822	18843.0	18843.0	Simplex ⁽⁺³⁾
1643	16486.0	17368.0		2201	22000.0	22696.0	
1644	16489.0	17371.0		2202	22003.0	22699.0	
1645	16492.0	17374.0		2203	22006.0	22702.0	
1646	16495.0	17377.0		2204	22009.0	22705.0	
1647	16498.0	17380.0		2205	22012.0	22708.0	
1648	16501.0	17383.0		2206	22015.0	22711.0	
1649	16504.0	17386.0		2207	22018.0	22714.0	
1650	16507.0	17389.0		2208	22021.0	22717.0	
1651	16510.0	17392.0		2209	22024.0	22720.0	
1652	16513.0	17395.0		2210	22027.0	22723.0	
1653	16516.0	17398.0		2211	22030.0	22726.0	
1654	16519.0	17401.0		2212	22033.0	22729.0	
1655	16522.0	17404.0		2213	22036.0	22732.0	
1656	16525.0	17407.0		2214	22039.0	22735.0	
1657	16528.0	16528.0	Simplex ⁽⁺³⁾	2215	22042.0	22738.0	
1658	16531.0	16531.0	Simplex ⁽⁺³⁾	2216	22045.0	22741.0	
1659	16534.0	16534.0	Simplex ⁽⁺³⁾	2217	22048.0	22744.0	
1660	16537.0	16537.0	Simplex ⁽⁺²⁾	2218	22051.0	22747.0	
1661	16540.0	16540.0	Simplex ⁽⁺³⁾	2219	22054.0	22750.0	
1662	16543.0	16543.0	Simplex ⁽⁺³⁾	2220	22057.0	22753.0	
1663	16546.0	16546.0	Simplex ⁽⁺³⁾	2221	22060.0	22756.0	(+2)
1801	18780.0	19755.0		2222	22063.0	22759.0	
1802	18783.0	19758.0		2223	22066.0	22762.0	
1803	18786.0	19761.0		2224	22069.0	22765.0	
1804	18789.0	19764.0		2225	22072.0	22768.0	
1805	18792.0	19767.0		2226	22075.0	22771.0	
1806	18795.0	19770.0	(+2)	2227	22078.0	22774.0	
1807	18798.0	19773.0		2228	22081.0	22777.0	
1808	18801.0	19776.0		2229	22084.0	22780.0	
1809	18804.0	19779.0		2230	22087.0	22783.0	
1810	18807.0	19782.0		2231	22090.0	22786.0	
1811	18810.0	19785.0		2232	22093.0	22789.0	
1812	18813.0	19788.0		2233	22096.0	22792.0	
1813	18816.0	19791.0		2234	22099.0	22795.0	
1814	18819.0	19794.0		2235	22102.0	22798.0	
1815	18822.0	19797.0		2236	22105.0	22801.0	

Appendix

CH No.	Tx (kHz)	Rx (kHz)	Remarks	CH No.	Tx (kHz)	Rx (kHz)	Remarks
2237	22108.0	22804.0		2258	22171.0	22171.0	Simplex ^{(*)3}
2238	22111.0	22807.0		2259	22174.0	22174.0	Simplex ^{(*)3}
2239	22114.0	22810.0		2260	22177.0	22177.0	Simplex ^{(*)3}
2240	22117.0	22813.0					
2241	22120.0	22816.0		2501	25070.0	26145.0	
2242	22123.0	22819.0		2502	25073.0	26148.0	
2243	22126.0	22822.0		2503	25076.0	26151.0	
2244	22129.0	22825.0		2504	25079.0	26154.0	
2245	22132.0	22828.0		2505	25082.0	26157.0	
2246	22135.0	22831.0		2506	25085.0	26160.0	
2247	22138.0	22834.0		2507	25088.0	26163.0	
2248	22141.0	22837.0		2508	25091.0	26166.0	
2249	22144.0	22840.0		2509	25094.0	26169.0	
2250	22147.0	22843.0		2510	25097.0	26172.0	(*)2
2251	22150.0	22846.0		2511	25100.0	25100.0	Simplex ^{(*)3}
2252	22153.0	22849.0		2512	25103.0	25103.0	Simplex ^{(*)3}
2253	22156.0	22852.0		2513	25106.0	25106.0	Simplex ^{(*)3}
2254	22159.0	22159.0	Simplex ^{(*)3}	2514	25109.0	25109.0	Simplex ^{(*)3}
2255	22162.0	22162.0	Simplex ^{(*)3}	2515	25112.0	25112.0	Simplex ^{(*)3}
2256	22165.0	22165.0	Simplex ^{(*)3}	2516	25115.0	25115.0	Simplex ^{(*)3}
2257	22168.0	22168.0	Simplex ^{(*)3}	2517	25118.0	25118.0	Simplex ^{(*)3}

*1) Used for distress and safety purposes (operates duplex channel as simplex).

*2) For calling.

*3) For inter-ship communications.

*4) For inter-ship communications. You can also communicate with coast stations on Rx 4351.0 kHz.

*5) For inter-ship communications. You can also communicate with coast stations on Rx 4354.0 kHz.

*6) For inter-ship communications. You can also communicate with coast stations on Rx 8707.0 kHz.

*7) For inter-ship communications. You can also communicate with coast stations on Rx 8710.0 kHz.

*8) From January 2004, calling on channel 1221 (previously duplex) is prohibited.

*9) From January 2004, calling on channel 1621 (previously duplex) is prohibited.

(2) Additional usable frequencies in TEL mode (ITU-RR Appendix 17 / Sub Section C-1/ C-2)

Tx (kHz)	Rx (kHz)	Remarks	Tx (kHz)	Rx (kHz)	Remarks
4000.0	4000.0	Simplex	8116.0	8116.0	Simplex
4003.0	4003.0	Simplex	8119.0	8119.0	Simplex
4006.0	4006.0	Simplex	8122.0	8122.0	Simplex
4009.0	4009.0	Simplex	8125.0	8125.0	Simplex
4012.0	4012.0	Simplex	8128.0	8128.0	Simplex
4015.0	4015.0	Simplex	8131.0	8131.0	Simplex
4018.0	4018.0	Simplex	8134.0	8134.0	Simplex
4021.0	4021.0	Simplex	8137.0	8137.0	Simplex
4024.0	4024.0	Simplex	8140.0	8140.0	Simplex
4027.0	4027.0	Simplex	8143.0	8143.0	Simplex
4030.0	4030.0	Simplex	8146.0	8146.0	Simplex
4033.0	4033.0	Simplex	8149.0	8149.0	Simplex
4036.0	4036.0	Simplex	8152.0	8152.0	Simplex
4039.0	4039.0	Simplex	8155.0	8155.0	Simplex
4042.0	4042.0	Simplex	8158.0	8158.0	Simplex
4045.0	4045.0	Simplex	8161.0	8161.0	Simplex
4048.0	4048.0	Simplex	8164.0	8164.0	Simplex
4051.0	4051.0	Simplex	8167.0	8167.0	Simplex
4054.0	4054.0	Simplex	8170.0	8170.0	Simplex
4057.0	4057.0	Simplex	8173.0	8173.0	Simplex
4060.0	4060.0	Simplex	8176.0	8176.0	Simplex
			8179.0	8179.0	Simplex
8101.0	8101.0	Simplex	8182.0	8182.0	Simplex
8104.0	8104.0	Simplex	8185.0	8185.0	Simplex
8107.0	8107.0	Simplex	8188.0	8188.0	Simplex
8110.0	8110.0	Simplex	8191.0	8191.0	Simplex
8113.0	8113.0	Simplex			

Appendix

(3) CW mode (ITU-RR Appendix 17)

CH No.	TRx (kHz)	Remarks	CH No.	TRx (kHz)	Remarks	CH No.	TRx (kHz)	Remarks
401	4182.0	Calling	605	6278.0	Calling	809	8370.0	Calling
402	4182.5	Calling	606	6278.5	Calling	810	8370.5	Calling
403	4184.0	Calling	607	6279.0	Calling	811	8342.0	
404	4184.5	Calling	608	6279.5	Calling	812	8342.5	
405	4183.0	Calling	609	6280.0	Calling	813	8343.0	
406	4183.5	Calling	610	6280.5	Calling	814	8343.5	
407	4185.0	Calling	611	6285.0		815	8344.0	
408	4185.5	Calling	612	6285.5		816	8344.5	
409	4186.0	Calling	613	6286.0		817	8345.0	
410	4186.5		614	6286.5		818	8345.5	
411	4187.0		615	6287.0		819	8346.0	
412	4187.5		616	6287.5		820	8346.5	
413	4188.0		617	6288.0		821	8347.0	
414	4188.5		618	6288.5		822	8347.5	
415	4189.0		619	6289.0		823	8348.0	
416	4189.5		620	6289.5		824	8348.5	
417	4190.0		621	6290.0		825	8349.0	
418	4190.5		622	6290.5		826	8349.5	
419	4191.0		623	6291.0		827	8350.0	
420	4191.5		624	6291.5		828	8350.5	
421	4192.0		625	6292.0		829	8351.0	
422	4192.5		626	6292.5		830	8351.5	
423	4193.0		627	6293.0		831	8352.0	
424	4193.5		628	6293.5		832	8352.5	
425	4194.0		629	6294.0		833	8353.0	
426	4194.5		630	6294.5		834	8353.5	
427	4195.0		631	6295.0		835	8354.0	
428	4195.5		632	6295.5		836	8354.5	
429	4196.0		633	6296.0		837	8355.0	
430	4196.5		634	6296.5		838	8355.5	
431	4197.0		635	6297.0		839	8356.0	
432	4197.5		636	6297.5		840	8356.5	
433	4198.0		637	6298.0		841	8357.0	
434	4198.5		638	6298.5		842	8357.5	
435	4199.0		639	6299.0		843	8358.0	
436	4199.5		640	6299.5		844	8358.5	
437	4200.0		641	6300.0		845	8359.0	
438	4200.5					846	8359.5	
439	4201.0		801	8366.0	Calling	847	8360.0	
440	4201.5		802	8366.5	Calling	848	8360.5	
441	4202.0		803	8368.0	Calling	849	8361.0	
			804	8369.0	Calling	850	8361.5	
601	6277.0	Calling	805	8367.0	Calling	851	8362.0	
602	6277.5	Calling	806	8367.5	Calling	852	8362.5	
603	6276.0	Calling	807	8368.5	Calling	853	8363.0	
604	6276.5	Calling	808	8369.5	Calling	854	8363.5	

CH No.	TRx (kHz)	Remarks	CH No.	TRx (kHz)	Remarks	CH No.	TRx (kHz)	Remarks
855	8364.0		1232	12432.5		1279	12456.0	
856	8364.5		1233	12433.0		1280	12456.5	
857	8365.0		1234	12433.5		1281	12457.0	
858	8365.5		1235	12434.0		1282	12457.5	
859	8371.0		1236	12434.5		1283	12458.0	
860	8371.5		1237	12435.0		1284	12458.5	
861	8372.0		1238	12435.5		1285	12459.0	
862	8372.5		1239	12436.0		1286	12459.5	
863	8373.0		1240	12436.5		1287	12460.0	
864	8373.5		1241	12437.0		1288	12460.5	
865	8374.0		1242	12437.5		1289	12461.0	
866	8374.5		1243	12438.0		1290	12461.5	
867	8375.0		1244	12438.5		1291	12462.0	
868	8375.5		1245	12439.0		1292	12462.5	
869	8376.0		1246	12439.5		1293	12463.0	
			1247	12440.0		1294	12463.5	
1201	12550.0	Calling	1248	12440.5		1295	12464.0	
1202	12550.5	Calling	1249	12441.0		1296	12464.5	
1203	12552.0	Calling	1250	12441.5		1297	12465.0	
1204	12553.5	Calling	1251	12442.0		1298	12465.5	
1205	12551.0	Calling	1252	12442.5		1299	12466.0	
1206	12551.5	Calling	1253	12443.0		12100	12466.5	
1207	12552.5	Calling	1254	12443.5		12101	12467.0	
1208	12553.0	Calling	1255	12444.0		12102	12467.5	
1209	12554.0	Calling	1256	12444.5		12103	12468.0	
1210	12554.5	Calling	1257	12445.0		12104	12468.5	
1211	12422.0		1258	12445.5		12105	12469.0	
1212	12422.5		1259	12446.0		12106	12469.5	
1213	12423.0		1260	12446.5		12107	12470.0	
1214	12423.5		1261	12447.0		12108	12470.5	
1215	12424.0		1262	12447.5		12109	12471.0	
1216	12424.5		1263	12448.0		12110	12471.5	
1217	12425.0		1264	12448.5		12111	12472.0	
1218	12425.5		1265	12449.0		12112	12472.5	
1219	12426.0		1266	12449.5		12113	12473.0	
1220	12426.5		1267	12450.0		12114	12473.5	
1221	12427.0		1268	12450.5		12115	12474.0	
1222	12427.5		1269	12451.0		12116	12474.5	
1223	12428.0		1270	12451.5		12117	12475.0	
1224	12428.5		1271	12452.0		12118	12475.5	
1225	12429.0		1272	12452.5		12119	12476.0	
1226	12429.5		1273	12453.0		12120	12476.5	
1227	12430.0		1274	12453.5				
1228	12430.5		1275	12454.0		1601	16734.0	Calling
1229	12431.0		1276	12454.5		1602	16734.5	Calling
1230	12431.5		1277	12455.0		1603	16736.0	Calling
1231	12432.0		1278	12455.5		1604	16738.0	Calling

Appendix

CH No.	TRx (kHz)	Remarks	CH No.	TRx (kHz)	Remarks	CH No.	TRx (kHz)	Remarks
1605	16735.0	Calling	1652	16639.5		1699	16663.0	
1606	16735.5	Calling	1653	16640.0		16100	16663.5	
1607	16736.5	Calling	1654	16640.5		16101	16664.0	
1608	16737.0	Calling	1655	16641.0		16102	16664.5	
1609	16737.5	Calling	1656	16641.5		16103	16665.0	
1610	16738.5	Calling	1657	16642.0		16104	16665.5	
1611	16619.0		1658	16642.5		16105	16666.0	
1612	16619.5		1659	16643.0		16106	16666.5	
1613	16620.0		1660	16643.5		16107	16667.0	
1614	16620.5		1661	16644.0		16108	16667.5	
1615	16621.0		1662	16644.5		16109	16668.0	
1616	16621.5		1663	16645.0		16110	16668.5	
1617	16622.0		1664	16645.5		16111	16669.0	
1618	16622.5		1665	16646.0		16112	16669.5	
1619	16623.0		1666	16646.5		16113	16670.0	
1620	16623.5		1667	16647.0		16114	16670.5	
1621	16624.0		1668	16647.5		16115	16671.0	
1622	16624.5		1669	16648.0		16116	16671.5	
1623	16625.0		1670	16648.5		16117	16672.0	
1624	16625.5		1671	16649.0		16118	16672.5	
1625	16626.0		1672	16649.5		16119	16673.0	
1626	16626.5		1673	16650.0		16120	16673.5	
1627	16627.0		1674	16650.5		16121	16674.0	
1628	16627.5		1675	16651.0		16122	16674.5	
1629	16628.0		1676	16651.5		16123	16675.0	
1630	16628.5		1677	16652.0		16124	16675.5	
1631	16629.0		1678	16652.5		16125	16676.0	
1632	16629.5		1679	16653.0		16126	16676.5	
1633	16630.0		1680	16653.5		16127	16677.0	
1634	16630.5		1681	16654.0		16128	16677.5	
1635	16631.0		1682	16654.5		16129	16678.0	
1636	16631.5		1683	16655.0		16130	16678.5	
1637	16632.0		1684	16655.5		16131	16679.0	
1638	16632.5		1685	16656.0		16132	16679.5	
1639	16633.0		1686	16656.5		16133	16680.0	
1640	16633.5		1687	16657.0		16134	16680.5	
1641	16634.0		1688	16657.5		16135	16681.0	
1642	16634.5		1689	16658.0		16136	16681.5	
1643	16635.0		1690	16658.5		16137	16682.0	
1644	16635.5		1691	16659.0		16138	16682.5	
1645	16636.0		1692	16659.5		16139	16683.0	
1646	16636.5		1693	16660.0				
1647	16637.0		1694	16660.5		2201	22279.5	Calling
1648	16637.5		1695	16661.0		2202	22280.0	Calling
1649	16638.0		1696	16661.5		2203	22280.5	Calling
1650	16638.5		1697	16662.0		2204	22281.0	Calling
1651	16639.0		1698	16662.5		2205	22281.5	Calling

CH No.	TRx (kHz)	Remarks	CH No.	TRx (kHz)	Remarks	CH No.	TRx (kHz)	Remarks
2206	22282.0	Calling	2241	22257.0		2276	22274.5	
2207	22282.5	Calling	2242	22257.5		2277	22275.0	
2208	22283.0	Calling	2243	22258.0		2278	22275.5	
2209	22283.5	Calling	2244	22258.5		2279	22276.0	
2210	22284.0	Calling	2245	22259.0		2280	22276.5	
2211	22242.0		2246	22259.5		2281	22277.0	
2212	22242.5		2247	22260.0		2282	22277.5	
2213	22243.0		2248	22260.5		2283	22278.0	
2214	22243.5		2249	22261.0		2284	22278.5	
2215	22244.0		2250	22261.5		2285	22279.0	
2216	22244.5		2251	22262.0				
2217	22245.0		2252	22262.5		2501	25171.5	Calling
2218	22245.5		2253	22263.0		2502	25172.0	Calling
2219	22246.0		2254	22263.5		2503	25171.5	Calling
2220	22246.5		2255	22264.0		2504	25172.5	Calling
2221	22247.0		2256	22264.5		2505	25161.5	
2222	22247.5		2257	22265.0		2506	25162.0	
2223	22248.0		2258	22265.5		2507	25162.5	
2224	22248.5		2259	22266.0		2508	25163.0	
2225	22249.0		2260	22266.5		2509	25163.5	
2226	22249.5		2261	22267.0		2510	25164.0	
2227	22250.0		2262	22267.5		2511	25164.5	
2228	22250.5		2263	22268.0		2512	25165.0	
2229	22251.0		2264	22268.5		2513	25165.5	
2230	22251.5		2265	22269.0		2514	25166.0	
2231	22252.0		2266	22269.5		2515	25166.5	
2232	22252.5		2267	22270.0		2516	25167.0	
2233	22253.0		2268	22270.5		2517	25167.5	
2234	22253.5		2269	22271.0		2518	25168.0	
2235	22254.0		2270	22271.5		2519	25168.5	
2236	22254.5		2271	22272.0		2520	25169.0	
2237	22255.0		2272	22272.5		2521	25169.5	
2238	22255.5		2273	22273.0		2522	25170.0	
2239	22256.0		2274	22273.5		2523	25170.5	
2240	22256.5		2275	22274.0		2524	25171.0	

Appendix

(4) Telex mode (ITU-RR Appendix 17)

CH No.	Tx (kHz)	Rx (kHz)	Remarks
401	4172.5	4210.5	
402	4173.0	4211.0	
403	4173.5	4211.5	
404	4174.0	4212.0	
405	4174.5	4212.5	
406	4175.0	4213.0	
407	4175.5	4213.5	
408	4176.0	4214.0	
409	4176.5	4214.5	
410	4177.0	4215.0	
411	4177.5	4177.5	Simplex ^(*)
412	4178.0	4215.5	
413	4178.5	4216.0	
414	4179.0	4216.5	
415	4179.5	4217.0	
416	4180.0	4217.5	
417	4180.5	4218.0	
418	4181.0	4218.5	
419	4181.5	4219.0	
420	4202.5	4202.5	Simplex
421	4203.0	4203.0	Simplex
422	4203.5	4203.5	Simplex
423	4204.0	4204.0	Simplex
424	4204.5	4204.5	Simplex
425	4205.0	4205.0	Simplex
426	4205.5	4205.5	Simplex
427	4206.0	4206.0	Simplex
428	4206.5	4206.5	Simplex
429	4207.0	4207.0	Simplex
601	6263.0	6314.5	
602	6263.5	6315.0	
603	6264.0	6315.5	
604	6264.5	6316.0	
605	6265.0	6316.5	
606	6265.5	6317.0	
607	6266.0	6317.5	
608	6266.5	6318.0	
609	6267.0	6318.5	
610	6267.5	6319.0	
611	6268.0	6268.0	Simplex ^(*)
612	6268.5	6319.5	
613	6269.0	6320.0	

CH No.	Tx (kHz)	Rx (kHz)	Remarks
614	6269.5	6320.5	
615	6270.0	6321.0	
616	6270.5	6321.5	
617	6271.0	6322.0	
618	6271.5	6322.5	
619	6272.0	6323.0	
620	6272.5	6323.5	
621	6273.0	6324.0	
622	6273.5	6324.5	
623	6274.0	6325.0	
624	6274.5	6325.5	
625	6275.0	6326.0	
626	6275.5	6326.5	
627	6281.0	6327.0	
628	6281.5	6327.5	
629	6282.0	6328.0	
630	6282.5	6328.5	
631	6283.0	6329.0	
632	6283.5	6329.5	
633	6284.0	6330.0	
634	6284.5	6330.5	
635	6300.5	6300.5	Simplex
636	6301.0	6301.0	Simplex
637	6301.5	6301.5	Simplex
638	6302.0	6302.0	Simplex
639	6302.5	6302.5	Simplex
640	6303.0	6303.0	Simplex
641	6303.5	6303.5	Simplex
642	6304.0	6304.0	Simplex
643	6304.5	6304.5	Simplex
644	6305.0	6305.0	Simplex
645	6305.5	6305.5	Simplex
646	6306.0	6306.0	Simplex
647	6306.5	6306.5	Simplex
648	6307.0	6307.0	Simplex
649	6307.5	6307.5	Simplex
650	6308.0	6308.0	Simplex
651	6308.5	6308.5	Simplex
652	6309.0	6309.0	Simplex
653	6309.5	6309.5	Simplex
654	6310.0	6310.0	Simplex
655	6310.5	6310.5	Simplex
656	6311.0	6311.0	Simplex

CH No.	Tx (kHz)	Rx (kHz)	Remarks
657	6311.5	6311.5	Simplex
801	8376.5	8376.5	Simplex ^(*)
802	8377.0	8417.0	
803	8377.5	8417.5	
804	8378.0	8418.0	
805	8378.5	8418.5	
806	8379.0	8419.0	
807	8379.5	8419.5	
808	8380.0	8420.0	
809	8380.5	8420.5	
810	8381.0	8421.0	
811	8381.5	8421.5	
812	8382.0	8422.0	
813	8382.5	8422.5	
814	8383.0	8423.0	
815	8383.5	8423.5	
816	8384.0	8424.0	
817	8384.5	8424.5	
818	8385.0	8425.0	
819	8385.5	8425.5	
820	8386.0	8426.0	
821	8386.5	8426.5	
822	8387.0	8427.0	
823	8387.5	8427.5	
824	8388.0	8428.0	
825	8388.5	8428.5	
826	8389.0	8429.0	
827	8389.5	8429.5	
828	8390.0	8430.0	
829	8390.5	8430.5	
830	8391.0	8431.0	
831	8391.5	8431.5	
832	8392.0	8432.0	
833	8392.5	8432.5	
834	8393.0	8433.0	
835	8393.5	8433.5	
836	8394.0	8434.0	
837	8394.5	8434.5	
838	8395.0	8435.0	
839	8395.5	8435.5	
840	8396.0	8436.0	
841	8396.5	8396.5	Simplex
842	8397.0	8397.0	Simplex

CH No.	Tx (kHz)	Rx (kHz)	Remarks
843	8397.5	8397.5	Simplex
844	8398.0	8398.0	Simplex
845	8398.5	8398.5	Simplex
846	8399.0	8399.0	Simplex
847	8399.5	8399.5	Simplex
848	8400.0	8400.0	Simplex
849	8400.5	8400.5	Simplex
850	8401.0	8401.0	Simplex
851	8401.5	8401.5	Simplex
852	8402.0	8402.0	Simplex
853	8402.5	8402.5	Simplex
854	8403.0	8403.0	Simplex
855	8403.5	8403.5	Simplex
856	8404.0	8404.0	Simplex
857	8404.5	8404.5	Simplex
858	8405.0	8405.0	Simplex
859	8405.5	8405.5	Simplex
860	8406.0	8406.0	Simplex
861	8406.5	8406.5	Simplex
862	8407.0	8407.0	Simplex
863	8407.5	8407.5	Simplex
864	8408.0	8408.0	Simplex
865	8408.5	8408.5	Simplex
866	8409.0	8409.0	Simplex
867	8409.5	8409.5	Simplex
868	8410.0	8410.0	Simplex
869	8410.5	8410.5	Simplex
870	8411.0	8411.0	Simplex
871	8411.5	8411.5	Simplex
872	8412.0	8412.0	Simplex
873	8412.5	8412.5	Simplex
874	8413.0	8413.0	Simplex
875	8413.5	8413.5	Simplex
876	8414.0	8414.0	Simplex
1201	12477.0	12579.5	
1202	12477.5	12580.0	
1203	12478.0	12580.5	
1204	12478.5	12581.0	
1205	12479.0	12581.5	
1206	12479.5	12582.0	
1207	12480.0	12582.5	
1208	12480.5	12583.0	
1209	12481.0	12583.5	

Appendix

CH No.	Tx (kHz)	Rx (kHz)	Remarks
1210	12481.5	12584.0	
1211	12482.0	12584.5	
1212	12482.5	12585.0	
1213	12483.0	12585.5	
1214	12483.5	12586.0	
1215	12484.0	12586.5	
1216	12484.5	12587.0	
1217	12485.0	12587.5	
1218	12485.5	12588.0	
1219	12486.0	12588.5	
1220	12486.5	12589.0	
1221	12487.0	12589.5	
1222	12487.5	12590.0	
1223	12488.0	12590.5	
1224	12488.5	12591.0	
1225	12489.0	12591.5	
1226	12489.5	12592.0	
1227	12490.0	12592.5	
1228	12490.5	12593.0	
1229	12491.0	12593.5	
1230	12491.5	12594.0	
1231	12492.0	12594.5	
1232	12492.5	12595.0	
1233	12493.0	12595.5	
1234	12493.5	12596.0	
1235	12494.0	12596.5	
1236	12494.5	12597.0	
1237	12495.0	12597.5	
1238	12495.5	12598.0	
1239	12496.0	12598.5	
1240	12496.5	12599.0	
1241	12497.0	12599.5	
1242	12497.5	12600.0	
1243	12498.0	12600.5	
1244	12498.5	12601.0	
1245	12499.0	12601.5	
1246	12499.5	12602.0	
1247	12500.0	12602.5	
1248	12500.5	12603.0	
1249	12501.0	12603.5	
1250	12501.5	12604.0	
1251	12502.0	12604.5	
1252	12502.5	12605.0	
1253	12503.0	12605.5	

CH No.	Tx (kHz)	Rx (kHz)	Remarks
1254	12503.5	12606.0	
1255	12504.0	12606.5	
1256	12504.5	12607.0	
1257	12505.0	12607.5	
1258	12505.5	12608.0	
1259	12506.0	12608.5	
1260	12506.5	12609.0	
1261	12507.0	12609.5	
1262	12507.5	12610.0	
1263	12508.0	12610.5	
1264	12508.5	12611.0	
1265	12509.0	12611.5	
1266	12509.5	12612.0	
1267	12510.0	12612.5	
1268	12510.5	12613.0	
1269	12511.0	12613.5	
1270	12511.5	12614.0	
1271	12512.0	12614.5	
1272	12512.5	12615.0	
1273	12513.0	12615.5	
1274	12513.5	12616.0	
1275	12514.0	12616.5	
1276	12514.5	12617.0	
1277	12515.0	12617.5	
1278	12515.5	12618.0	
1279	12516.0	12618.5	
1280	12516.5	12619.0	
1281	12517.0	12619.5	
1282	12517.5	12620.0	
1283	12518.0	12620.5	
1284	12518.5	12621.0	
1285	12519.0	12621.5	
1286	12519.5	12622.0	
1287	12520.0	12520.0	Simplex ⁽¹⁾
1288	12520.5	12622.5	
1289	12521.0	12623.0	
1290	12521.5	12623.5	
1291	12522.0	12624.0	
1292	12522.5	12624.5	
1293	12523.0	12625.0	
1294	12523.5	12625.5	
1295	12524.0	12626.0	
1296	12524.5	12626.5	
1297	12525.0	12627.0	

CH No.	Tx (kHz)	Rx (kHz)	Remarks
1298	12525.5	12627.5	
1299	12526.0	12628.0	
12100	12526.5	12628.5	
12101	12527.0	12629.0	
12102	12527.5	12629.5	
12103	12528.0	12630.0	
12104	12528.5	12630.5	
12105	12529.0	12631.0	
12106	12529.5	12631.5	
12107	12530.0	12632.0	
12108	12530.5	12632.5	
12109	12531.0	12633.0	
12110	12531.5	12633.5	
12111	12532.0	12634.0	
12112	12532.5	12634.5	
12113	12533.0	12635.0	
12114	12533.5	12635.5	
12115	12534.0	12636.0	
12116	12534.5	12636.5	
12117	12535.0	12637.0	
12118	12535.5	12637.5	
12119	12536.0	12638.0	
12120	12536.5	12638.5	
12121	12537.0	12639.0	
12122	12537.5	12639.5	
12123	12538.0	12640.0	
12124	12538.5	12640.5	
12125	12539.0	12641.0	
12126	12539.5	12641.5	
12127	12540.0	12642.0	
12128	12540.5	12642.5	
12129	21541.0	12643.0	
12130	12541.5	12643.5	
12131	12542.0	12644.0	
12132	12542.5	12644.5	
12133	12543.0	12645.0	
12134	12543.5	12645.5	
12135	12544.0	12646.0	
12136	12544.5	12646.5	
12137	12545.0	12647.0	
12138	12545.5	12647.5	
12139	12546.0	12648.0	
12140	12546.5	12648.5	
12141	12547.0	12649.0	

CH No.	Tx (kHz)	Rx (kHz)	Remarks
12142	12547.5	12649.5	
12143	12548.0	12650.0	
12144	12548.5	12650.5	
12145	12549.0	12651.0	
12146	12549.5	12651.5	
12147	12555.0	12652.0	
12148	12555.5	12652.5	
12149	12556.0	12653.0	
12150	12556.5	12653.5	
12151	12557.0	12654.0	
12152	12557.5	12654.5	
12153	12558.0	12655.0	
12154	12558.5	12655.5	
12155	12559.0	12656.0	
12156	12559.5	12656.5	
12157	12560.0	12560.0	Simplex
12158	12560.5	12560.5	Simplex
12159	12561.0	12561.0	Simplex
12160	21561.5	12561.5	Simplex
12161	12562.0	12562.0	Simplex
12162	12562.5	12562.5	Simplex
12163	12563.0	12563.0	Simplex
12164	12563.5	12563.5	Simplex
12165	12564.0	12564.0	Simplex
12166	12564.5	12564.5	Simplex
12167	12565.0	12565.0	Simplex
12168	12565.5	12565.5	Simplex
12169	12566.0	12566.0	Simplex
12170	12566.5	12566.5	Simplex
12171	12567.0	12567.0	Simplex
12172	12567.5	12567.5	Simplex
12173	12568.0	12568.0	Simplex
12174	12568.5	12568.5	Simplex
12175	12569.0	12569.0	Simplex
12176	12569.5	12569.5	Simplex
12177	12570.0	12570.0	Simplex
12178	12570.5	12570.5	Simplex
12179	12571.0	12571.0	Simplex
12180	12571.5	12571.5	Simplex
12181	12572.0	12572.0	Simplex
12182	12572.5	12572.5	Simplex
12183	12573.0	12573.0	Simplex
12184	12573.5	12573.5	Simplex
12185	12574.0	12574.0	Simplex

Appendix

CH No.	Tx (kHz)	Rx (kHz)	Remarks
12186	12574.5	12574.5	Simplex
12187	12575.0	12575.0	Simplex
12188	12575.5	12575.5	Simplex
12189	12576.0	12576.0	Simplex
12190	12576.5	12576.5	Simplex
1601	16683.5	16807.0	
1602	16684.0	16807.5	
1603	16684.5	16808.0	
1604	16685.0	16808.5	
1605	16685.5	16809.0	
1606	16686.0	16809.5	
1607	16686.5	16810.0	
1608	16687.0	16810.5	
1609	16687.5	16811.0	
1610	16688.0	16811.5	
1611	16688.5	16812.0	
1612	16689.0	16812.5	
1613	16689.5	16813.0	
1614	16690.0	16813.5	
1615	16690.5	16814.0	
1616	16691.0	16814.5	
1617	16691.5	16815.0	
1618	16692.0	16815.5	
1619	16692.5	16816.0	
1620	16693.0	16816.5	
1621	16693.5	16817.0	
1622	16694.0	16817.5	
1623	16694.5	16818.0	
1624	16695.0	16695.0	Simplex ^(*)
1625	16695.5	16818.5	
1626	16696.0	16819.0	
1627	16696.5	16819.5	
1628	16697.0	16820.0	
1629	16697.5	16820.5	
1630	16698.0	16821.0	
1631	16698.5	16821.5	
1632	16699.0	16822.0	
1633	16699.5	16822.5	
1634	16700.0	16823.0	
1635	16700.5	16823.5	
1636	16701.0	16824.0	
1637	16701.5	16824.5	
1638	16702.0	16825.0	

CH No.	Tx (kHz)	Rx (kHz)	Remarks
1639	16702.5	16825.5	
1640	16703.0	16826.0	
1641	16703.5	16826.5	
1642	16704.0	16827.0	
1643	16704.5	16827.5	
1644	16705.0	16828.0	
1645	16705.5	16828.5	
1646	16706.0	16829.0	
1647	16706.5	16829.5	
1648	16707.0	16830.0	
1649	16707.5	16830.5	
1650	16708.0	16831.0	
1651	16708.5	16831.5	
1652	16709.0	16832.0	
1653	16709.5	16832.5	
1654	16710.0	16833.0	
1655	16710.5	16833.5	
1656	16711.0	16834.0	
1657	16711.5	16834.5	
1658	16712.0	16835.0	
1659	16712.5	16835.5	
1660	16713.0	16836.0	
1661	16713.5	16836.5	
1662	16714.0	16837.0	
1663	16714.5	16837.5	
1664	16715.0	16838.0	
1665	16715.5	16838.5	
1666	16716.0	16839.0	
1667	16716.5	16839.5	
1668	16717.0	16840.0	
1669	16717.5	16840.5	
1670	16718.0	16841.0	
1671	16718.5	16841.5	
1672	16719.0	16842.0	
1673	16719.5	16842.5	
1674	16720.0	16843.0	
1675	16720.5	16843.5	
1676	16721.0	16844.0	
1677	16721.5	16844.5	
1678	16722.0	16845.0	
1679	16722.5	16845.5	
1680	16723.0	16846.0	
1681	16723.5	16846.5	
1682	16724.0	16847.0	

CH No.	Tx (kHz)	Rx (kHz)	Remarks
1683	16724.5	16847.5	
1684	16725.0	16848.0	
1685	16725.5	16848.5	
1686	16726.0	16849.0	
1687	16726.5	16849.5	
1688	16727.0	16850.0	
1689	16727.5	16850.5	
1690	16728.0	16851.0	
1691	16728.5	16851.5	
1692	16729.0	16852.0	
1693	16729.5	16852.5	
1694	16730.0	16853.0	
1695	16730.5	16853.5	
1696	16731.0	16854.0	
1697	16731.5	16854.5	
1698	16732.0	16855.0	
1699	16732.5	16855.5	
16100	16733.0	16856.0	
16101	16733.5	16856.5	
16102	16739.0	16857.0	
16103	16739.5	16857.5	
16104	16740.0	16858.0	
16105	16740.5	16858.5	
16106	16741.0	16859.0	
16107	16741.5	16859.5	
16108	16742.0	16860.0	
16109	16742.5	16860.5	
16110	16743.0	16861.0	
16111	16743.5	16861.5	
16112	16744.0	16862.0	
16113	16744.5	16862.5	
16114	16745.0	16863.0	
16115	16745.5	16863.5	
16116	16746.0	16864.0	
16117	16746.5	16864.5	
16118	16747.0	16865.0	
16119	16747.5	16865.5	
16120	16748.0	16866.0	
16121	16748.5	16866.5	
16122	16749.0	16867.0	
16123	16749.5	16867.5	
16124	16750.0	16868.0	
16125	16750.5	16868.5	
16126	16751.0	16869.0	

CH No.	Tx (kHz)	Rx (kHz)	Remarks
16127	16751.5	16869.5	
16128	16752.0	16870.0	
16129	16752.5	16870.5	
16130	16753.0	16871.0	
16131	16753.5	16871.5	
16132	16754.0	16872.0	
16133	16754.5	16872.5	
16134	16755.0	16873.0	
16135	16755.5	16873.5	
16136	16756.0	16874.0	
16137	16756.5	16874.5	
16138	16757.0	16875.0	
16139	16757.5	16875.5	
16140	16758.0	16876.0	
16141	16758.5	16876.5	
16142	16759.0	16877.0	
16143	16759.5	16877.5	
16144	16760.0	16878.0	
16145	16760.5	16878.5	
16146	16761.0	16879.0	
16147	16761.5	16879.5	
16148	16762.0	16880.0	
16149	16762.5	16880.5	
16150	16763.0	16881.0	
16151	16763.5	16881.5	
16152	16764.0	16882.0	
16153	16764.5	16882.5	
16154	16765.0	16883.0	
16155	16765.5	16883.5	
16156	16766.0	16884.0	
16157	16766.5	16884.5	
16158	16767.0	16885.0	
16159	16767.5	16885.5	
16160	16768.0	16886.0	
16161	16768.5	16886.5	
16162	16769.0	16887.0	
16163	16769.5	16887.5	
16164	16770.0	16888.0	
16165	16770.5	16888.5	
16166	16771.0	16889.0	
16167	16771.5	16889.5	
16168	16772.0	16890.0	
16169	16772.5	16890.5	
16170	16773.0	16891.0	

Appendix

CH No.	Tx (kHz)	Rx (kHz)	Remarks
16171	16773.5	16891.5	
16172	16774.0	16892.0	
16173	16774.5	16892.5	
16174	16775.0	16893.0	
16175	16775.5	16893.5	
16176	16776.0	16894.0	
16177	16776.5	16894.5	
16178	16777.0	16895.0	
16179	16777.5	16895.5	
16180	16778.0	16896.0	
16181	16778.5	16896.5	
16182	16779.0	16897.0	
16183	16779.5	16897.5	
16184	16780.0	16898.0	
16185	16780.5	16898.5	
16186	16781.0	16899.0	
16187	16781.5	16899.5	
16188	16782.0	16900.0	
16189	16782.5	16900.5	
16190	16783.0	16901.0	
16191	16783.5	16901.5	
16192	16784.0	16902.0	
16193	16784.5	16902.5	
16194	16785.0	16785.0	Simplex
16195	16785.5	16785.5	Simplex
16196	16786.0	16786.0	Simplex
16197	16786.5	16786.5	Simplex
16198	16787.0	16787.0	Simplex
16199	16787.5	16787.5	Simplex
16200	16788.0	16788.0	Simplex
16201	16788.5	16788.5	Simplex
16202	16789.0	16789.0	Simplex
16203	16789.5	16789.5	Simplex
16204	16790.0	16790.0	Simplex
16205	16790.5	16790.5	Simplex
16206	16791.0	16791.0	Simplex
16207	16791.5	16791.5	Simplex
16208	16792.0	16792.0	Simplex
16209	16792.5	16792.5	Simplex
16210	16793.0	16793.0	Simplex
16211	16793.5	16793.5	Simplex
16212	16794.0	16794.0	Simplex
16213	16794.5	16794.5	Simplex
16214	16795.0	16795.0	Simplex

CH No.	Tx (kHz)	Rx (kHz)	Remarks
16215	16795.5	16795.5	Simplex
16216	16796.0	16796.0	Simplex
16217	16796.5	16796.5	Simplex
16218	16797.0	16797.0	Simplex
16219	16797.5	16797.5	Simplex
16220	16798.0	16798.0	Simplex
16221	16798.5	16798.5	Simplex
16222	16799.0	16799.0	Simplex
16223	16799.5	16799.5	Simplex
16224	16800.0	16800.0	Simplex
16225	16800.5	16800.5	Simplex
16226	16801.0	16801.0	Simplex
16227	16801.5	16801.5	Simplex
16228	16802.0	16802.0	Simplex
16229	16802.5	16802.5	Simplex
16230	16803.0	16803.0	Simplex
16231	16803.5	16803.5	Simplex
16232	16804.0	16804.0	Simplex
1801	18870.5	19681.0	
1802	18871.0	19681.5	
1803	18871.5	19682.0	
1804	18872.0	19682.5	
1805	18872.5	19683.0	
1806	18873.0	19683.5	
1807	18873.5	19684.0	
1808	18874.0	19684.5	
1809	18874.5	19685.0	
1810	18875.0	19685.5	
1811	18875.5	19686.0	
1812	18876.0	19686.5	
1813	18876.5	19687.0	
1814	18877.0	19687.5	
1815	18877.5	19688.0	
1816	18878.0	19688.5	
1817	18878.5	19689.0	
1818	18879.0	19689.5	
1819	18879.5	19690.0	
1820	18880.0	19690.5	
1821	18880.5	19691.0	
1822	18881.0	19691.5	
1823	18881.5	19692.0	
1824	18882.0	19692.5	
1825	18882.5	19693.0	

CH No.	Tx (kHz)	Rx (kHz)	Remarks
1826	18883.0	19693.5	
1827	18883.5	19694.0	
1828	18884.0	19694.5	
1829	18884.5	19695.0	
1830	18885.0	19695.5	
1831	18885.5	19696.0	
1832	18886.0	19696.5	
1833	18886.5	19697.0	
1834	18887.0	19697.5	
1835	18887.5	19698.0	
1836	18888.0	19698.5	
1837	18888.5	19699.0	
1838	18889.0	19699.5	
1839	18889.5	19700.0	
1840	18890.0	19700.5	
1841	18890.5	19701.0	
1842	18891.0	19701.5	
1843	18891.5	19702.0	
1844	18892.0	19702.5	
1845	18892.5	19703.0	
1846	18893.0	18893.0	Simplex
1847	18893.5	18893.5	Simplex
1848	18894.0	18894.0	Simplex
1849	18894.5	18894.5	Simplex
1850	18895.0	18895.0	Simplex
1851	18895.5	18895.5	Simplex
1852	18896.0	18896.0	Simplex
1853	18896.5	18896.5	Simplex
1854	18897.0	18897.0	Simplex
1855	18897.5	18897.5	Simplex
1856	18898.0	18898.0	Simplex
2201	22284.5	22376.5	
2202	22285.0	22377.0	
2203	22285.5	22377.5	
2204	22286.0	22378.0	
2205	22286.5	22378.5	
2206	22287.0	22379.0	
2207	22287.5	22379.5	
2208	22288.0	22380.0	
2209	22288.5	22380.5	
2210	22289.0	22381.0	
2211	22289.5	22381.5	
2212	22290.0	22382.0	

CH No.	Tx (kHz)	Rx (kHz)	Remarks
2213	22290.5	22382.5	
2214	22291.0	22383.0	
2215	22291.5	22383.5	
2216	22292.0	22384.0	
2217	22292.5	22384.5	
2218	22293.0	22385.0	
2219	22293.5	22385.5	
2220	22294.0	22386.0	
2221	22294.5	22386.5	
2222	22295.0	22387.0	
2223	22295.5	22387.5	
2224	22296.0	22388.0	
2225	22296.5	22388.5	
2226	22297.0	22389.0	
2227	22297.5	22389.5	
2228	22298.0	22390.0	
2229	22298.5	22390.5	
2230	22299.0	22391.0	
2231	22299.5	22391.5	
2232	22300.0	22392.0	
2233	22300.5	22392.5	
2234	22301.0	22393.0	
2235	22301.5	22393.5	
2236	22302.0	22394.0	
2237	22302.5	22394.5	
2238	22303.0	22395.0	
2239	22303.5	22395.5	
2240	22304.0	22396.0	
2241	22304.5	22396.5	
2242	22305.0	22397.0	
2243	22305.5	22397.5	
2244	22306.0	22398.0	
2245	22306.5	22398.5	
2246	22307.0	22399.0	
2247	22307.5	22399.5	
2248	22308.0	22400.0	
2249	22308.5	22400.5	
2250	22309.0	22401.0	
2251	22309.5	22401.5	
2252	22310.0	22402.0	
2253	22310.5	22402.5	
2254	22311.0	22403.0	
2255	22311.5	22403.5	
2256	22312.0	22404.0	

Appendix

CH No.	Tx (kHz)	Rx (kHz)	Remarks
2257	22312.5	22404.5	
2258	22313.0	22405.0	
2259	22313.5	22405.5	
2260	22314.0	22406.0	
2261	22314.5	22406.5	
2262	22315.0	22407.0	
2263	22315.5	22407.5	
2264	22316.0	22408.0	
2265	22316.5	22408.5	
2266	22317.0	22409.0	
2267	22317.5	22409.5	
2268	22318.0	22410.0	
2269	22318.5	22410.5	
2270	22319.0	22411.0	
2271	22319.5	22411.5	
2272	22320.0	22412.0	
2273	22320.5	22412.5	
2274	22321.0	22413.0	
2275	22321.5	22413.5	
2276	22322.0	22414.0	
2277	22322.5	22414.5	
2278	22323.0	22415.0	
2279	22323.5	22415.5	
2280	22324.0	22416.0	
2281	22324.5	22416.5	
2282	22325.0	22417.0	
2283	22325.5	22417.5	
2284	22326.0	22418.0	
2285	22326.5	22418.5	
2286	22327.0	22419.0	
2287	22327.5	22419.5	
2288	22328.0	22420.0	
2289	22328.5	22420.5	
2290	22329.0	22421.0	
2291	22329.5	22421.5	
2292	22330.0	22422.0	
2293	22330.5	22422.5	
2294	22331.0	22423.0	
2295	22331.5	22423.5	
2296	22332.0	22424.0	
2297	22332.5	22424.5	
2298	22333.0	22425.0	
2299	22333.5	22425.5	
22100	22334.0	22426.0	

CH No.	Tx (kHz)	Rx (kHz)	Remarks
22101	22334.5	22426.5	
22102	22335.0	22427.0	
22103	22335.5	22427.5	
22104	22336.0	22428.0	
22105	22336.5	22428.5	
22106	22337.0	22429.0	
22107	22337.5	22429.5	
22108	22338.0	22430.0	
22109	22338.5	22430.5	
22110	22339.0	22431.0	
22111	22339.5	22431.5	
22112	22340.0	22432.0	
22113	22340.5	22432.5	
22114	22341.0	22433.0	
22115	22341.5	22433.5	
22116	22342.0	22434.0	
22117	22342.5	22434.5	
22118	22343.0	22435.0	
22119	22343.5	22435.5	
22120	22344.0	22436.0	
22121	22344.5	22436.5	
22122	22345.0	22437.0	
22123	22345.5	22437.5	
22124	22346.0	22438.0	
22125	22346.5	22438.5	
22126	22347.0	22439.0	
22127	22347.5	22439.5	
22128	22348.0	22440.0	
22129	22348.5	22440.5	
22130	22349.0	22441.0	
22131	22349.5	22441.5	
22132	22350.0	22442.0	
22133	22350.5	22442.5	
22134	22351.0	22443.0	
22135	22351.5	22443.5	
22136	22352.0	22352.0	Simplex
22137	22352.5	22352.5	Simplex
22138	22353.0	22353.0	Simplex
22139	22353.5	22353.5	Simplex
22140	22354.0	22354.0	Simplex
22141	22354.5	22354.5	Simplex
22142	22355.0	22355.0	Simplex
22143	22355.5	22355.5	Simplex
22144	22356.0	22356.0	Simplex

CH No.	Tx (kHz)	Rx (kHz)	Remarks
22145	22356.5	22356.5	Simplex
22146	22357.0	22357.0	Simplex
22147	22357.5	22357.5	Simplex
22148	22358.0	22358.0	Simplex
22149	22358.5	22358.5	Simplex
22150	22359.0	22359.0	Simplex
22151	22359.5	22359.5	Simplex
22152	22360.0	22360.0	Simplex
22153	22360.5	22360.5	Simplex
22154	22361.0	22361.0	Simplex
22155	22361.5	22361.5	Simplex
22156	22362.0	22362.0	Simplex
22157	22362.5	22362.5	Simplex
22158	22363.0	22363.0	Simplex
22159	22363.5	22363.5	Simplex
22160	22364.0	22364.0	Simplex
22161	22364.5	22364.5	Simplex
22162	22365.0	22365.0	Simplex
22163	22365.5	22365.5	Simplex
22164	22366.0	22366.0	Simplex
22165	22366.5	22366.5	Simplex
22166	22367.0	22367.0	Simplex
22167	22367.5	22367.5	Simplex
22168	22368.0	22368.0	Simplex
22169	22368.5	22368.5	Simplex
22170	22369.0	22369.0	Simplex
22171	22369.5	22369.5	Simplex
22172	22370.0	22370.0	Simplex
22173	22370.5	22370.5	Simplex
22174	22371.0	22371.0	Simplex
22175	22371.5	22371.5	Simplex
22176	22372.0	22372.0	Simplex
22177	22372.5	22372.5	Simplex
22178	22373.0	22373.0	Simplex
22179	22373.5	22373.5	Simplex
22180	22374.0	22374.0	Simplex
2501	25173.0	26101.0	
2502	25173.5	26101.5	
2503	25174.0	26102.0	
2504	25174.5	26102.5	
2505	25175.0	26103.0	
2506	25175.5	26103.5	
2507	25176.0	26104.0	

CH No.	Tx (kHz)	Rx (kHz)	Remarks
2508	25176.5	26104.5	
2509	25177.0	26105.0	
2510	25177.5	26105.5	
2511	25178.0	26106.0	
2512	25178.5	26106.5	
2513	25179.0	26107.0	
2514	25179.5	26107.5	
2515	25180.0	26108.0	
2516	25180.5	26108.5	
2517	25181.0	26109.0	
2518	25181.5	26109.5	
2519	25182.0	26110.0	
2520	25182.5	26110.5	
2521	25183.0	26111.0	
2522	25183.5	26111.5	
2523	25184.0	26112.0	
2524	25184.5	26112.5	
2525	25185.0	26113.0	
2526	25185.5	26113.5	
2527	25186.0	26114.0	
2528	25186.5	26114.5	
2529	25187.0	26115.0	
2530	25187.5	26115.5	
2531	25188.0	26116.0	
2532	25188.5	26116.5	
2533	25189.0	26117.0	
2534	25189.5	26117.5	
2535	25190.0	26118.0	
2536	25190.5	26118.5	
2537	25191.0	26119.0	
2538	25191.5	26119.5	
2539	25192.0	26120.0	
2540	25192.5	26120.5	
2541	25193.0	25193.0	Simplex
2542	25193.5	25193.5	Simplex
2543	25194.0	25194.0	Simplex
2544	25194.5	25194.5	Simplex
2545	25195.0	25195.0	Simplex
2546	25195.5	25195.5	Simplex
2547	25196.0	25196.0	Simplex
2548	25196.5	25196.5	Simplex
2549	25197.0	25197.0	Simplex
2550	25197.5	25197.5	Simplex
2551	25198.0	25198.0	Simplex

Appendix

CH No.	Tx (kHz)	Rx (kHz)	Remarks
2552	25198.5	25198.5	Simplex
2553	25199.0	25199.0	Simplex
2554	25199.5	25199.5	Simplex
2555	25200.0	25200.0	Simplex
2556	25200.5	25200.5	Simplex
2557	25201.0	25201.0	Simplex
2558	25201.5	25201.5	Simplex
2559	25202.0	25202.0	Simplex
2560	25202.5	25202.5	Simplex
2561	25203.0	25203.0	Simplex

CH No.	Tx (kHz)	Rx (kHz)	Remarks
2562	25203.5	25203.5	Simplex
2563	25204.0	25204.0	Simplex
2564	25204.5	25204.5	Simplex
2565	25205.0	25205.0	Simplex
2566	25205.5	25205.5	Simplex
2567	25206.0	25206.0	Simplex
2568	25206.5	25206.5	Simplex
2569	25207.0	25207.0	Simplex
2570	25207.5	25207.5	Simplex
2571	25208.0	25208.0	Simplex

*1) Used for distress and safety purposes.

11.5 Guide to MF/HF operation

Be aware of the following points when using the MF/HF radio equipment.

- Frequencies available for communication are always changing.
- Not all frequency bandwidths can always be used for communication.
- After sending the DSC test call to a coast station, you will not always receive the acknowledgement.

1. About the MF/HF radio equipment

Although for ship MF/HF radio equipment the 1.6 MHz to 27.5 MHz frequencies are normally available, select an appropriate frequency from the frequencies assigned to your ship for communication. As noted below, the use of the appropriate frequency depends upon the radio wave propagation characteristics of the ionosphere. **Therefore, not all frequency bands are available for communication even if the equipment is functioning properly.**

2. Special characteristics of MF/HF radio wave propagation

As shown in the figure to the right, the major MF/HF radio waves used for communications are terrestrial waves (path 1) and waves reflected from the ionosphere (paths 2 and 3). You can communicate using waves reflected from the ionosphere and the earth because the effective communication range of terrestrial waves is limited⁶.

The available range of frequencies for communication depends upon the radio wave propagation characteristics of the ionosphere. They will also change dramatically depending on the position and distance from the station, the season, the time, and the sunspot number (approx. 0 to 250) which changes every 11 years⁷.

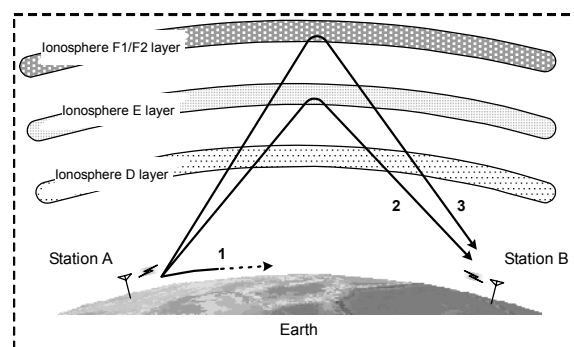

The available range of frequencies for communication depends upon the radio wave propagation characteristics of the ionosphere. They will also change dramatically depending on the position and distance from the station, the season, the time, and the sunspot number (approx. 0 to 250) which changes every 11 years⁷.

3. Selecting communication frequencies

MF/HF band communication frequencies cannot be predetermined. However, you can select frequencies referring to previous communications logs, the frequency transition table in this chapter under "Selecting communication frequencies in the MF/HF band (reference)", and the radio wave propagation image.

4. About DSC testing

DSC operation is prescribed as an international standard⁸ of the ITU and coast stations that receive DSC test calls should acknowledge the calls. Responses may be sent manually instead of automatically depending on the equipment at the coast station. **It may take longer than expected to receive the acknowledgement even if your equipment is functioning properly and you have selected the proper frequency.**

⁶ You may experience skip zones where both terrestrial waves and waves reflected from the ionosphere are unavailable at the end of the effective communication range of terrestrial waves.

⁷ Radio wave propagation is affected by phasing, the Dellinger phenomenon, magnetic storms, and atmospheric. Interference tends to be greater at night when radio waves can travel greater distances.

⁸ ITU-R Recommendation M. 541

Selecting communication frequencies in the MF/HF band (reference)

When communicating with the MF/HF radio equipment, select frequencies referring to the frequency transition table and the radio wave propagation images (excluding the polar latitudes) shown below⁹.

Example: When communicating with a station approximately 5000 km away at around 12 pm in the winter with a sunspot number of 100, select frequencies in the 18, 22, or 25 MHz bands for the best results.

➤ Frequency transition table

Transmissions conditions			Guideline for selecting frequency (for a sunspot count of 100)								
Distance	Season & time		2M	4M	6M	8M	12M	16M	18M	22M	25M
Long distances (e.g. 5000 km)	Winter	Day	[Shaded area from 12M to 25M]								
		Night	[Shaded area from 4M to 12M]								
	Summer	Day	[Shaded area from 8M to 18M]								
		Night	[Shaded area from 2M to 12M]								
Short distances (e.g. 1000 km)	Winter	Day	[Shaded area from 6M to 12M]								
		Night	[Shaded area from 2M to 6M]								
	Summer	Day	[Shaded area from 4M to 8M]								
		Night	[Shaded area from 2M to 4M]								

➤ Radio wave propagation images

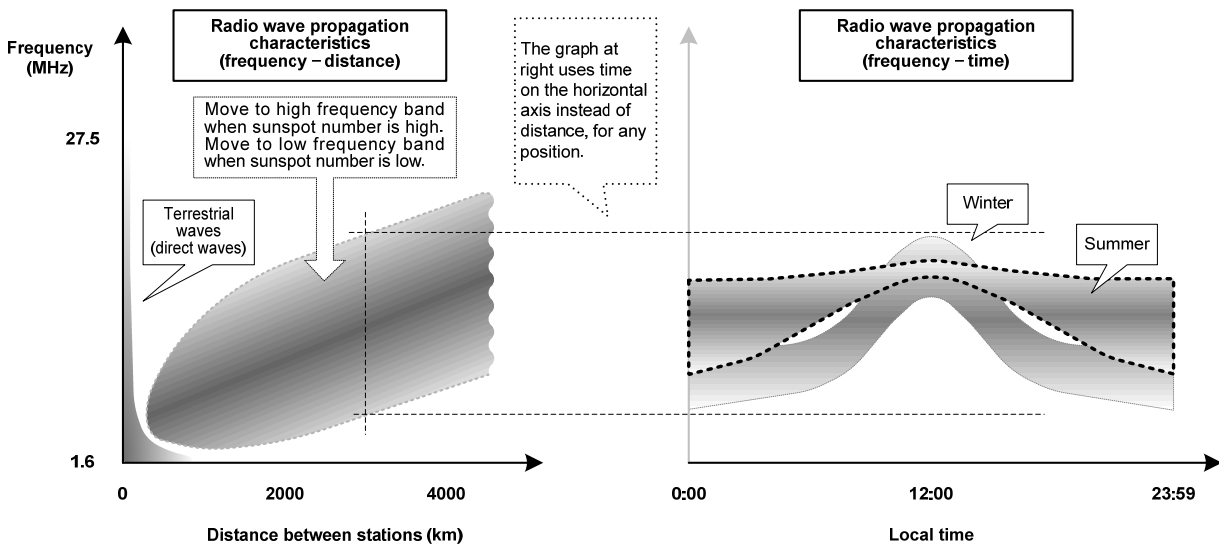

⁹ These are based on the prediction of HF radio wave propagations. Communication is not guaranteed.

电子信息产品有害物资申明

日本无线株式会社

Declaration on toxic & hazardous substances or elements of Electronic Information Products Japan Radio Company Limited

有毒有害物质或元素的名称及含量

(Names & Content of toxic and hazardous substances or elements)

形式名(Type): JSS-2150

名称(Name): MF/HF Radio equipment

部件名称 (Part name)	有毒有害物质或元素 (Toxic and Hazardous Substances and Elements)					
	铅 (Pb)	汞 (Hg)	镉 (Cd)	六价铬 (Cr ⁶⁺)	多溴联苯 (PBB)	多溴二苯醚 (PBDE)
天线 (Antenna)	×	○	×	×	×	×
船内装置 (Inboard Unit)	×	○	×	×	×	×
外部设备(Peripherals) ·选择(Options) ·打印机(Printer) ·电线类(Cables) ·手册(Documentts)	×	○	×	×	×	×
<p>○: 表示该有毒有害物质在该部件所有均质材料中的含量均在SJ/T11306-2006 标准规定的限量要求以下。 (Indicates that this toxic, or hazardous substance contained in all of the homogeneous materials for this part is below the requirement in SJ/T11363-2006.)</p> <p>×: 表示该有毒有害物质至少在该部件的某一均质材料中的含量超出SJ/T11363-2006 标准规定的限量要求。 (Indicates that this toxic or hazardous substance contained in at least one of the homogeneous materials used for this part is above the limit requirement in SJ/T 11363-2006.)</p>						

JRC Code No. : 7ZPJD0492

Marking with market circulation mark

According to the requirements of clause 20 of Technical Regulations about safety of Maritime transport objects, approved by Resolution of the Russian Federation Government #620 dated August 12, 2010 and requirements Technical Regulation of the Russian Federation Government #623 dated August 12, 2010 navigation & radiotelephone equipment should be marked by company – manufacturer with market-circulation mark the way it is determined by Legislation of the Russia federation on technical regulation.

According to the article 27 PZ No184 –FZ of Federal Law about Technical Regulation dated December 12, 2002 and Resolution of the Russian Federation Government dated 19.11.03 No0696 navigation equipment has an appropriate marking. The marking can be performed by one of four variants, depending on surface colour of equipment.



The images should be grey scale and should contrast against the surface colour (ref. to the Resolution of the Russian Federation Government No696 <<About market circulation mark>> dated November 19, 2003).

The marking of Radio and navigational equipment should be done by the manufacturer (supplier) according to the clause 2 of the article 27 of the Federal Law No.184 –FZ << About technical Regulation>> and should be applied right to device surface.

アスベストは使用しておりません
Not use the asbestos

CODE No.7ZPJD0569

For further information, contact:

JRC *Japan Radio Co., Ltd.*

Since 1915

URL <http://www.jrc.co.jp>

Marine Service Department

Telephone : +81-3-3492-1305

Facsimile : +81-3-3779-1420

e-mail : tmisc@jrc.co.jp

SEATTLE Branch

Telephone : +1-206-654-5644

Facsimile : +1-206-654-7030

e-mail : marineservice@jrcamerica.com

ALPHATRON

Alphatron Marine BV

URL <http://www.alphatronmarine.com>

Rotterdam (Head office)

Alphatron Marine B.V.

Telephone : +31 (0)10- 453 4000

Facsimile : +31 (0)10- 452 9214

e-mail : service@alphatronmarine.com

Singapore Branch

Alphatron Marine Systems Pte Ltd

Telephone : +65 6863 0335

Facsimile : +65 6863 3305

e-mail : service@alphatronmarinesystems.com

01ETM

ISO 9001, ISO 14001 Certified

©DEC. 2015 Edition 1 JRC

Printed in Japan