

**JHS-800S**

---

**MARINE VHF RADIOTELEPHONE**

**INSTRUCTION  
MANUAL**

**JRC** *Japan Radio Co., Ltd.*



## Safety Precautions

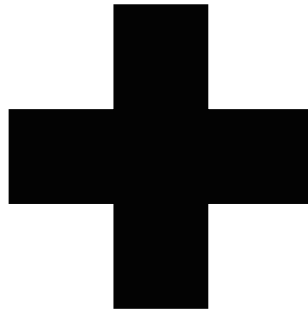

### CAUTIONS AGAINST HIGH VOLTAGE

Radio and radar devices are operated by high voltages of anywhere from a few hundred volts up to many hundreds of thousands of volts.

Observe the following precautions to prevent the risk of electric shock.

Avoid contact with the internal parts of these devices.

Only specialized service people should do any maintenance, inspections, or adjustments inside the devices.

Falling after receiving an electric shock may lead to extensive secondary injuries, so be sure you have a safe place to stand when working.

In the event that someone receives an electric shock, immediately implement emergency procedures, such as cardiopulmonary resuscitation.

If you must reach into a device, as in the case of an emergency, you must switch off the devices and ground a terminal in order to discharge the capacitors. After making certain that all the electricity is discharged, only then can you insert your hand into the device. Wearing dry cotton work gloves is another way to reduce risks. One more necessary precaution is to not use both hands at the same time.

Although there is no danger with normal use, it is very dangerous if contact is made accidentally with the internal parts of these devices. There is a very high risk of death by high voltages of tens of thousands of volts. In some cases, you could be fatally electrocuted by voltages of several hundred volts.

### Precautions for rescuing victims from electrocution

If you find an electrocution victim, you must first switch off the machinery that caused the electrocution and ground all circuits.

If you are unable to immediately cut off the circuit, do not directly touch the victim. Quickly use a non-conductive material, such as a dry board or cloth, to move the victim away from the device.

If someone receives an electric shock, immediately implement emergency procedures, such as cardiopulmonary resuscitation.

When a person is electrocuted, the current passes through their heart and may cause ventricular fibrillation or cardiac arrest. Also, if the shock is mild, the victim's breathing may be restored by doing artificial respiration. An electrocution victim becomes very pale, their pulse can be very weak or even stop, and they may lose consciousness and become stiff.

## Emergency First Aid Procedure

### Flow of Cardiopulmonary Resuscitation (CPR) using AED

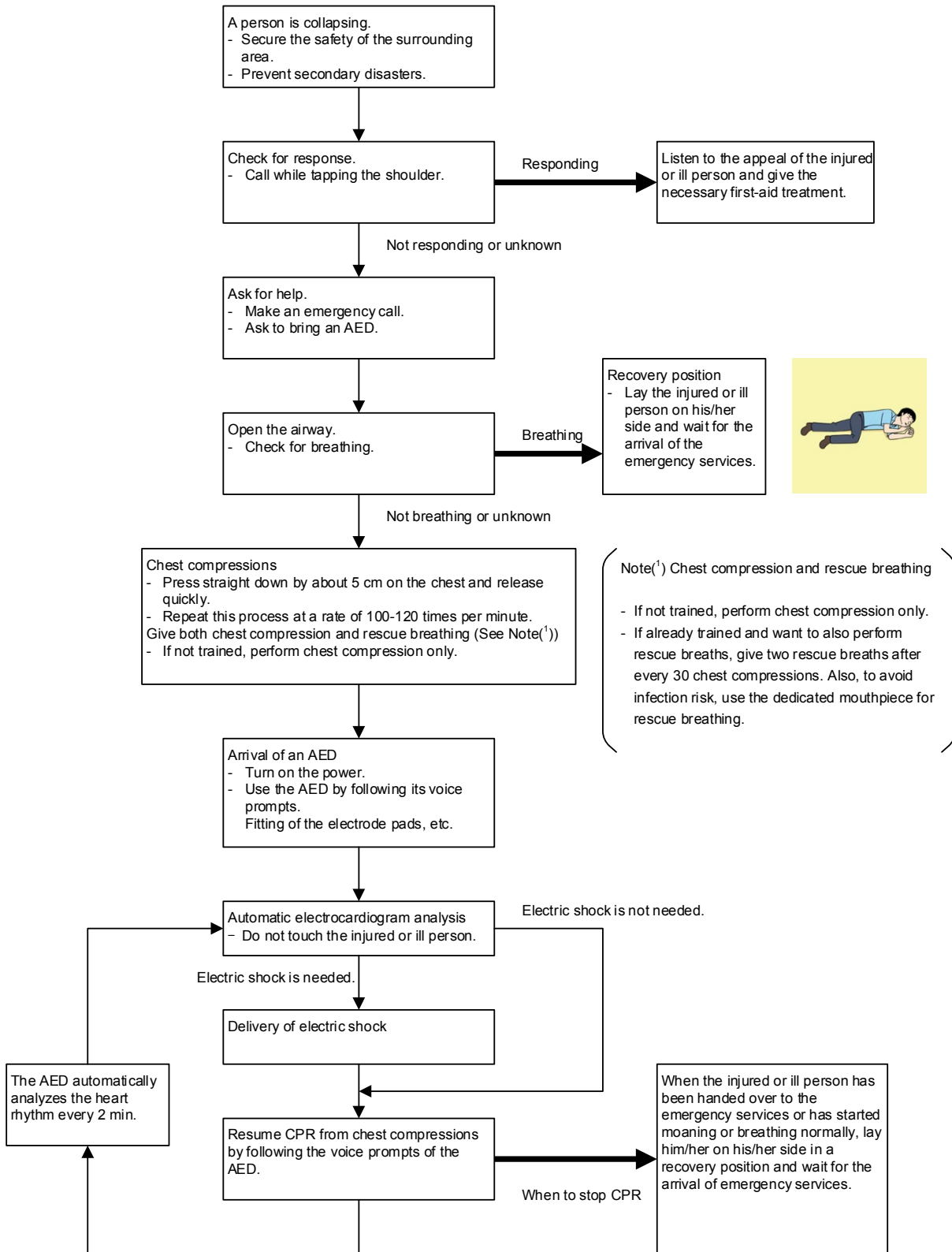

## Procedure for Cardiopulmonary Resuscitation (CPR) using AED

1. Check the scene for safety to prevent secondary disasters
  - a) Do not touch the injured or ill person in panic when an accident has occurred. (Doing so may cause electric shock to the first-aiders.)
  - b) Do not panic and be sure to turn off the power. Then, gently move the injured or ill person to a safe place away from the electrical circuit.
2. Check for responsiveness
  - a) Tap the shoulder of the injured or ill and shout in the ear saying, "Are you OK?"
  - b) If the person opens his/her eyes or there is some response or gesture, determine it as "responding." But, if there is no response or gesture, determine it as "not responding."
3. If responding
  - a) Give first-aid treatment.
4. If not responding
  - a) Ask for help loudly. Ask somebody to make an emergency call and bring an AED.
    - Somebody has collapsed. Please help.
    - Please call an ambulance.
    - Please bring an AED.
    - If there is nobody to help, call an ambulance yourself.
5. Check for breathing
  - a) Look to see if the chest and abdomen are rising and falling.

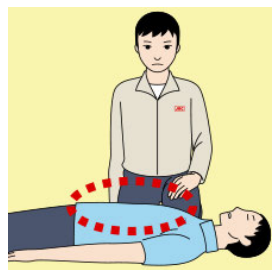

- b) If the injured or ill person is breathing, place him/her in the recovery position and wait for the arrival of the emergency services.

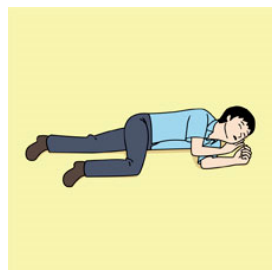

## 6. Cardiopulmonary resuscitation (CPR) (Combination of chest compressions and rescue breaths)

### a) Chest compressions

#### 1) Position of chest compressions

- Position the heel of one hand in the center of the chest, approximately between the nipples, and place your other hand on top of the one that is in position.

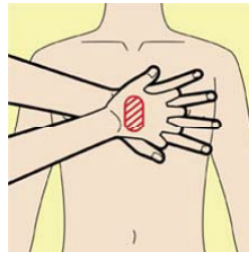
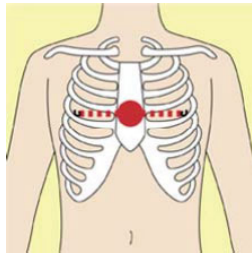

#### 2) Perform chest compressions

- Perform uninterrupted chest compressions of 30 at the rate of about 100-120 times per minute. While locking your elbows positioning yourself vertically above your hands.
- With each compression, depress the chest wall to a depth of approximately 5 cm.

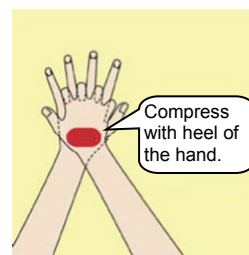

### b) Combination of 30 chest compressions and 2 rescue breaths

- 1) If not trained, perform the chest compressions only.
- 2) If already trained and want to also perform rescue breaths, give two rescue breaths after every 30 chest compressions.
- 3) To avoid infection risk, use the dedicated mouthpiece for rescue breathing.
- 4) Continuously perform the combination of 30 chest compressions and 2 rescue breaths without interruption.
- 5) If there are two or more first-aiders, alternate with each other approximately every two minutes (five cycles of compressions and ventilations at a ratio of 30:2) without interruption.

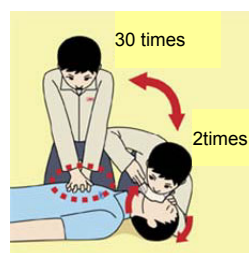

7. When to stop cardiopulmonary resuscitation (CPR)
- When the injured or ill person has been handed over to the emergency services
  - When the injured or ill person has started moaning or breathing normally, lay him/her on his/her side in a recovery position and wait for the arrival of emergency services.



8. Arrival and preparation of an AED

- Place the AED at an easy-to-use position. If there are multiple first-aiders, continue CPR until the AED becomes ready.
- Turn on the power to the AED unit. Depending on the model of the AED, you may have to push the power on button, or the AED automatically turns on when you open the cover.
- Follow the voice prompts of the AED.

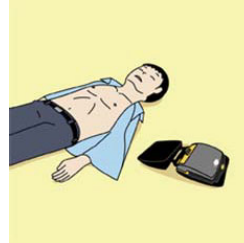

9. Attach the electrode pads to the injured or ill person's bare chest

- Remove all clothing from the chest, abdomen, and arms.
- Open the package of electrode pads, peel the pads off and securely place them on the chest of the injured or ill person, with the adhesive side facing the chest. If the pads are not securely attached to the chest, the AED may not function. Paste the pads exactly at the positions indicated on the pads, if the chest is wet with water, wipe dry with a dry towel and the like, and then paste the pads. If there is a pacemaker or implantable cardioverter defibrillator (ICD), paste the pads at least 3cm away from them. If a medical patch or plaster is present, peel it off and then paste the pads. If the injured or ill person's chest hair is thick, paste the pads on the chest hair once, peel them off to remove the chest hair, and then paste new pads.
- Some AED models require to connect a connector by following voice prompts.
- The electrode pads for small children should not be used for children over the age of 8 and for adults.

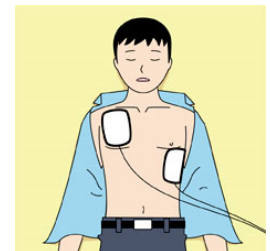
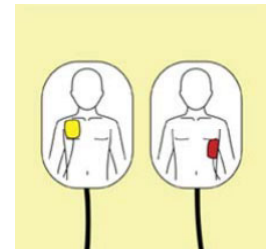

10. Electrocardiogram analysis

- The AED automatically analyzes electrocardiograms. Follow the voice prompts of the AED and ensure that nobody is touching the injured or ill person while you are operating the AED.
- On some AED models, you may need to push a button to analyze the heart rhythm.



### 11. Electric shock (defibrillation)

- a) If the AED determines that electric shock is needed, the voice prompt saying, "Shock is needed" is issued and charging starts automatically.
- b) When charging is completed, the voice prompt saying, "Press the shock button" is issued and the shock button flashes.
- c) The first-aider must get away from the injured or ill person, make sure that no one is touching him/her, and then press the shock button.
- d) When electric shock is delivered, the body of the injured or ill person may jerk.

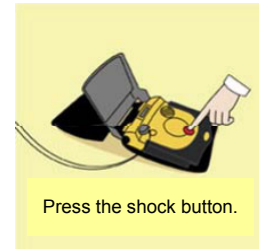

### 12. Resume cardiopulmonary resuscitation (CPR)

- a) Resume CPR by following the voice prompts of the AED.
  - Perform uninterrupted chest compressions at the rate of about 100-120 times per minute.
  - With each compression, depress the chest wall to a depth of approximately 5 cm.



### 13. Automatic electrocardiogram analysis

- a) When 2 minutes have elapsed since you resumed cardiopulmonary resuscitation (CPR), the AED automatically analyzes the electrocardiogram.
- b) If you suspended CPR by following voice prompts and AED voice prompt informs you that shock is needed, give electric shock again by following the voice prompts.  
If AED voice prompt informs you that no shock is needed, immediately resume CPR.

### 14. When to stop CPR (Keep the electrode pads on)

- a) When the injured or ill person has been handed over to the emergency services.
- b) When the injured or ill person has started moaning or breathing normally, lay him/her on his/her side in a recovery position and wait for the arrival of emergency services.

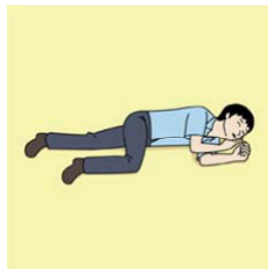



## Preface

Thank you for purchasing JRC's JHS-800S Marine VHF Radiotelephone. This radiotelephone can be used as a Global Maritime Distress and Safety System (GMDSS) radio device, compliant with international regulations, that provides emergency communications and standard communications capabilities for small and large ships.

- Please read this instruction manual thoroughly before using the equipment.
- Please keep this manual available for future reference. And please refer to this if any difficulties are encountered when using the equipment.

### FCC Warning

Changes or modifications not expressly approved by JRC, could void your authority to operate this radiotelephone.

### Radio Frequency Interference Statement

This radiotelephone has been tested and found to comply with the limits for a Class A digital device, pursuant to part 15 of the FCC Rules. These limits are designed to provide reasonable protection against harmful interference when the equipment is operated in a commercial environment. This radiotelephone generates, uses, and can radiate radio frequency energy and, if not installed and used in accordance with the instruction manual, may cause harmful interference to radio communications. Operation of this radiotelephone in a residential area is likely to cause harmful interference in which case the user will be required to correct the interference at his own expense.

This device complies with part 15 of the FCC rules. Operation is subject to the following two conditions:  
(1) This device may not cause harmful interference, and  
(2) This device must accept any interference received, including interference that may cause undesired operation.

This device complies with Industry Canada license-exempt RSS standard(s). Operation is subject to the following two conditions:  
(1) This device may not cause interference, and  
(2) This device must accept any interference, including interference that may cause undesired operation of the device.

Le présent appareil est conforme aux CNR d'Industrie Canada applicables aux appareils radio exempts de licence. L'exploitation est autorisée aux deux conditions suivantes :  
(1) L'appareil ne doit pas produire de brouillage, et  
(2) L'utilisateur de l'appareil doit accepter tout brouillage radioélectrique subi, même si le brouillage est susceptible d'en compromettre le fonctionnement.



RF exposure compliance (MPE\* compliance by FCC)

The antenna used for this transmitter must be installed to provide a separation distance of at least 0.9 meters (3 feet) from all persons and must not be co-located or operating in conjunction with any other antenna or transmitter. Users and installers must be provided with antenna installation instructions and transmitting operating conditions for satisfying RF exposure compliance.

\* Maximum Permissible Exposure (MPE): The rms and peak electric and magnetic field strength, their squares, or the plane-wave equivalent power densities associated with these fields to which a person may be exposed without harmful effect and with an acceptable safety factor.

Conformité à l'exposition aux RF (conformité MPE \* par FCC)

L'antenne utilisée pour cet émetteur doit être installée de manière à fournir une distance de séparation d'au moins 0,9 mètre (3 pieds) de toutes les personnes et ne doit pas être colocalisée ou fonctionner en conjonction avec une autre antenne ou émetteur. Les utilisateurs et les installateurs doivent recevoir des instructions d'installation de l'antenne et des conditions de fonctionnement de transmission pour satisfaire la conformité d'exposition RF.

\* Exposition maximale autorisée (MPE): La valeur efficace et l'intensité maximale des champs électriques et magnétiques, leurs carrés ou les densités de puissance équivalentes en ondes planes associées à ces champs auxquels une personne peut être exposée sans effet nocif et avec un facteur de sécurité acceptable.

## Before Operation

### Concerning the symbols

This manual uses the following symbols to explain correct operation and to prevent injury or damage to property.

The symbols and descriptions are as follows. Understand them before proceeding with this manual.



### WARNING

Indicates a warning that, if ignored, may result in serious injury or even death.



### CAUTION

Indicates a caution that, if ignored, may result in injury or damage to property.

### Examples of symbols



The  $\triangle$  symbol indicates caution (including DANGER and WARNING). The illustration inside the  $\triangle$  symbol specifies the content of the caution more accurately. (This example warns of possible electrical shock.)



The  $\otimes$  symbol indicates that performing an action is prohibited. The illustration inside the  $\otimes$  symbol specifies the contents of the prohibited operation. (In this example disassembly is prohibited.)



The  $\bullet$  symbol indicates operations that must be performed. The illustration inside the  $\bullet$  symbol specifies obligatory instructions. (In this example unplugging is the obligatory instruction.)

### About Warning Labels

There is warning labels on the main unit (JHS-800S) and the power supply unit (NBD-980). Do not remove, damage, or alter the warning labels.

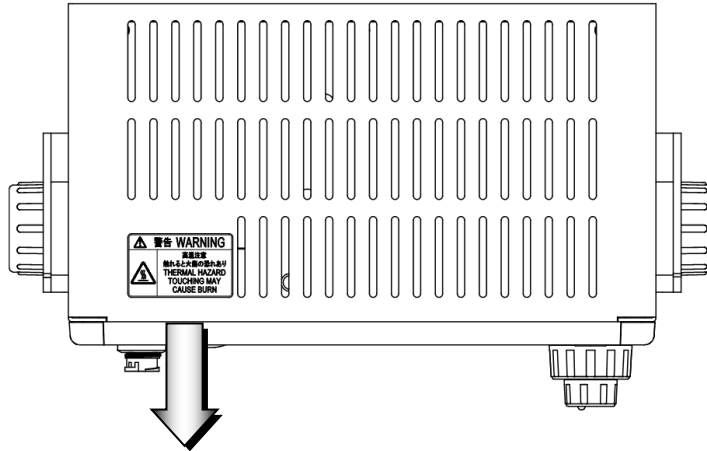

JHS-800S Marine VHF Radiotelephone

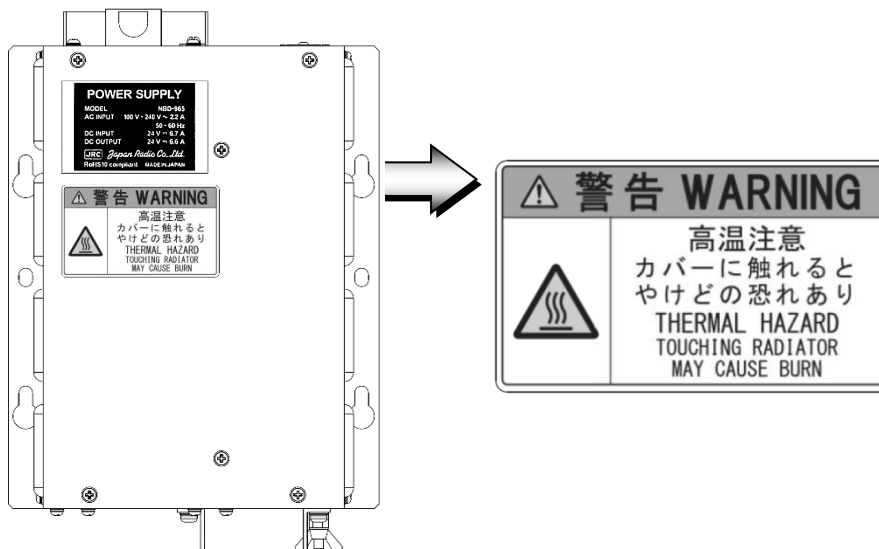

NBD-965 AC/DC Power supply

## Handling precaution

### **WARNING**



Do not open the equipment to inspect or repair it. Inspection or repairs by anyone other than a specialized technician may result in fire, electrical shock, or malfunction.



If internal inspection or repair is necessary, contact our service center or agents.



Do not disassemble or customize this unit. Doing so may cause fire, electrical shock, or malfunction.



Do not get this equipment wet or spill any liquids on or near this equipment. Doing so may cause electrical shock or equipment malfunction.



Do not touch any of the areas with warning labels. Doing so may cause burn.



Do not use a voltage other than specified. Doing so may cause fire, electrical shock, or malfunction.



Do not remove protective covers on the high voltage terminals. Doing so may cause electrical shock.



Do not insert anything flammable into the equipment. Doing so may cause fire, electrical shock, or malfunction.



If a distress alert is received, make sure to inform the ship's captain or officer in charge. Doing so may save the lives of the crews and passengers on the ship in distress.



If any problem is observed in this unit on usual operation or inspection, contact JRC or our agent. In addition to usual communication, this unit is also used for the distress communication.



Before replacing fuses of the AC/DC POWER SUPPLY (NBD-965), always turn off the AC/DC power switch and power source output to this unit.



Always use the specified fuse when replacing a fuse. Using a different fuse may result in fire or malfunction.



Do not use the wireless speaker microphone in the hazardous area for the presence of any explosive or combustible gas. Doing so may cause an explosion of fire.



If using a web browser on the personal computer to register waypoints for the block channel function, do it only while the radio communication is not needed. The main unit shows BROWSING MODE and is not available after starting the registration.



# CAUTION



Do not use this equipment for anything other than specified.  
Doing so may cause failure or malfunction.



Do not install this equipment in a place near water or in one with excessive humidity, steam, dust or soot. Doing so may cause fire, electric shock, or malfunction.



Do not test the distress alert as doing so will inconvenience local shipping and Rescue Centers.



Do NOT turn off the power of the equipment when at sea because the SOLAS Convention requires keeping CH16 watch at all times.



Always listen to the CH16 except when talking on a specific channel.



To operate DSC and ATIS functions of this equipment, ID numbers must be registered respectively. If not been registered, contact our agent or service center.



Leave installation of this equipment to our service center or agents. Special knowledge on selecting the place where the antenna is to be mounted and setting the ID number (MMSI) assigned to the ship is required besides mounting operation.



When sending a distress alert, follow the instructions of the ship's captain or officer in charge.



If a false distress alert is transmitted accidentally, use the [CANCEL] button to cancel transmission of the distress alert. Then report the false distress alert to a nearby RCC (Rescue Coordination Center). In Japan, inform the nearest Japan Coast Guard. Follow the on-screen instructions to report the following information.

Ship's name, type, nationality, and ID number, the date/time, location and reason why the false distress alert was transmitted.

Also the unit model name and manufacture number/date, if possible.



To turn off an alert sound or clear a display such as a received DSC message, do NOT press the **DISTRESS** button but use the [CLOSE] and [STOP] buttons following the description on the screen.



# CAUTION



When sending a drobose call, do NOT press the **DISTRESS** button but use the [CALL] button displayed on the screen.



A distress acknowledgement or a distress relay call can be transmitted by using the buttons on the receiving distress event screen. But when sending such a kind of call, always follow the instructions of the ship's captain or officer in charge.



Close the water-resistant cap of the waterproof type handset box after use and keep the handsets indoors.  
Rain and sea breeze could cause connector malfunction.



The thermal head of the printer (option) may be very hot after printing. Do not touch it. Perform paper replacement and head cleaning only after waiting for the head to completely cool.



Do not put your finger etc. because there is a cutter blade at the paper discharge port when using printer (option). Also, do not touch the blade of the cutter when opening the paper cover.



The printing paper used in this printer (option) is a heat sensitive paper. Take the following precautions when using this paper.

- Store the paper away from heat, humidity, or heat sources.
- Do not rub the paper with any hard objects.
- Do not place the paper near organic solvents.
- Do not allow the paper to come in contact with polyvinyl chloride film, erasers, or adhesive tape for long periods of time.
- Keep away the paper from freshly copied diazo type or wet process copy paper.



Always set the expanded MMSI in the bridge of the vessel to zero (0). If setting to another value other than zero, DSC calls may not be received.



Do not use a sharp object for touch panel operation.  
Otherwise, the screen may be damaged.



Keep away at least 0.6 meters from the VHF antenna to avoid radio frequency radiation hazard.

# DISTRESS ALERTS

## Sending a Distress Alert



### CAUTION



When sending a distress alert, follow the instructions of the ship's captain or officer in charge.

1. Open the protective cover on the **DISTRESS** button for the JHS-800S Marine VHF radiotelephone or NCM-980 Controller.



2. Press and hold the **DISTRESS** button for at least 3 seconds until the countdown is complete.

When the countdown is complete, the screen below on the right is displayed and after confirmed that the channel is free or after 1 second whichever occurs first, the distress alert is transmitted.

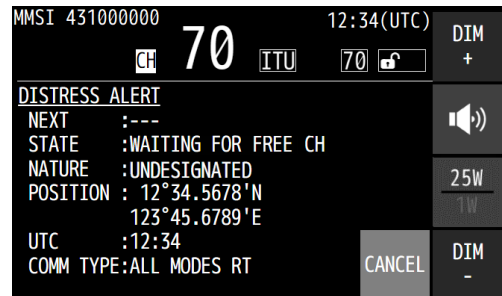

3. After sending the distress alert, wait for an acknowledgement.

The radiotelephone can be used to communicate even while waiting for an acknowledgement. When an acknowledgement is received, touch the [STOP] button to silence the alert sound on the below right screen, and communicate with the station. Unless an acknowledgement is received or the distress alert is cancelled manually, the equipment repeats the distress alert every 3 minutes 30 seconds to 4 minutes 30 seconds.

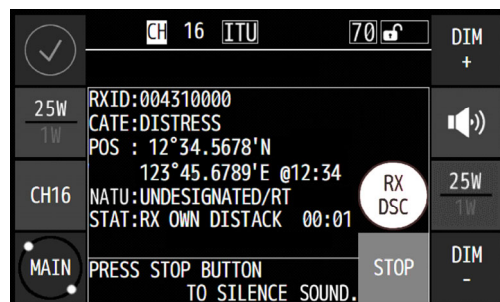
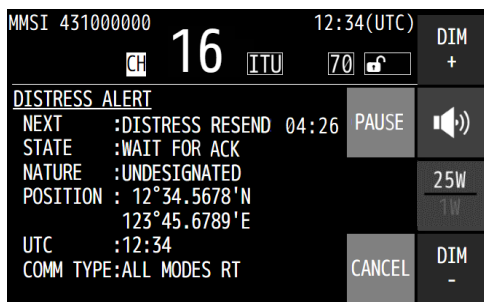

4. After receiving acknowledgement, lift the handset and request rescue using CH16 of the radiotelephone.

First, the responding station calls by radiotelephone. Communicate the following information to that station.

Say "MAYDAY", "This is (name of your ship)", Tell the ship's Maritime Mobile Service Identity number, call sign, ship's position, nature of distress, and rescue requests.



Note

If time permits, enter the nature of the distress as follows, just before sending the distress alert. (For more details, see 4.4.5.2.)

- 1) On the status display, touch the [DIST-E] button.
- 2) On the screen at right, touch the [EDIT]→ [NATURE] buttons and then select the nature of distress.
- 3) Touch the [✓] button.  
The nature of distress is set. If the position and time are not displayed automatically, select the [EDIT]→[POS UTC] buttons and input them manually.
- 4) With this DIST-E menu open, press and hold the **DISTRESS** button for 3 seconds to send the distress alert..  
The rest of the procedure is as same as described above.

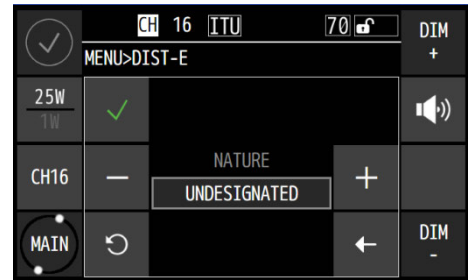
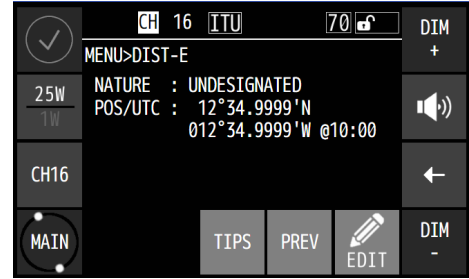

## Terminating a Distress Alert

### CAUTION



If a false distress alert is transmitted accidentally, use the [CANCEL] button to cancel transmission of the distress alert. Then report the false distress alert to a nearby RCC (Rescue Coordination Center). In Japan, inform the nearest Japan Coast Guard. Follow the on-screen instructions to report the following information.

Ship's name, type, nationality, and ID number, the date/time, location and reason why the false distress alert was transmitted.

Also the unit model name and manufacture number/date, if possible.

#### Touch the [CANCEL] button.

The popup shown below is displayed. Touching the [YES] button cancels transmission of the distress alert. After that, follow the on-screen instructions.

Note) For more details, see the description in the 4.4.5.1 Quick distress alerts.



# Receiving a Distress Alert

## WARNING



If a distress alert is received, make sure to inform the ship's captain or officer in charge. Doing so may save the lives of the crews and passengers on the ship in distress.

1. When a distress alert is received, the BAM alert information is immediately appeared. Then touch the **CLOSE** button to close it and display the DSC detail information such as the ID number of the ship in distress and the stage of the distress event.

If the equipment is not used, i.e. there is no active procedure at that time, the CH16 is set and the Receive mark starts blinking, and the alert sound gradually grows louder.

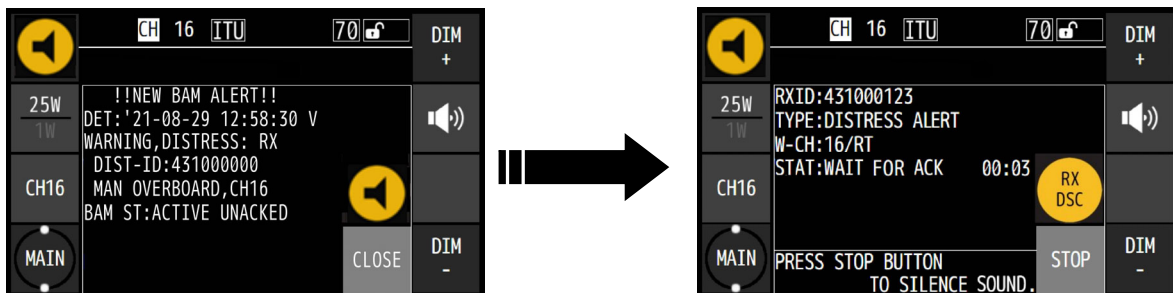

2. Touch the **[STOP]** button to stop the alert sound.

Keep watch on CH16 for at least 5 minutes, and notify the coast station as appropriate.

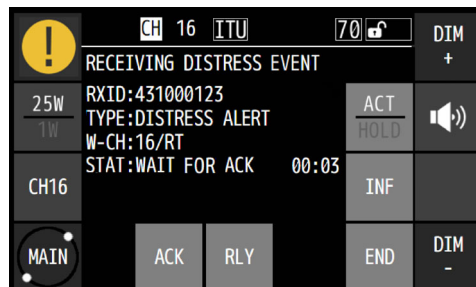

**Note** Even If there is no active procedure, when the AUTO CH CHG is OFF in the DSC operation menu, the channel is not automatically changed to CH16. In this case, after pressing the **[STOP]** button to stop the alert sound, select the **[ACCEPT]** on the popup screen to set the CH16 and skip to step 3.

3. Touch the **[ACK]** button to respond from your own ship with the results of coordinating with the coast station and monitoring CH16.

After sending it, commence distress traffic via radiotelephony on CH16 as follows.

- Say "MAYDAY",
- Repeat the identity (MMSI) of the ship in distress 3 times,
- Say "This is",
- Repeat the identity (MMSI) of your ship 3 times,
- Say "RECEIVED MAYDAY".

## Equipment exterior

- JHS-800S Marine VHF Radiotelephone/ NQW-980 Handset



- NCM-980 Controller/ NQW-980 Handset



- NQE-1845B Handset Connector Box  
Waterproofed flush mount type  
(for wing console)



- NQE-1846 Handset Connector Box  
Waterproofed wing installation type

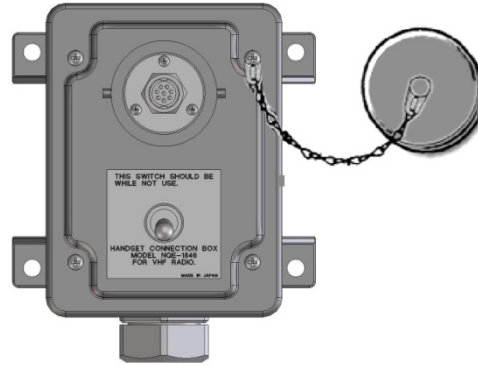

- NQE-1847B Handset Connector Box  
Indoor flush mount type



- NBD-965 AC/DC Power Unit



- NCH-3210 Distress Message Controller

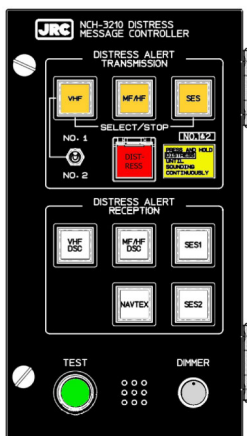

- RP-D10 Printer



- NVS-423R/823R External Speaker

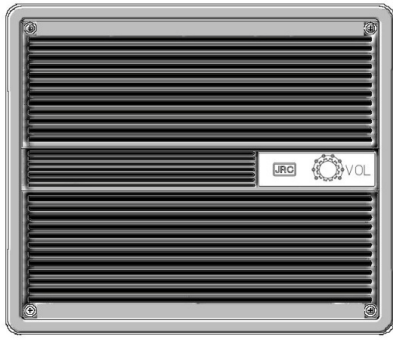

- BTR-155 Wireless speaker microphone



# Contents

<b>Preface</b> .....	<b>vii</b>
<b>Before operation</b> .....	<b>ix</b>
<b>Handling precaution</b> .....	<b>xi</b>
<b>DISTRESS ALERTS</b> .....	<b>xiv</b>
<b>Equipment exterior</b> .....	<b>xvii</b>
<b>Glossary of terms</b> .....	<b>xxiii</b>
<b>1. EQUIPMENT OVERVIEW</b> .....	<b>1-1</b>
1.1 Functions .....	1-1
1.2 Features.....	1-1
1.3 Basic configuration .....	1-2
1.3.1 Basic configuration of the main unit.....	1-2
1.3.2 Options.....	1-2
1.3.3 System configuration .....	1-3
1.4 External dimensions .....	1-4
1.5 Block diagram.....	1-16
<b>2. NAMES AND FUNCTIONS</b> .....	<b>2-1</b>
2.1 Main unit (JHS-800S) and Controller (NCM-980) .....	2-1
2.2 Main displays .....	2-2
2.2.1 Status display .....	2-2
2.2.2 Operating screen .....	2-6
2.2.3 Menu screen .....	2-8
<b>3. INSTALLATION</b> .....	<b>3-1</b>
<b>4. OPERATION</b> .....	<b>4-1</b>
4.1 Operation overview.....	4-1
4.2 Basic communication procedure .....	4-3
4.2.1 Turning ON the power.....	4-3
4.2.2 Turning OFF the power.....	4-4
4.2.3 Communicating with the radiotelephone.....	4-5
4.2.4 Receiving with scanning .....	4-9
4.2.5 Receiving with dual watch .....	4-10
4.2.6 Receiving on triple watch.....	4-11
4.2.7 Using memory channels .....	4-12
4.2.8 Communicating on a private channel .....	4-13
4.2.9 Receiving a weather channel.....	4-14
4.2.10 Changing the channel region.....	4-14
4.2.11 Squelch settings of each channel (preset squelch) .....	4-15
4.3 Basic DSC operations .....	4-16
4.3.1 Routine calls to an individual station.....	4-16
4.3.2 Receiving routine individual calls.....	4-18

4.3.3	Routine group calls .....	4-20
4.3.4	Receiving routine group calls .....	4-21
4.3.5	Communicating with a PSTN subscriber.....	4-22
4.3.6	AIS-linked DSC calls .....	4-25
4.4	Emergency calls (DSC safety/ urgency/ distress calls).....	4-26
4.4.1	Safety or urgency calls to an individual station .....	4-26
4.4.1.1	Special safety individual calls (test calls and position request calls) .....	4-26
4.4.2	Receiving safety or urgency individual calls.....	4-28
4.4.2.1	Receiving special safety individual calls (test calls and position request calls) ....	4-28
4.4.3	Safety or urgency all ships calls .....	4-29
4.4.4	Receiving safety or urgency all ships calls.....	4-30
4.4.5	Distress alerts .....	4-31
4.4.5.1	Quick distress alerts.....	4-31
4.4.5.2	Distress alerts from the menu .....	4-34
4.4.5.3	Receiving distress alerts .....	4-36
4.4.6	Distress relay calls on behalf of someone else (DROBOSE).....	4-37
4.5	DSC call log.....	4-39
4.5.1	Received distress messages.....	4-39
4.5.2	Received other messages .....	4-40
4.5.3	Transmitted messages .....	4-40
4.6	Other features .....	4-41
4.6.1	Notification of registered ships by the AIS.....	4-41
4.6.2	Playback of received voice .....	4-42
4.6.3	Public Address function with an external speaker (option).....	4-45
4.6.4	Intercom.....	4-46
4.6.5	Talk with a wireless speaker microphone .....	4-48
4.6.6	Change river channels using block channel function .....	4-49

## **5. SETTINGS & REGISTRATIONS ..... 5-1**

5.1	Date and time setting .....	5-1
5.2	Own ship position and time setting .....	5-2
5.2.1	Setting for the ship position and the time .....	5-2
5.2.2	Setting priority for the external positioning system.....	5-3
5.3	Settings for each control panel.....	5-4
5.3.1	LCD adjustment.....	5-4
5.3.2	Sound settings.....	5-5
5.3.3	User key assignment .....	5-6
5.3.4	Name the device.....	5-7
5.3.5	Menu shutdown timer setting.....	5-8
5.3.6	Setting the handset.....	5-8
5.3.7	Setting the channel area.....	5-9
5.3.8	Setting the S meter display.....	5-9
5.4	Making contact lists .....	5-10
5.5	Advanced settings for DSC .....	5-12
5.5.1	Automatic acknowledgement.....	5-12
5.5.2	Disabling receiving sound for routine and safety calls .....	5-13
5.5.3	Medical/Neutral use setting for urgency calls.....	5-13

5.5.4	Expanded MMSI registration.....	5-14
5.5.5	Registering the ship's group ID.....	5-14
5.5.6	Setting the inactivity timeout timer .....	5-15
5.5.7	Setting the Auto channel change .....	5-15
5.6	Other settings .....	5-16
5.6.1	Enabling the AIS function.....	5-16
5.6.2	Setting printer property .....	5-16
5.6.3	Setting of the controller start.....	5-17
5.6.4	Registering waypoints for block channel function.....	5-18
<b>6.</b>	<b>MAINTENANCE &amp; INSPECTION .....</b>	<b>6-1</b>
6.1	General maintenance & inspection .....	6-1
6.2	Self diagnosis inspection.....	6-2
6.3	BAM alert indication.....	6-4
6.3.1	New BAM alert information .....	6-4
6.3.2	Displaying the current alert information .....	6-5
6.3.3	Alert list .....	6-6
6.4	Checking the setup condition .....	6-8
6.4.1	System information .....	6-8
6.4.2	Software version .....	6-9
6.4.3	Certification mark.....	6-9
6.5	DSC AF inspection .....	6-10
6.6	Troubleshooting .....	6-11
6.6.1	Procedures for locating malfunctions.....	6-11
6.6.2	Guide to locating faults .....	6-12
6.6.3	Consumables .....	6-13
6.6.4	Repair units/parts .....	6-13
6.6.5	Regular replacement parts.....	6-13
<b>7.</b>	<b>AFTER-SALES SERVICE.....</b>	<b>7-1</b>
<b>8.</b>	<b>DISPOSAL .....</b>	<b>8-2</b>
<b>9.</b>	<b>SPECIFICATIONS.....</b>	<b>9-1</b>
9.1	JHS-800S Marine VHF Radiotelephone.....	9-1
9.2	Channel assignment tables .....	9-4
9.3	Options .....	9-9
9.4	Peripheral interfaces.....	9-10
9.5	Software license information .....	9-20
<b>10.</b>	<b>OPTIONS OPERATION .....</b>	<b>10-1</b>
10.1	Handset connection box (NQE-1845B/1846/1847B) .....	10-1
10.2	AC/DC power supply (NBD-965).....	10-2
10.3	Printer (RP-D10).....	10-3
10.4	Remote control from ECDIS or Marine radar .....	10-5



# Glossary of terms

This section contains general and DSC terms related to this equipment.

## ● General terms

### **AIS**

Automatic Identification System  
Equipment that transmits a ship's Maritime Mobile Service Identity number, ship name, ship position, speed, orientation, and other information to and from other ships. AIS equipment is required on some ships by the International Convention for the Safety of Life at Sea (SOLAS)

### **ATIS**

Automatic Transmitter Identification System  
This is used for notification of the radio station ID to receivers when using European inland waterway (IWW) channels.

### **BAM**

Bridge Alert Management

### **CAM**

Central Alert Management

### **CCG**

Canadian Coast Guard

### **DSC**

Digital Selective Calling  
Used in routine calls, safety and urgency calls, and distress alerts for rescue request.

### **GMDSS**

Global Maritime Distress and Safety System

### **GPS**

Global Positioning System

### **IMO**

International Maritime Organization

### **Intercom**

Wired communications equipment or functionality

### **ITU**

International Telecommunication Union  
The leading United Nations agency for information and communication technologies. Establishes conventions and regulations for all electrical communications. It contains internal organizations such as ITU-R and ITU-T.

### **ITU-R**

The International Telecommunication Union (ITU) radio communications department

### **IWW**

Inland Waterway

### **LT**

Local Time

### **MMSI**

Maritime Mobile Service Identity  
The 9-digit Maritime Mobile Service Identity number assigned to each ship and coast station.

### **NMEA**

National Marine Electronics Association  
Maritime equipment transmission standard established by the National Marine Electronics Association

### **NNSS**

Navy Navigation Satellite System  
Doppler based satellite positioning system operated by the United States Navy.

### **PA**

Public Address  
Sound amplification equipment  
In this radiotelephone equipment, it is a function for using an external public address.

### **PTT (Push To Talk)**

Handset button to talk

### **RCC**

Rescue Co-ordinate Center  
In Japan, the Japan Coast Guard.

### **RMS**

Remote Maintenance System  
Transmits ship equipment information temporarily stored in VDR via Inmarsat to land, for use in maintenance and management of radio equipment.

### **RR**

Radio Regulations  
Intergovernmental treaty text of the ITU

**SAR Convention**

International Convention on Maritime Search and Rescue

**SOLAS Convention**

The international convention applied to all ships engaged on international voyages. A safety certificate is issued if the conditions of this convention are satisfied.

**SQL (Squelch)**

A function that acts to suppress the audio output of a receiver in the absence of a sufficient radio strength signal.

**Station**

A radio station, or a control terminal for radio equipment

**USCG**

United States Coast Guard

**UTC**

Universal Time Coordinated

**VDR**

Voyage Data Recorder

After a maritime accident, recovered to analyze the recorded data (speed, rudder, bridge conversation, VHF audio, etc.) to determine the cause of the accident.

It can also transmit navigation management data regularly via Inmarsat to land.

**VHF**

Very High Frequency (30 - 300MHz)

**VOL**

Loudspeaker volume

**WRC**

World Radiocommunication Conference

**WMO**

World Meteorological Organization

**WKR**

Watchkeeping Receiver

Dedicated receiver for CH70 to watch the DSC signals.

## ● DSC terms

---

### Address

General term for Maritime Mobile Service Identity number (MMSI)  
This equipment uses TO/FROM to distinguish between the sender and receiver. It also means the SELF-ID (own ship MMSI) and DIST-ID (MMSI of a ship in distress).

### Category

Message code indicating priority of the call. It contains types as below.

- ROUTINE.. General calls for routine works
- SAFETY .... Safety communications call
- URGENCY Urgent communications call
- DISTRESS Distress alert

### DROBOSE

Distress relay call (to individual or to area) on behalf of someone else who is in distress.

### EOS (End Of Sequence)

Termination code appended to the call messages.  
It contains types as below.

- EOS ..... End of sequence
- ACK RQ .... Acknowledgement request
- ACK BQ .... Acknowledgement responding to the ACK RQ

### ECC (Error Check Character)

*Error check code appended to the end of call messages.*  
This is not normally displayed, but if an error occurs, one of the following will be displayed.

- ECC ERROR..... Message error
- EX ECC ERROR... Expansion message error

### Format

Message code indicating type of call. It contains types as below.

- Individual call ..... Individual call
- Individual ACK ..... Acknowledgement response to individual call
- Individual NACK .... Negative acknowledgement response to individual call
- Semi/auto call ..... PSTN connection call
- Semi/auto ACK ..... PSTN call acknowledgement
- Semi/auto NACK ... PSTN call negative acknowledgement
- Group call ..... Call to ships having common interest
- All ships call ..... Call to all ships
- Distress ..... Distress alert

### Nature of Distress

Message code indicating type of distress when a distress call is issued.

It contains types as below.

- FIRE ..... Fire, explosion
- FLOODING..... Flooding
- COLLISION ..... Collision
- GROUNDING ..... Grounding
- LISTING ..... Risk of ship capsizing
- SINKING ..... Sinking
- DISABLED..... Ship inoperable/adrift
- UNDESIGNATED .... Undesignated distress
- ABANDONING ..... Abandoning ship
- PIRACY ATTACK..... Piracy attack
- MAN OVERBOARD .Man overboard (MOB)
- EPIRB EMISSION .... DSC VHF EPIRB reception

### Polling

Polling is a feature for routine calling. It is used, for example, to confirm whether a ship is existing within radio range when a coast station requests navigational information to the ship.

### PSTN (Public Switched Telephone Network)

General fixed landline telephone network.

### Reason

Message code indicating reason for negative acknowledgement response.

- NO REASON..... No reason
- CONGESTION ..... Maritime information exchange center congested
- BUSY ..... Busy
- QUEUE ..... Queued
- BARRED ..... Station barred
- NO OPER..... No operator
- TEMP NO OPER... Temporarily no operator
- EQP DISABLED .... Equipment disabled
- UNABLE CH..... Indicated channel cannot be used
- UNABLE MODE.... Indicated mode cannot be used

## Subject

Message code clarifying communication contents when sending an urgency call to all ships.

When sailing dangerous waters, such as political instability, these call messages with the following information are used.

- Neutral ship..... In accordance with ITU resolution 18 (Mob-83), inform all ships that own ship is of neutral nationality.
- Medical TRNSP .... Inform all ships that own ship is performing medical transportation, and is protected under the 1949 Geneva Convention.

## Type

Main contents of call message.

Normally, the 1<sup>st</sup> telecommand will be indicated, but for a distress related call, it may also take into account the Format and the EOS. Displayed when message is received, as well as in LOG.

- ALL MODES RT ..... All F3E/G3E radiotelephones
- SEMI-DUPLEX RT... Semi-Duplex F3E/G3E radiotelephones
- POLLING ..... Polling
- DATA ..... Data transmission
- POSITION RQ ..... Ship position request
- SHIP POSITION ..... Ship position notification
- TEST ..... Safety test call
- UNABLE TO COMPLY.... Negative acknowledgement
- DISTRESS..... Distress message
- DISTRESS ACK ..... Acknowledgement of distress message
- DISTRESS RELAY .. Distress relay message
- DIST-RELAY ACK.... Acknowledgement of distress relay message

## Work CH

Message code indicating a work channel to communicate using radiotelephone.

# 1. EQUIPMENT OVERVIEW

## 1.1 Functions

This equipment includes marine VHF radiotelephone, Class-A DSC and DSC watchkeeping receiver required as the Global Maritime Distress and Safety System (GMDSS). It is designed as an integrated compact and lightweight unit of the RF and control circuits, including the optional controller, for easy installation in non-regulated ships under 300 tons, as well as in regulated ships (IMO regulated passenger ships and cargo vessels over 300 tons).

This equipment has functions such as the DSC (digital selective calling) for routine calls or distress alert, recording and playback function of the receiving voices, an easy-to-operate self-diagnosis function, and so on. Additionally, various optional functions are available, such as a public address function to announce onboard using the handset and the optional external speaker, an intercom function for communication between the main unit and/or controllers, and a DSC calling function using other ships information input from the AIS (automatic Identification system).

## 1.2 Features

- Compliant with the ITU Radio Regulations (RR), the IMO performance standards, and the ITU-R recommendations.
- Contains all channels specified in the ITU Radio Regulations (RR).
- In addition to channels specified in the ITU Radio Regulations (RR), this equipment also provides USA, Canada, European inland waterway (IWW), and weather channels. It also allows the use of up to 200 private channels.
- Contains ATIS (Automatic Transmitter Identification System) for river channels of IWW mode.
- The compact and lightweight package enables easier to install in the limited space.
- This equipment becomes operable within 5 sec after powering on so it is ready immediately, even if power failure occurs.
- The included handset has high performance dustproof and waterproof (IP66) to use under various conditions such as outside on the deck of a ship.
- Wide angle LCD allows easy viewing and enables to install in a variety of positions for easy viewing and operability.
- The backlight of the LCD and panel buttons has the dimmer control with very wide range, and allows to operate even under the circumstance in the straight/back light or in the dark without interference while keeping night watch.
- The touch screen provides the specific operation buttons on each screen and allows intuitive easy operation.
- The DSC has the automated procedure mentioned in the Recommendation ITU-R M.493 to supply the easy operation such as the suitable menu/indication for the ongoing procedure. Therefore every DSC calls from routine calls until distress alert can be operated easily.
- When in distress, the DSC can send the distress message with the expanded position data containing the digits up to 1/10000 of minutes for both latitude and longitude to make search and rescue operation by the RCC easier.
- The received voice recording and playback function enables later confirmation or temporary saving of communications.
- An advanced digital audio amplifier with a built-in loudspeaker provides 6 W max. And also the sound is selectable by the equalizer for clear sound depending on the scene.
- By using the optional Bluetooth type wireless speaker microphone allows radiotelephony operation far from the marine VHF radiotelephone or VHF controller.
- By connecting to the our ECDIS/ RADAR, this marine VHF radiotelephone can be operate from them, e.g. to call the vessels indicated as the AIS target on their screen via DSC.
- Daily maintenance and inspections are easy to do by using the simple to operate self-diagnosis function.
- Besides printers and GPS, other peripherals such as the AIS, the VDR, and/or remote maintenance systems (RMS) can be connected to this equipment.

## 1.3 Basic configuration

### 1.3.1 Basic configuration

No.	Product Name	Model Name	Qty	Notes
1	Marine VHF Radiotelephone	JHS-800S	1	IP56 equivalent
2	Handset	NQW-980	1	Includes the cradle
3	Power cable	CFS-810	1	For power supply, 2.5 m
4	Accessory cable	CFS-820	1	For GPS and VDR, 2.5 m
5	Bridge card	7ZPJD0741A	1	
6	Spare fuse	0997015.WXN	2	For the power cable
7	Instruction Manual	7ZPJD0714B	1	Not included in the main package

### 1.3.2 Options

No.	Product Name	Model Name	Notes
1	TRX Antenna	7ABJD0004	1.29m Dipole type
2	WKR Antenna	7ABJD0004	1.29m Dipole type
3	Antenna mounting bracket	MPBX41928A	Used for each antenna
4	Coaxial connector	N-P-10U	
5	AC/DC Power supply	NBD-965	IP22 equivalent (with protective covers)
5-1	Power connector cover	7ZZJD0121	
5-2	Signal connector cover	7ZZJD0122	
6	Desktop kit	MPBX50190	For Radiotelephone
7	Controller	NCM-980	Upto 4 units available, IP56 equivalent
7-1	CAN cable	CFS-830	Specific controller cable, 5 m
7-2	Desktop kit	MPBX50191	For the controller
8	Handset	NQW-980	Waterproof type/ IP66 equivalent
8-1	Handset	7UMJD0020	Handset only (without cradle)
8-2	Cradle	7ZJJD0004	Cradle only
8-3	Handset extension cable	CFQ-5530	3 m
8-4	Handset extension cable	CFQ-5397	10 m
8-5	Handset extension cable	CFQ-5398	20 m
9	Connection box	CQD-10	16 terminals (code: CQD-10DN2)
10	AUX cable	CFS-840	For Handset C/B and External speaker, 2.5 m
11	Handset connection box	NQE-1845B	For Wing console, waterproof type/ IP66 equivalent
12	Handset connection box	NQE-1846	For Wing, waterproof type/ IP66 equivalent
13	Handset connection box	NQE-1847B	Indoor flush mount type
14	Wireless speaker microphone	BTR-155	Bluetooth type
15	Sensor LAN switch	NQA-2443	Switching HUB
16	Printer	RP-D10	IP22 equivalent (with a protective cover)
16-1	Roll paper	TP-B10CH	80 mm x $\phi$ 80 mm, 65 m
16-2	Power supply	NBG-980	DC24 V output
17	External speaker	NVS-423R	Wall mount type
18	External speaker	NVS-823R	Flush mount type
19	Handmic	NVT-140L	
20	Distress message controller	NCH-3210	Providing LAN ports

1.3.3 System configuration



JHS-800S Marine VHF Radiotelephone



NBD-965 Power Supply

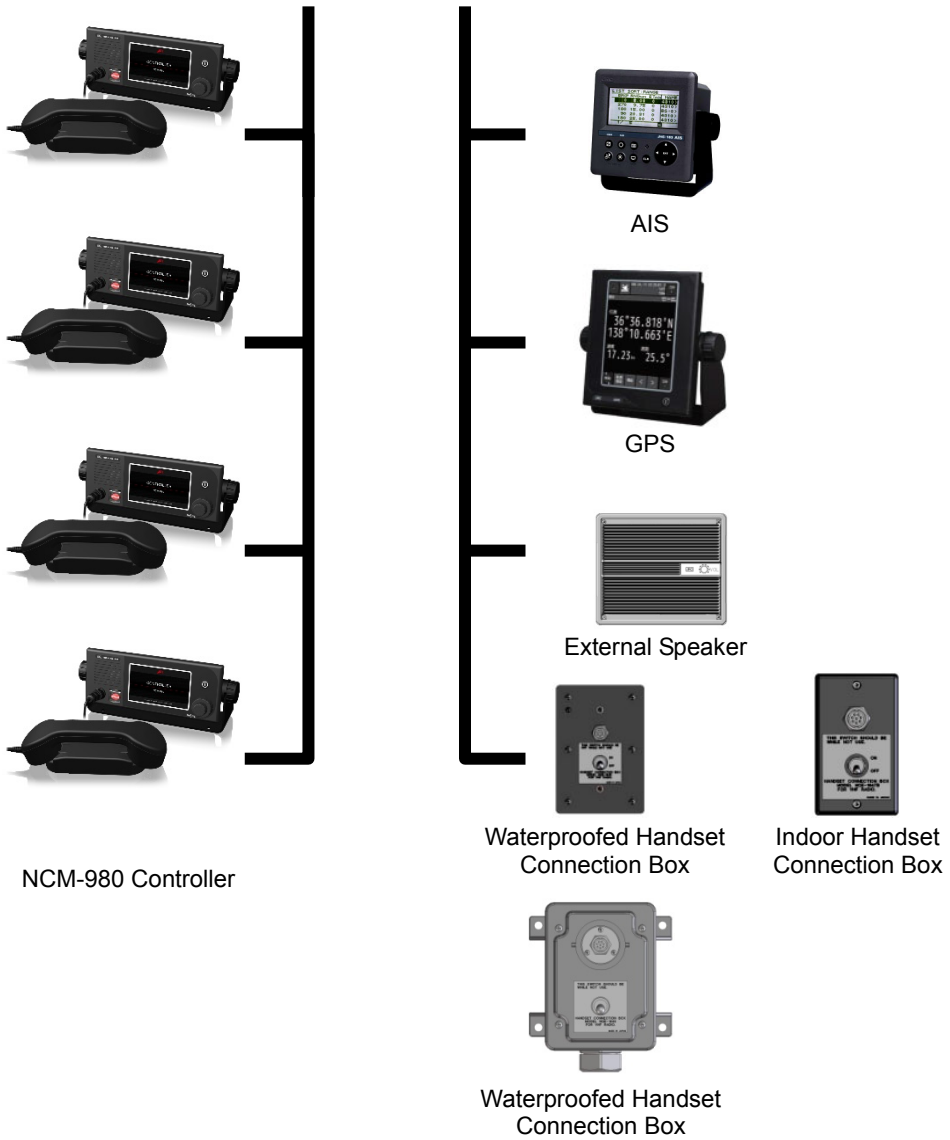

NCM-980 Controller

Waterproofed Handset Connection Box

Indoor Handset Connection Box

Waterproofed Handset Connection Box

\* The radiotelephone can also be used with connected remote maintenance systems, BAM, VDR and printer.

## 1.4 External dimensions

Below are the external dimensions of each unit.

### (1) Marine VHF Radiotelephone (JHS-800S)

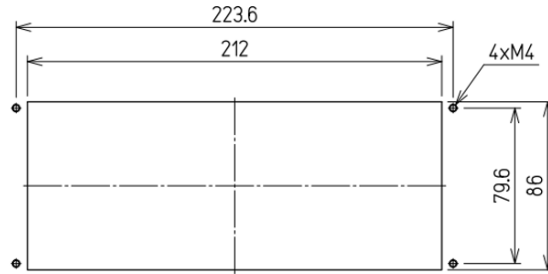
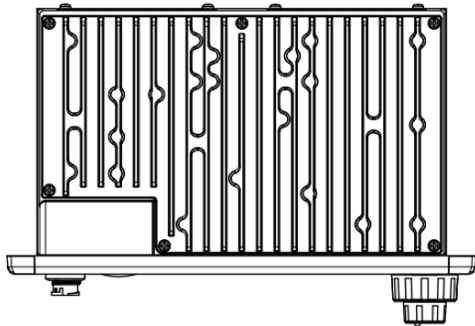

Mounting surface cut dimensions

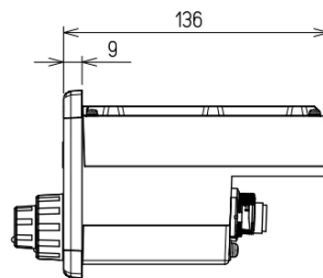
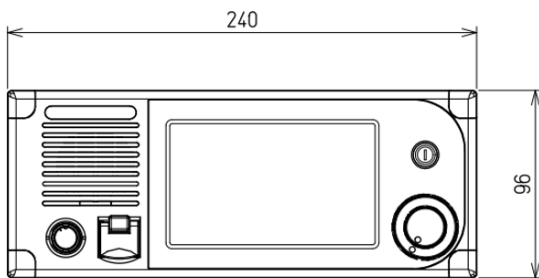

Unit: mm  
Weight: Approx. 2.1 kg  
Color: Munsell N2.5

### (2) Handset (NQW-980)

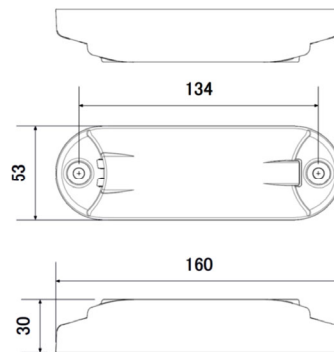
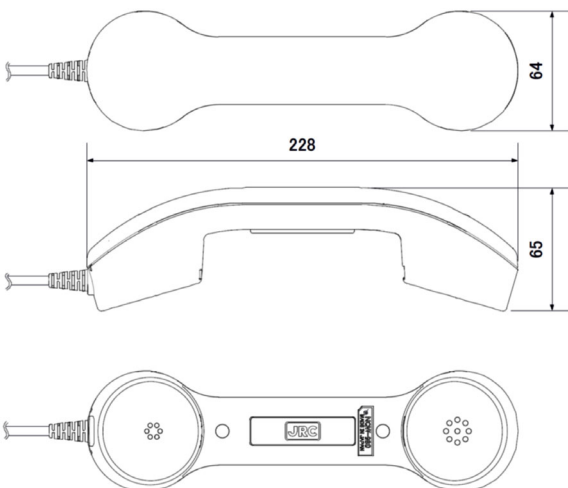

Unit: mm  
Weight: Approx. 0.45 kg  
Color: Munsell N2.5



(3) Antenna (7ABJD0004) and Mounting bracket (MPBX41928A)

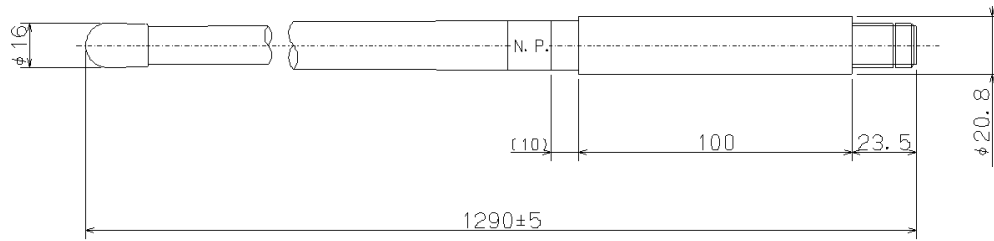

Unit: mm  
Weight: Approx. 0.3 kg

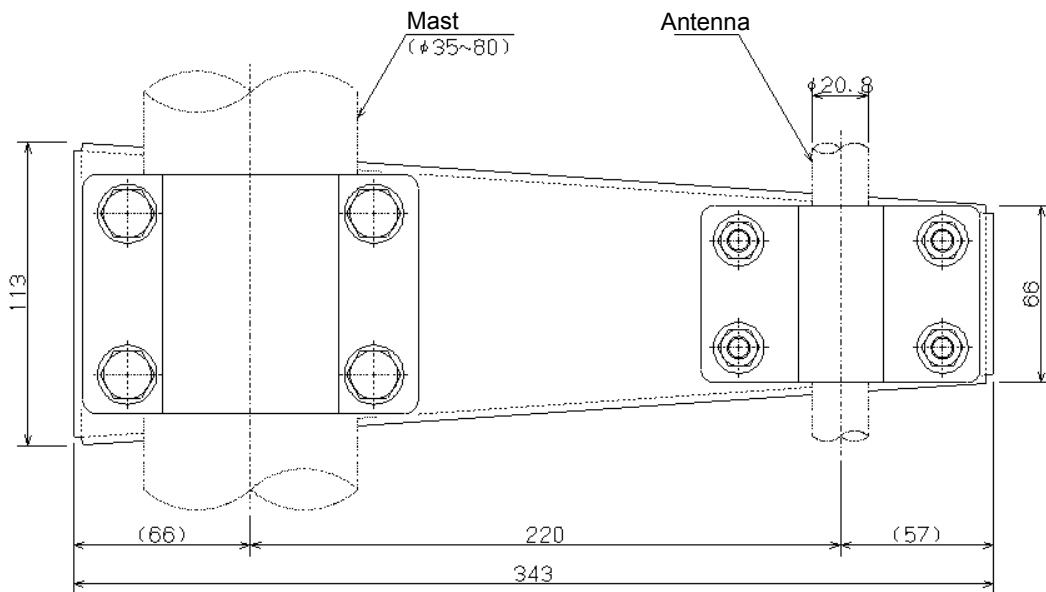
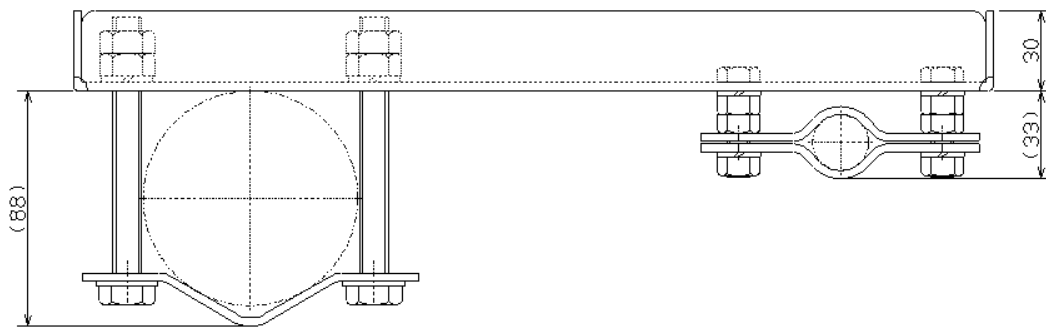

Unit: mm  
Weight: Approx. 2.1 kg

(4) AC/DC power supply (NBD-965)

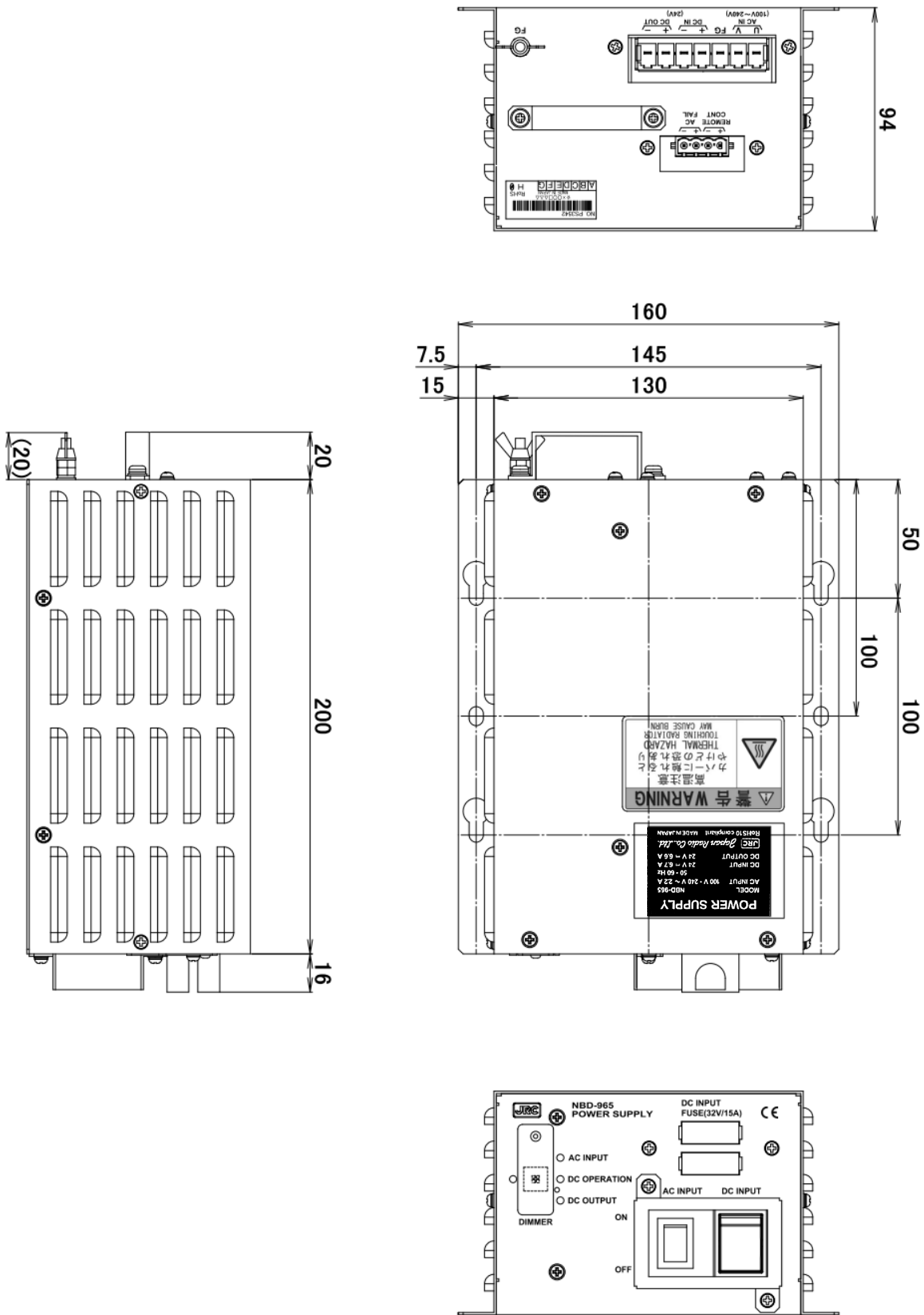

(5) Controller (NCM-980)

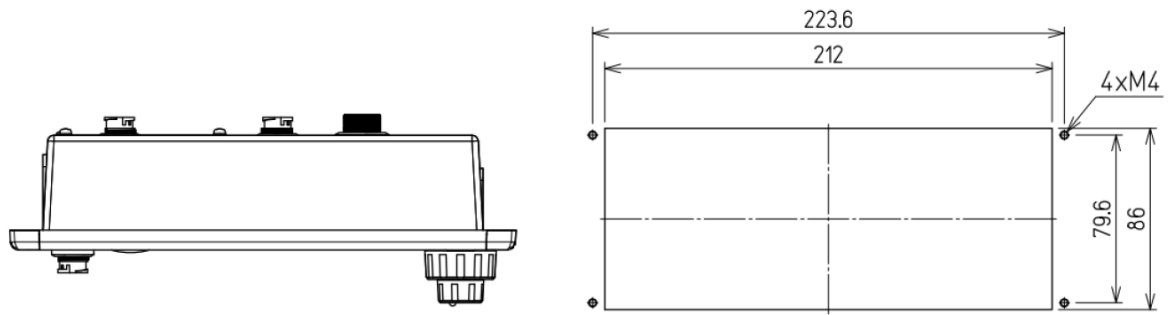

Mounting surface cut dimensions

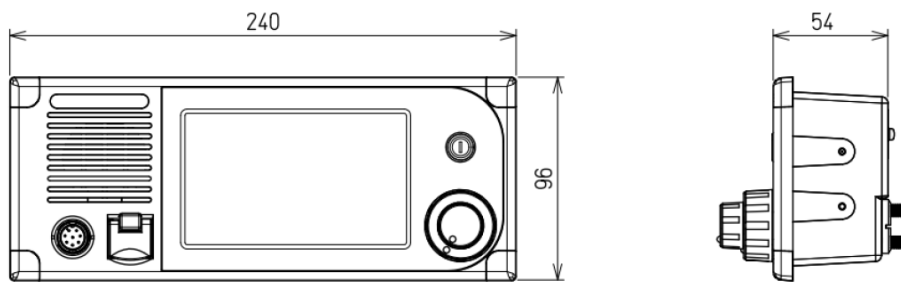

Unit: mm  
 Weight: Approx. 0.9 kg  
 Color: Munsell N2.5

(6) Connection box (CQD-10)

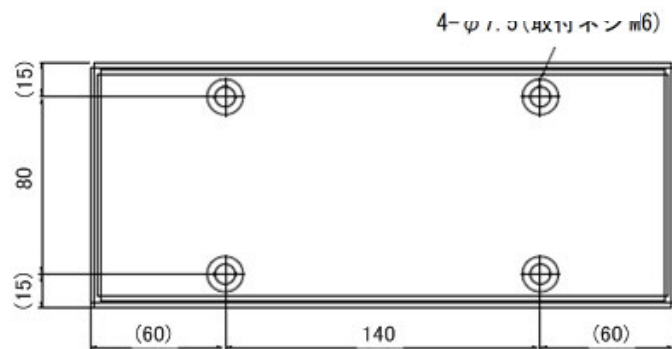
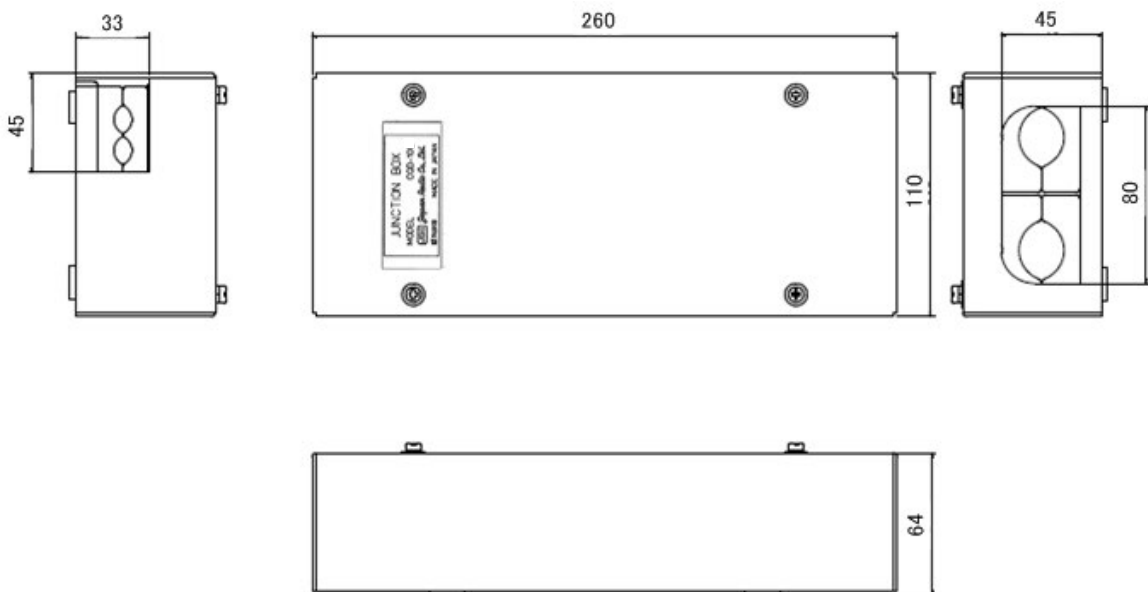

Unit: mm  
 Weight: Approx. 1.1 kg  
 Color: Munsell N2.5G7/2

(7) Handset connection box (for wing console installation) (NQE-1845B)

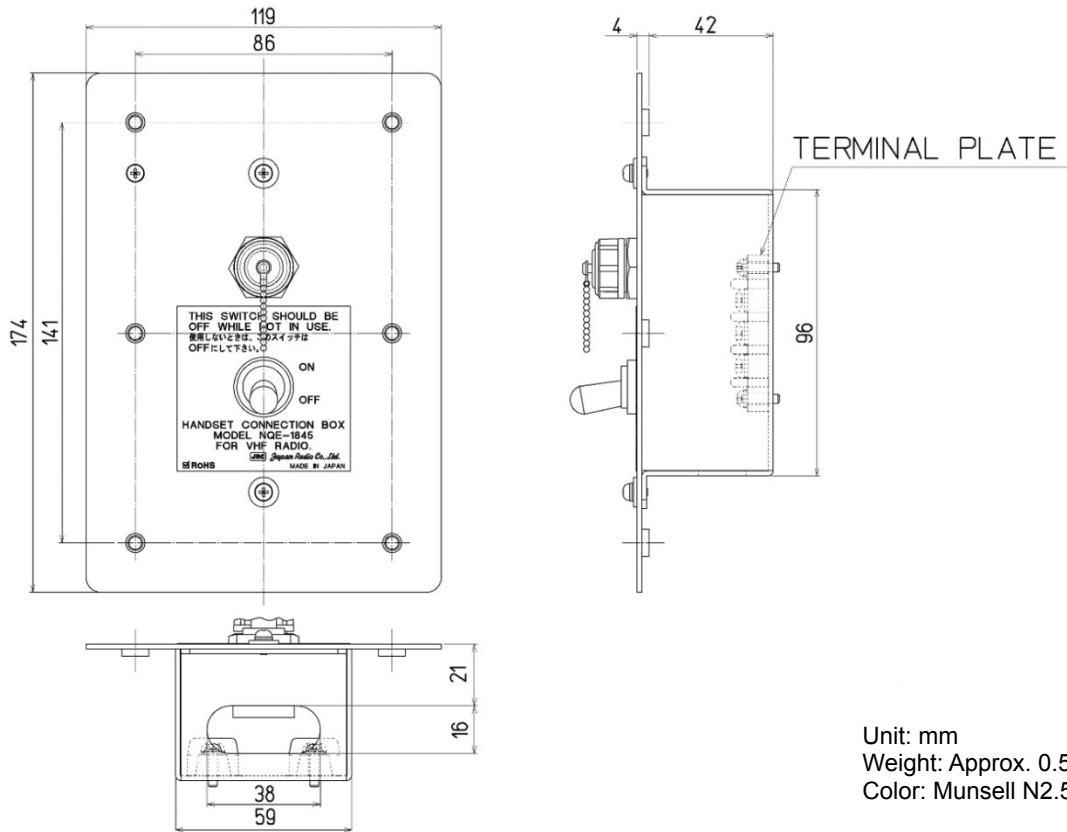

Unit: mm  
 Weight: Approx. 0.5 kg  
 Color: Munsell N2.5

(8) Handset connection box (for wing installation) (NQE-1846)

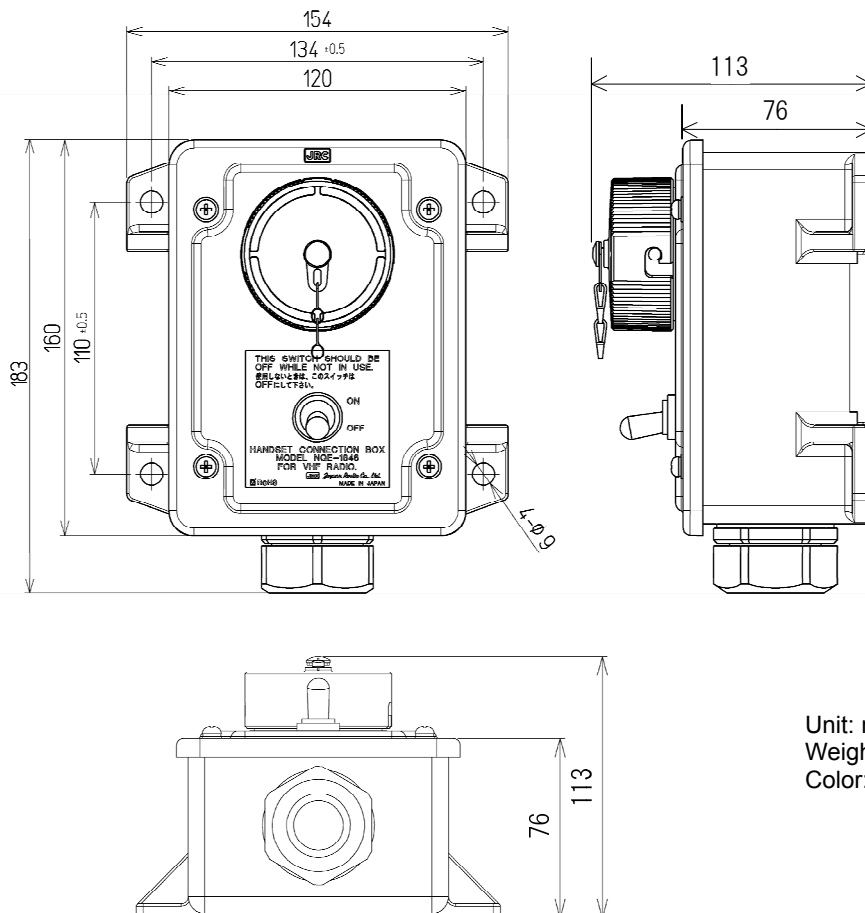

Unit: mm  
 Weight: Approx. 1.1 kg  
 Color: Munsell 7.5BG7/2

(9) Handset connection box (for indoor flush mounting) (NQE-1847B)

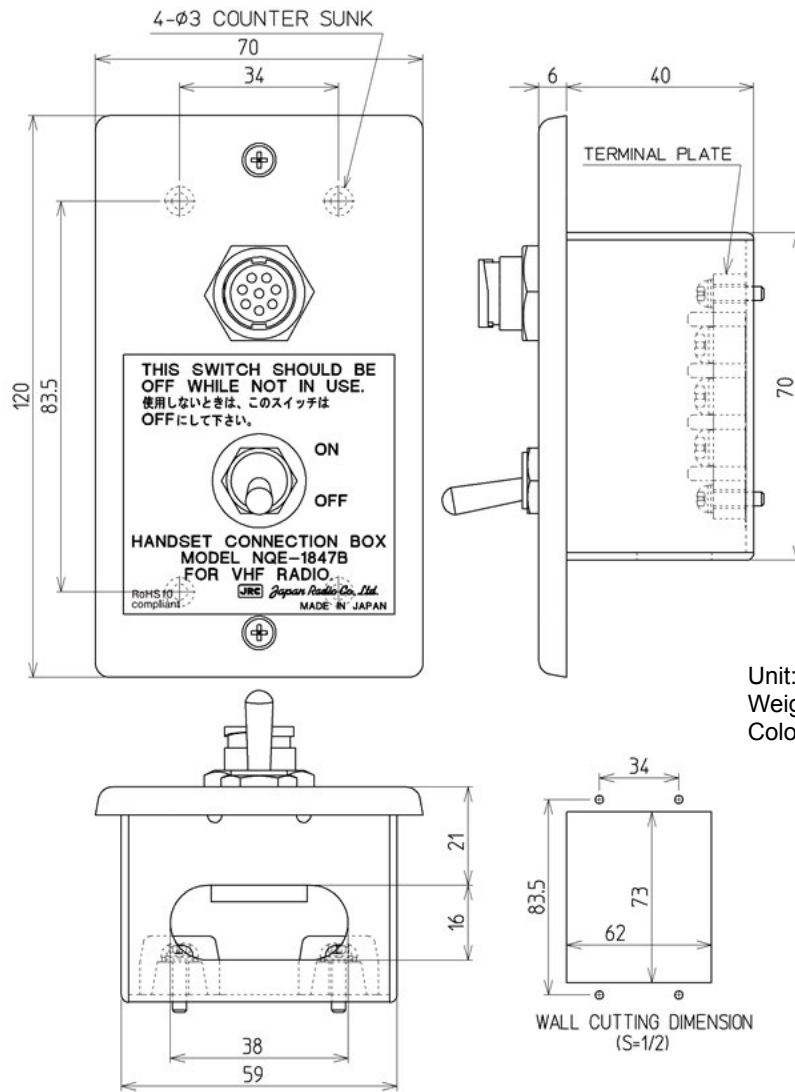

(10) Handmic (NVT-140L)

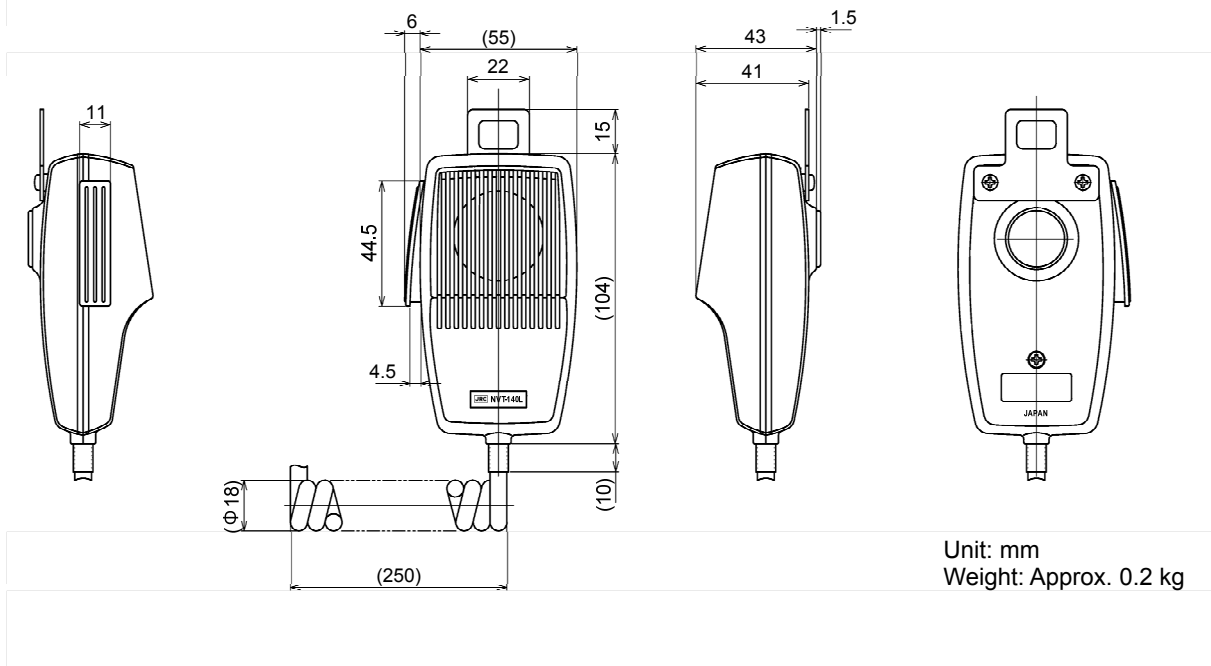

(11) Sensor LAN switch (NQA-2443)

---

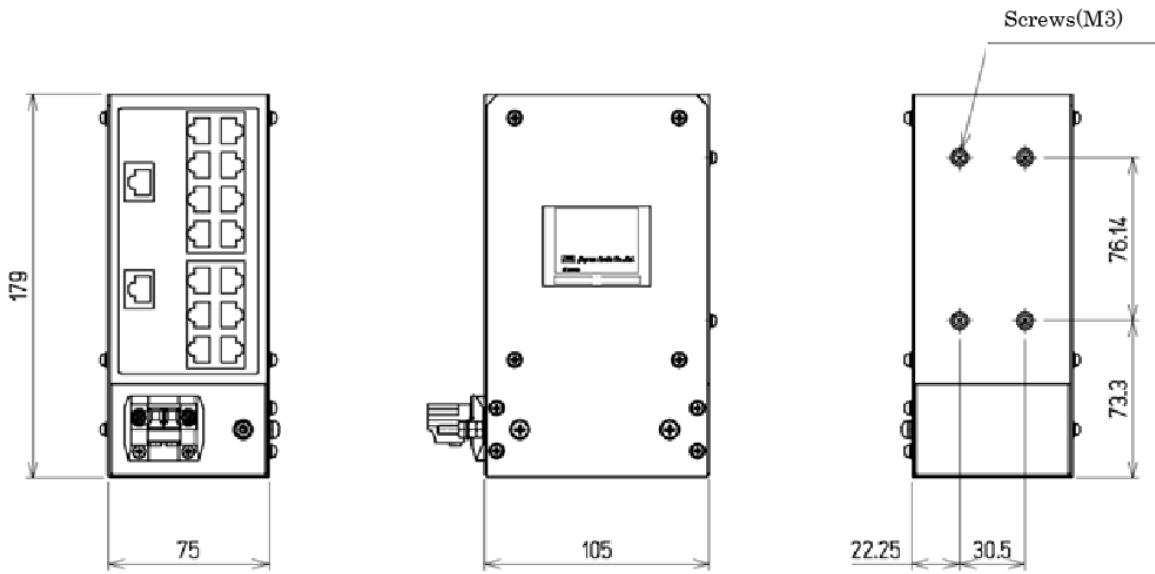

Units: mm  
Weight: Approx. 1.5 kg  
Color: Munsell N2.5

(12) Printer (RP-D10)

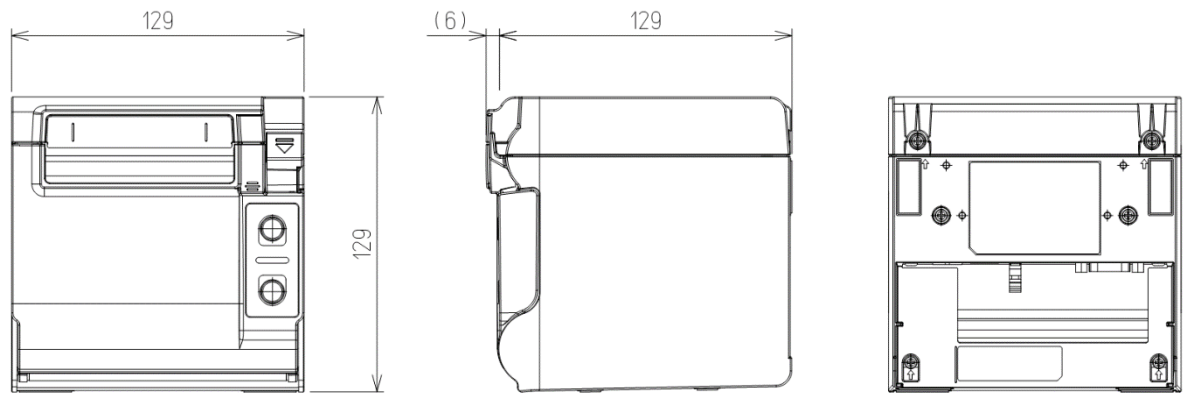

Unit: mm  
 Weight: Approx. 0.85 kg  
 Color: Munsell N2.5

(13) Power supply (NBG-980) \*For printer

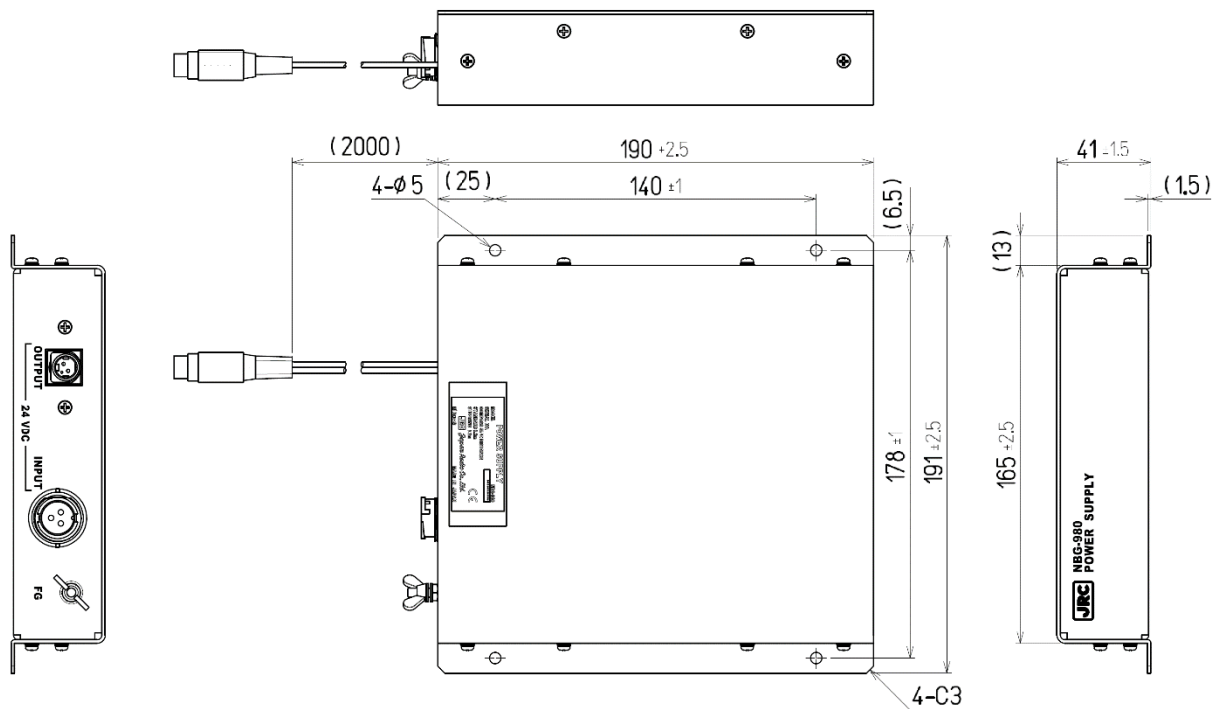

Unit: mm  
 Weight: Approx. 1.0 kg  
 Color: Munsell N2.5

Equipment Overview

(14) External speaker (NVS-423R) \*Wall mount type

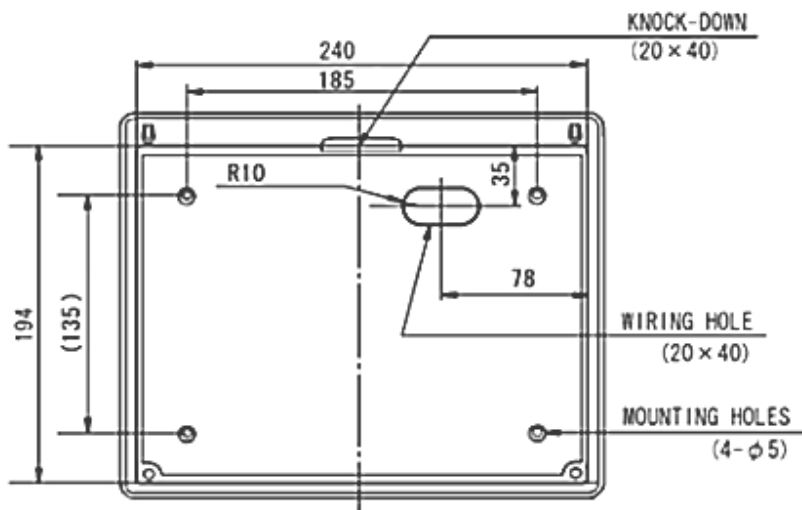
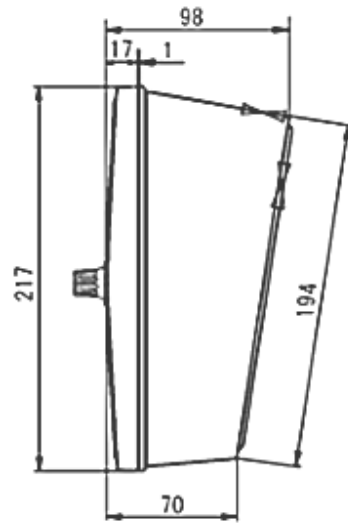
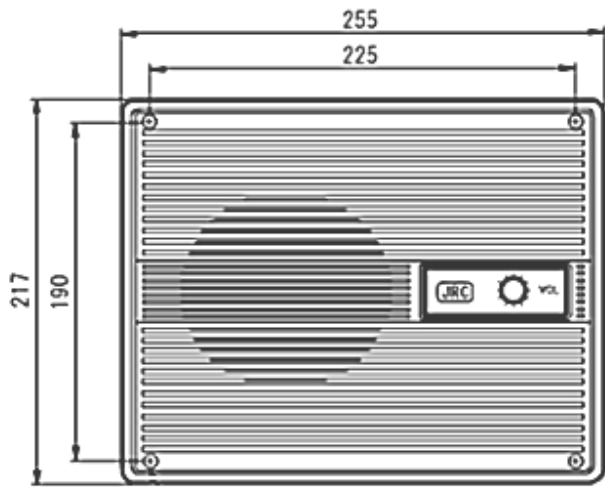

Units: mm  
Weight: Approx. 1.1 kg  
Color: Munsell N4 (Panel)  
Munsell N7 (Case)



(15) External speaker (NVS-823R) \*Flush mount type

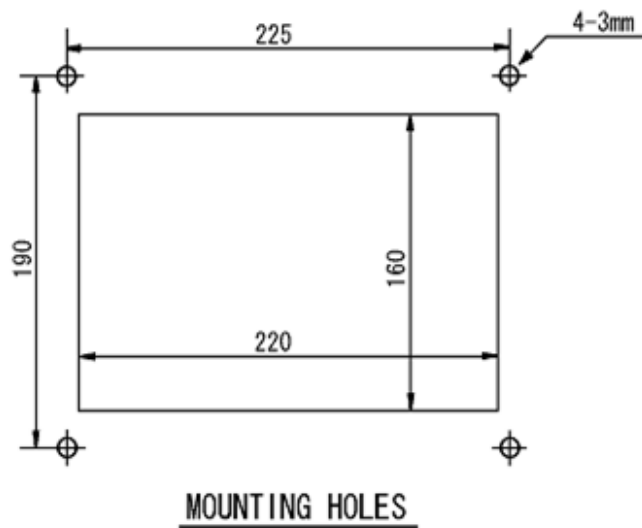
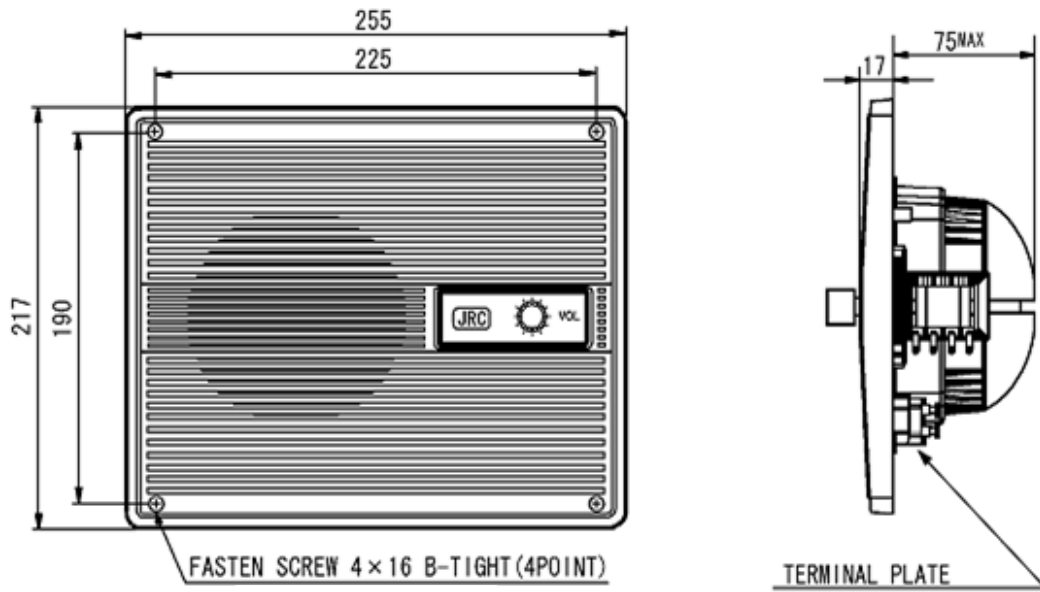

Units: mm  
 Weight: Approx. 1.0 kg  
 Color: Munsell N4

(16) Integrated console (JHS-800S-CON)

---

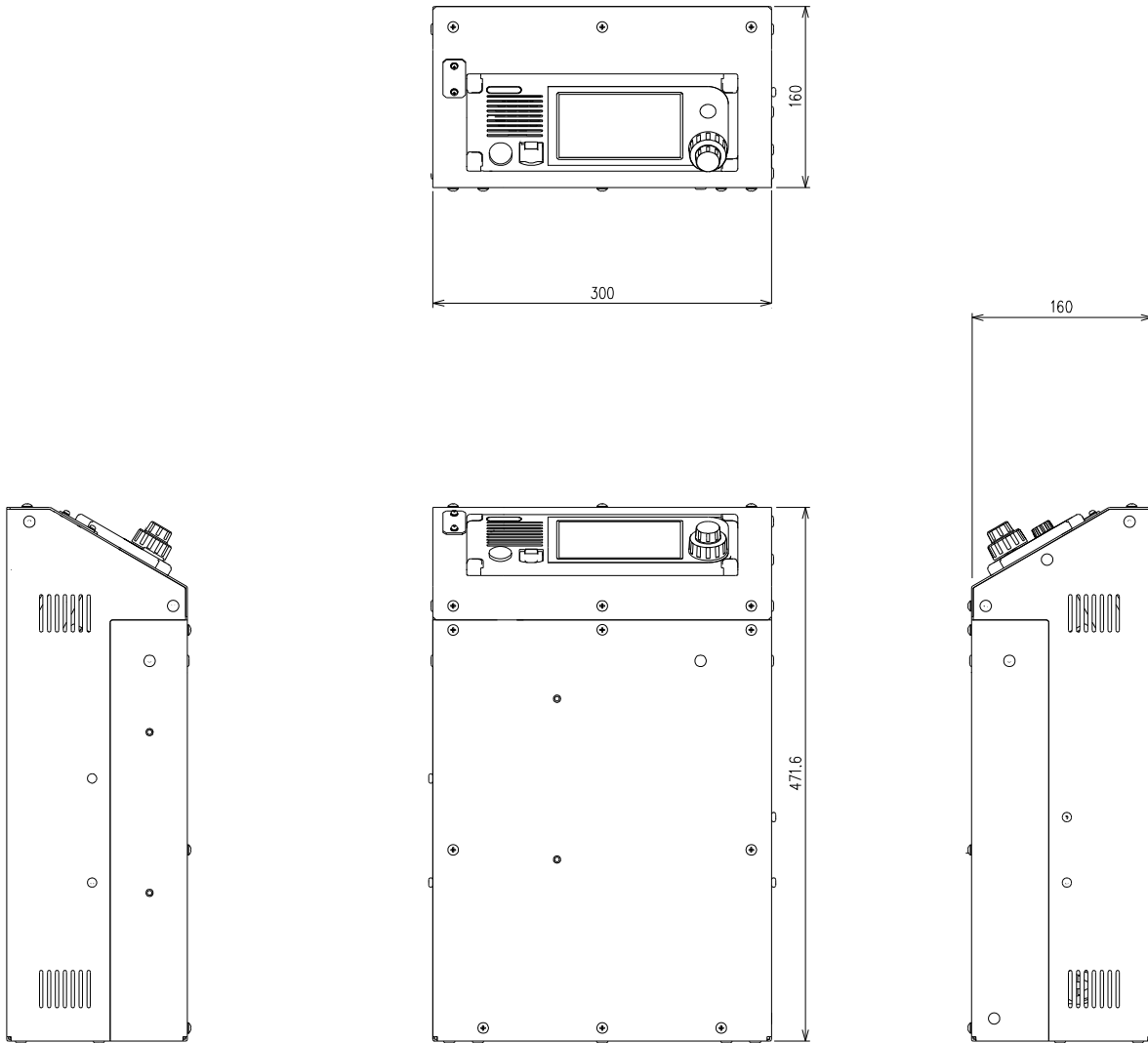

Units: mm  
Weight: Approx. 15.0 kg  
Color: Munsell N2.5

(17) Integrated console (JHS-800S-CON) \*With NZL-1 Emergency light

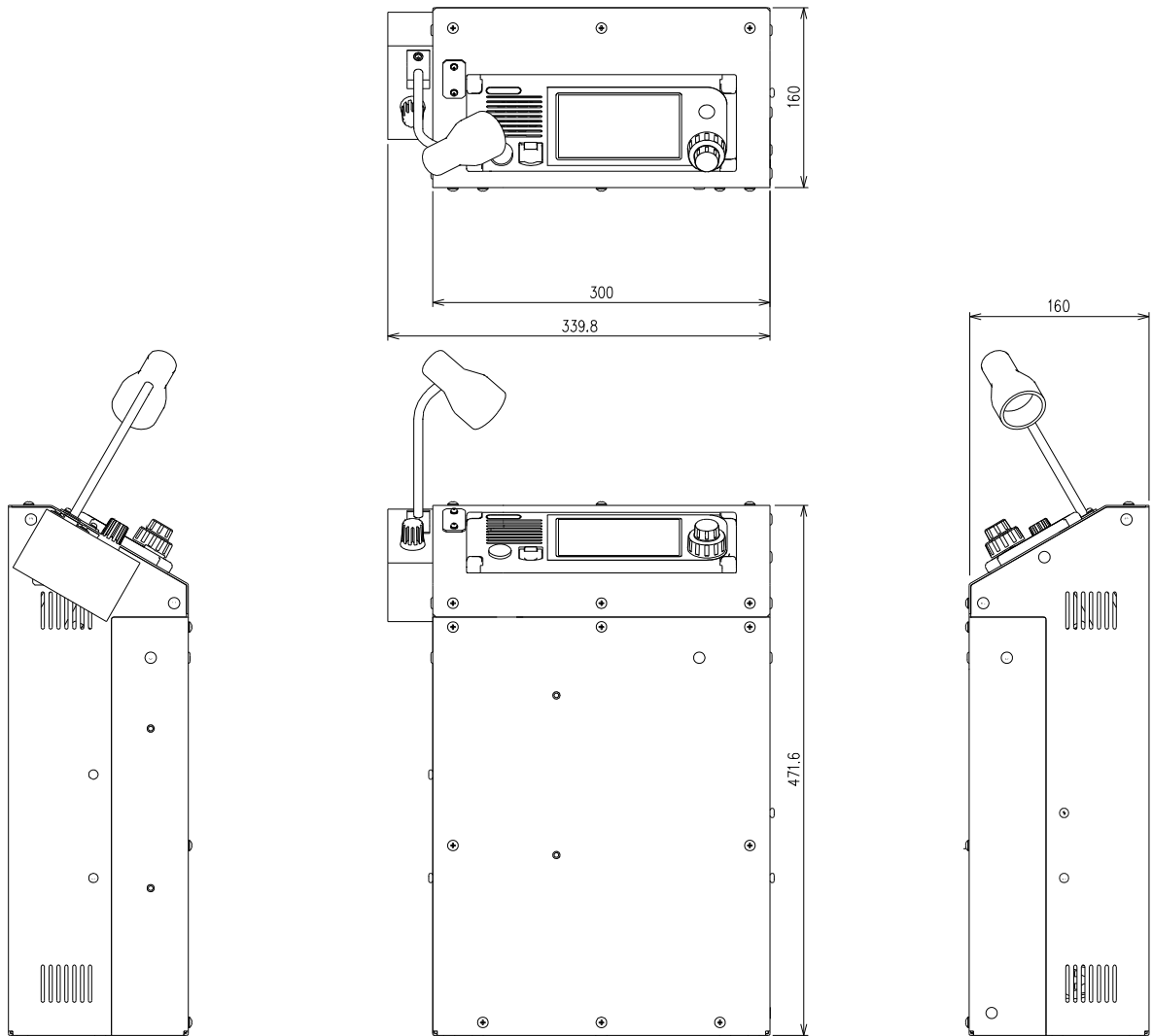

Units: mm  
Weight: Approx. 15.5 kg  
Color: Munsell N2.5

# 1.5 Block diagram

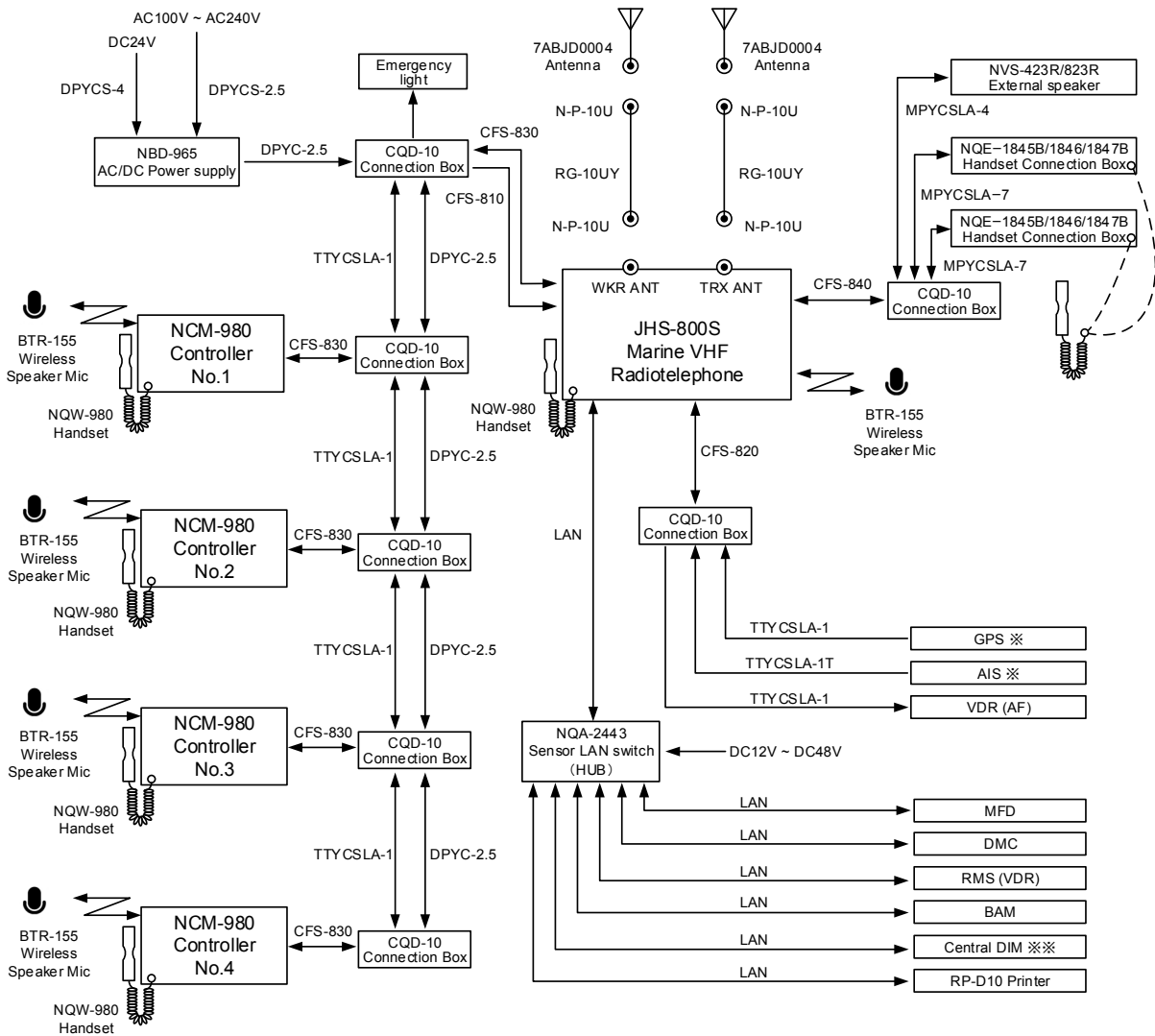

Note)  
 ※ Connection via LAN is also available.  
 ※※ Connection using TTYCSLA-1 is also available.  
 (Only one system among AIS or Central DIM is selectable.)

## 2. NAMES AND FUNCTIONS

### 2.1 Marine VHF (JHS-800S) and Controller (NCM-980)

The names and their functions are described below.



**1. Internal loudspeaker**

**2. Handset connector**

**3. DISTRESS button**

When in distress, sends a DSC distress alert after pressing for 3 seconds.

**4. Color LCD display/ Touch panel**

Touch the buttons on the screen for operation.

**5. PWR button**

To power on press this button for 1 second. And to power off press this button and follow the menu appeared on the screen.

**6. Squelch control**

Adjusts squelch level.

**7. Volume control**

Adjusts built-in loudspeaker volume.

**8. Handset**

Press and hold the PTT key to talk.

**9. Cradle (for handset)**

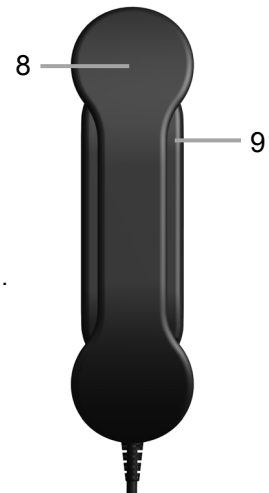

## 2.2 Main displays

The LCD screen changes according to current conditions. This section describes the status display, menu screen, and the screen for DSC messages.

### 2.2.1 Status display

(1) Parts for display

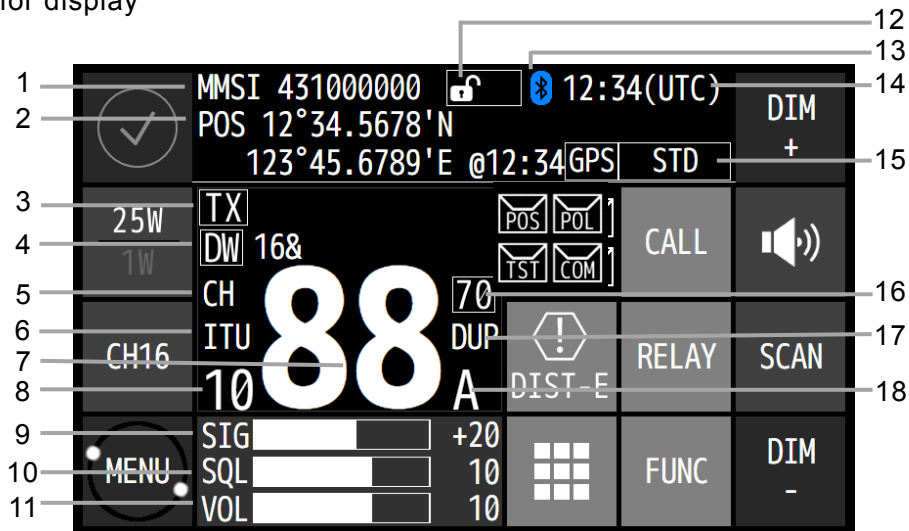

1	Indicates the ship's MMSI.	10	Indicates the level of the squelch or preset squelch. Additionally, indicates highlight when the squelch is opened.
2	Indicates own ship's position and that time.	11	Indicates the level of the loud speaker volume.
3	Indicates transmitting information. <ul style="list-style-type: none"> <li>• Transmitting: TX</li> <li>• Bad VSWR at TX: TXVSWR</li> <li>• PLL unlock: UNLOCK</li> </ul>	12	Indicates the status of the access rights. <ul style="list-style-type: none"> <li>• Not occupied: </li> <li>• Occupied: </li> </ul>
4	Indicates the current scanning condition. <ul style="list-style-type: none"> <li>• Scanning:  16&amp;</li> <li>• Dual Watch: DW 16&amp;</li> <li>• Triple watch: TW 16&amp;</li> </ul>	13	Indicates the condition of the Bluetooth® wireless speaker microphone. This icon becomes blue after the pairing is finished.
5	Indicates highlight at CH16 (priority channel) or CH70	14	Indicates current time as follows. <ul style="list-style-type: none"> <li>• Universal time coordinated: UTC</li> <li>• Local time: LT</li> </ul>
6	Indicates the current region channel. ITU/ USA/ CAN (Canada) / IWW (Inland water way) / P0/P1/P2 (Private)	15	Indicates the source and quality of the ship's position. For details, see 9.4 (1.3).
7	Indicates the current channel.	16	Indicates CH70 watching continuously by the DSC watchkeeping receiver.
8	Indicates the first two digits when a four-digits channel is set.	17	Indicates that the currently selected channel is a duplex channel for communicating with coast stations.
9	Indicates the meter of receiving signal strength indicator (RSSI).	18	Indicates the channel letters (A or B) for the USA or Canada region channel mode.

(2) Buttons

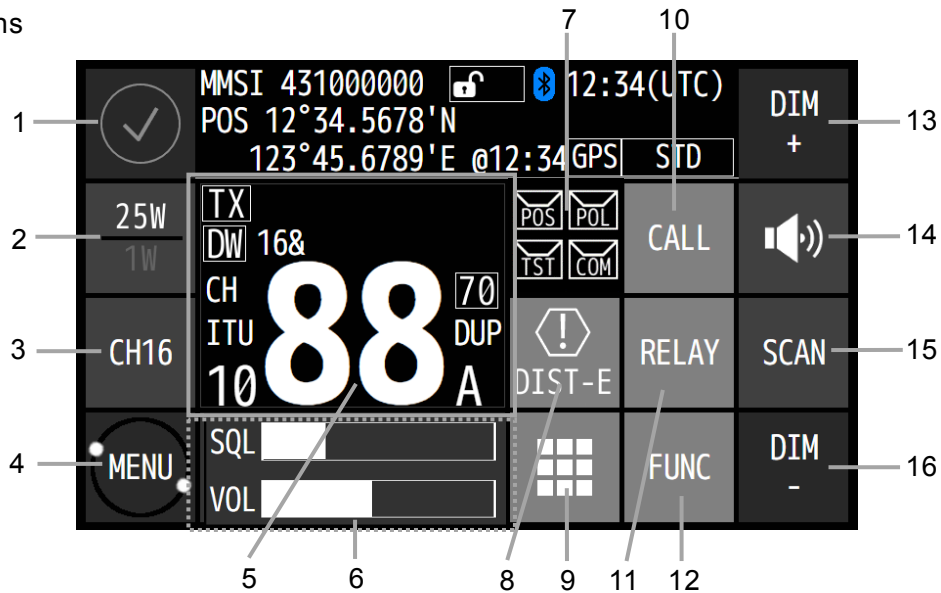





1	Indicates a BAM alert icon when a DSC call is received or any malfunction occurs (the above figure shows normal condition). Additionally, the BAM alert list is appeared by touching this button. (For more details, see 6.3 BAM alert indication.) Warning:  (Active-unacked)  (Silenced)  (Rectified-unacked) > (Active-acked)  (Active-responsibility transferred) Caution:  (Active)
2	Switches transmitting power between 25 W and 1 W. The showing value is changed each other, and is the current condition.
3	Sets the CH16 (priority channel) to the radiotelephone. While displaying OPE button, touching here obtains the access rights.
4	Indicates the menus screens. And also indicates the condition that the system is operating by the rotating freeze indicator.
5	Indicates the numeric key pad (input 0 to 9) for selecting channels.
6	Switches the S meter display on/off. The range of the level is as follows. SIG: -20~+50 (dBuV), SQL: 0~15, VOL: 0~15
7	Indicates the DSC auto acknowledgement conditions. • POS: Position request call                      • POL: Polling call • TST: Safety test call                              • COM: Communication request call During communicating events, this button becomes [CALL LIST] button to display the communication selection screen. (See the next page in detail.)
8	Indicates a menu for editing the distress messages.
9	Indicates the numeric key pad (input 0 to 9) for setting channels. (Ten-key icon button)
10	Indicates the menu for sending DSC calls. Furthermore, on the status display, this button is a shortcut button for routine individual calls.
11	Indicates the menu for sending distress relay calls.
12	Indicates the function button keypad for various functions.
13	Increases the dimmer level in 15 steps.
14	Turns speaker on or off. (During using the equalizer function, "EQ" is displayed.)
15	User key (Programmable favorite button) Register a desired and assignable menu (e.g. frequently using) or a special function. (Factory default setting: SCAN)
16	Decreases the dimmer level in 15 steps.

## Names and Functions

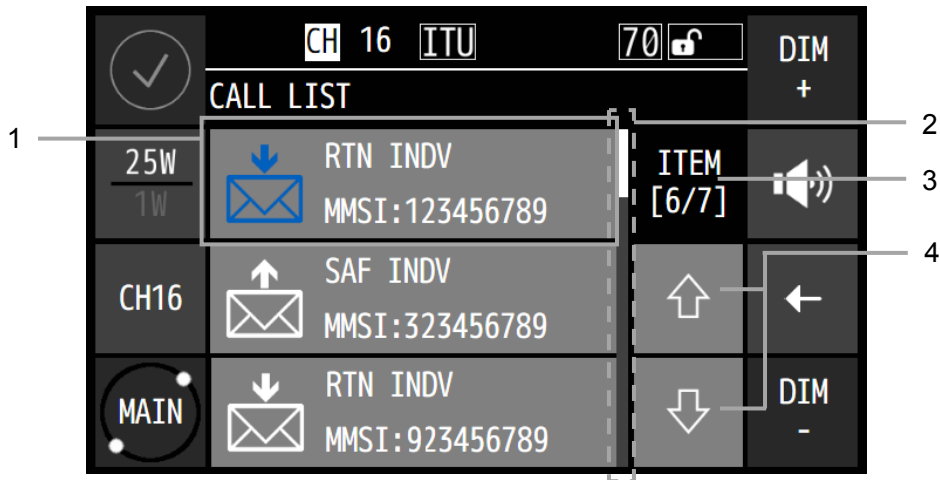
- CALL LIST screen

While there are active or on hold communication events, [CALL LIST] button is displayed on the status display. Touch [CALL LIST] button to display the communication event list.



1	<p>Selection button of DSC or non DSC call events</p> <ul style="list-style-type: none"> <li>- Icon: Sending DSC call..., Receiving DSC call..., Non DSC call...</li> <li>- Color: Active...Blue, On hold...White</li> <li>- Message type: Routine: RTN, Safety: SAF, Urgency: URG, Distress: DIST Distress relay: DST RLY</li> <li>- Format: Individual: INDV, Group: GRP, All ships: ALL (Note) Other than mentioned above, ACK or NACK is displayed.</li> <li>- Radio station: Called or calling MMSI number</li> </ul>
2	Shows the scroll position of the list.
3	Indicates the sum of the active and on hold events. (7 is the maximum number.)
4	Scrolls the list.



- Function button keypad

When touching [FUNC] button on the status display, the function button keypad is appeared as follows.

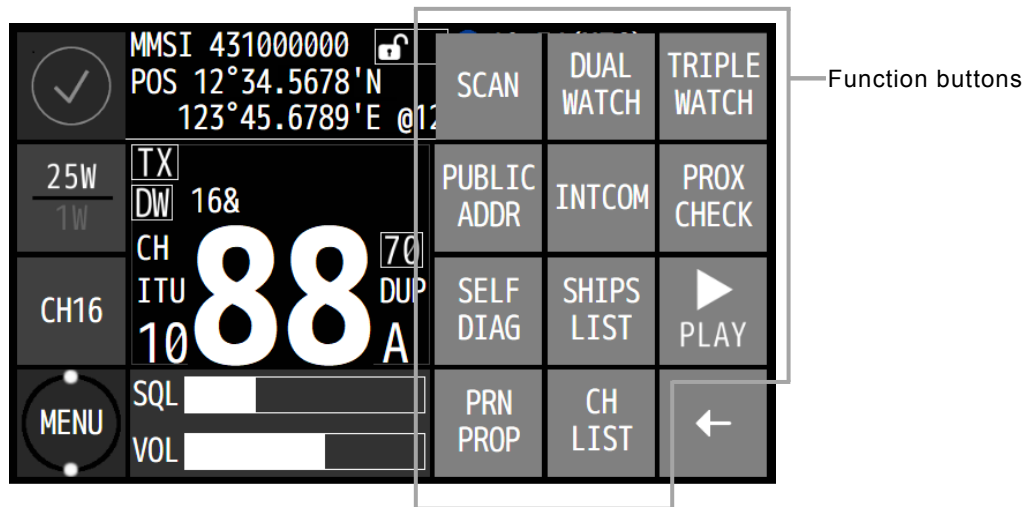

Additionally, the function buttons are programmable. Below are the factory default settings.

[SCAN]	Indicates the scan menu.
[DUAL WATCH]	Starts the dual watch.
[TRIPLE WATCH]	Starts the triple watch.
[PUBLIC ADDR]	Starts the public address mode.
[INTCOM]	Indicates the intercom menu.
[PROX CHECK]	Notification of registration vessel by AIS.
[SELF DIAG]	Indicates the self-diagnosis menu.
[SHIPS LIST]	Indicates other ship list by AIS.
[PLAY]	Starts playback the recorded data.
[PRN PROP]	Printer Properties.
[CH LIST]	Indicates the memory CH list.

**2.2.2 Operating screen**

(1) General

If the radiotelephone is operated by such as changing channels or opening/closing squelch condition on the status display, the communications event screen is appeared as follows.

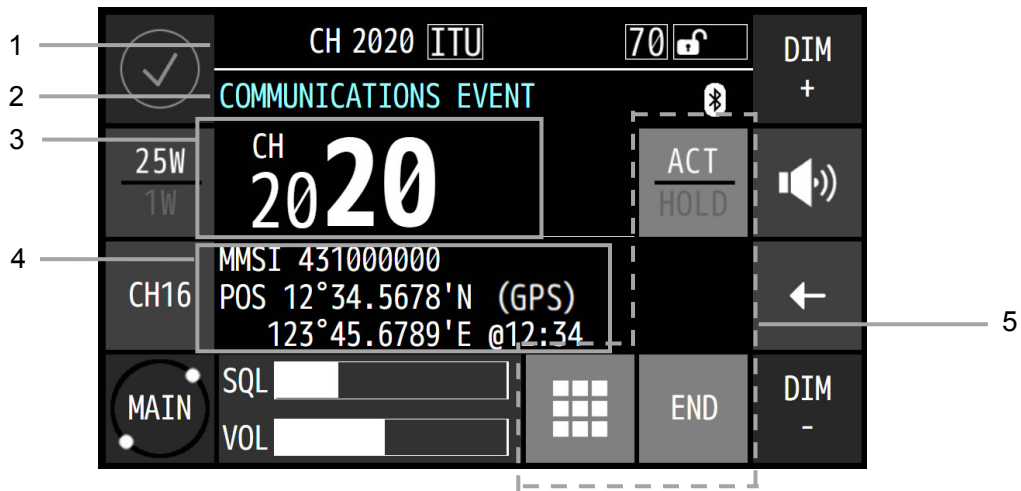

1	Indicates the standard information such as channel operation.
2	Indicates the communication event title.
3	Indicates the current channel.
4	Indicates the own ship's MMSI, the position and that time.
5	Indicates the ten-key icon button and the following handling menu buttons concerning the communications event.  [ACT/HOLD]: Switches the event state between Active and On hold. The showing description (ACK or HOLD) is changed each other, and is the current condition. [END]: Terminates the call.

## (2) Operating screen for DSC calls

When communicating using DSC calls, the screen shows as follows.

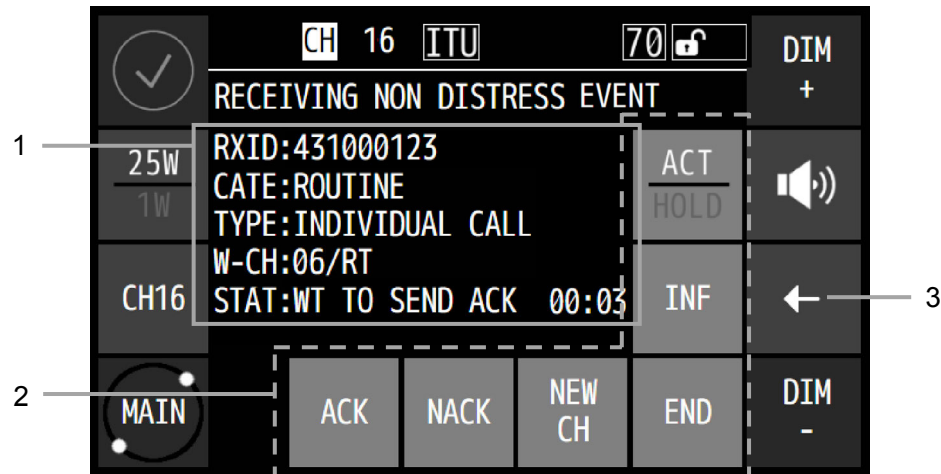

1	<p>Indicates the DSC message information.</p> <p>RXID or: TXID: Shows the received ID (sender MMSI) or transmitted ID (receiver MMSI). Additionally, the following special marks may be indicated on this line.</p> <ul style="list-style-type: none"> <li>- Any error (ECC error) character is detected. : <b>E</b></li> <li>- DSC event is started by a delayed acknowledgement. : <b>D</b></li> </ul> <p>CATE: Indicates the category of the DSC message. ROUTINE, SAFETY, URGENCY, or DISTRESS</p> <p>TYPE: Indicates the type of the call or the acknowledgement as follows. DISTRESS, GROUP, ALL SHIPS, INDIVIDUAL, DISTRESS RELAY, or NO INFORMATION</p> <p>W-CH: Indicates the work channel and the communication mode if used for the call.</p> <p>STAT: Indicates the progress state of the DSC call event and the elapsed time.</p>
2	<p>Indicates the handling menu buttons concerning the DSC call event.</p> <p>[ACK]: Accepts the call and sends the acknowledgement.</p> <p>[NACK]: Sends "unable to comply".</p> <p>[NEW CH]: Sends the acknowledgement with new work channel.</p> <p>[INF]: Displays the received message in detail.</p> <p>[ACT/HOLD]: Switches the event state between Active and On hold. The showing description (ACK or HOLD) is changed each other, and is the current condition.</p> <p>[END]: Terminates the call.</p>
3	<p>Touching this button displays the previous screen.</p>

**Note**

- While there is an active communication event, the DSC auto ACK function is disabled to avoid disruption of the on-going communication.
- When sending the "able to comply" acknowledgement against the received message requesting the radiotelephone communication, lifting the handset is also available instead of touching the ACK button.
- When touching the NEW CH or NACK button, the dedicated popup screen is appeared.
- When sending an acknowledgement automatically to the receiving calls such as position request, safety test, polling, or the call requesting communication with an invalid channel, the above screen is shown and starts sending automatically. After finishing it, that screen is closed automatically.
- If the AUTO CH CHG is setting to OFF in the DSC operation menu, when pressing the [STOP] button, the popup is displayed on the screen. In this case, select either one handling menu for the [ACCEPT] or [IGNORE]. For detail, see 5.5.7.

**2.2.3 Menu screen**

(1) Menu screen

When touching [MENU] button on the status display, the main menu is appeared.

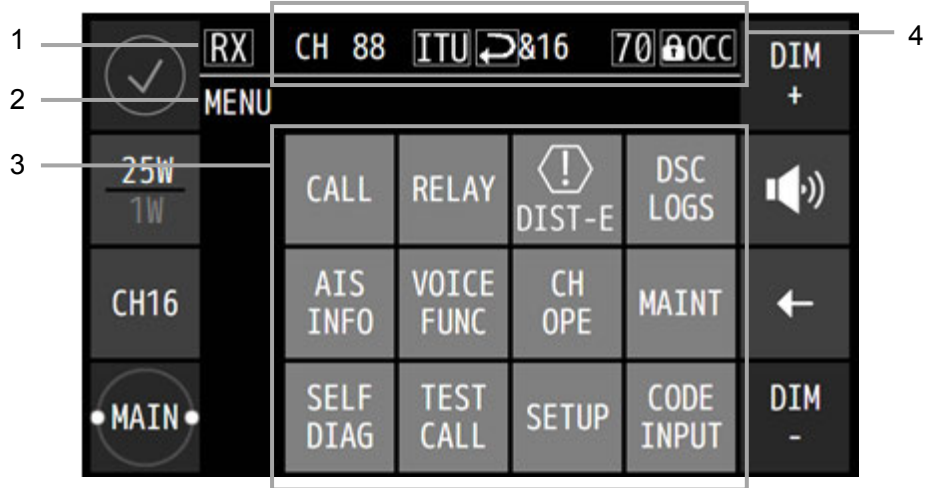

1	Indicates if opened the squelch while performing one of the VOICE FUNCTION menus. Additionally, <b>TX</b> appears while transmitting.
2	Indicates the current menu name.
3	Indicates the menu buttons.
4	Indicates the current channel and that region, scan condition, the state of the CH70 watching, and access rights.

(2) Button operations

The following buttons do the same operations in all the menu screens.

(This explanation uses an example of manually setting the date and time.)

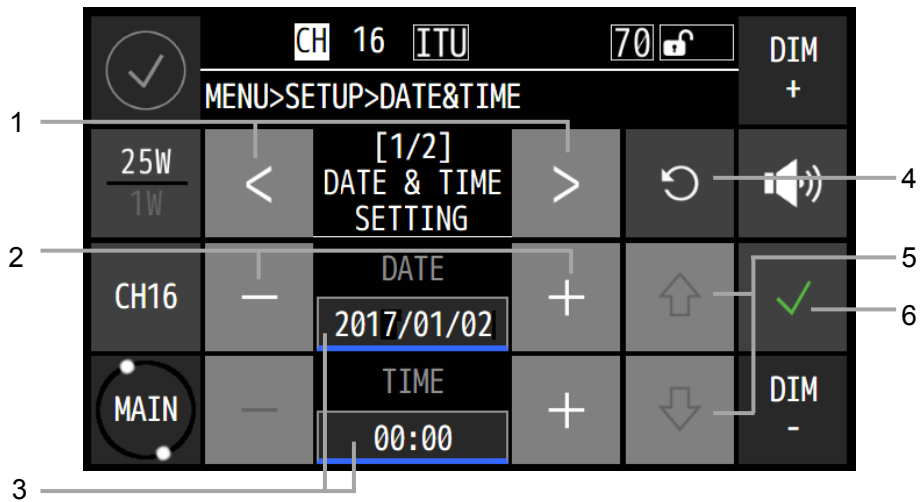

1	Changes the menu pages.
2	Increases or decreases the value or changes selection item.
3	Changes to the text input screen when the blue underline is indicated.
4	Cancels the previous operation and returns to the previous status. (UNDO button)
5	Scrolls the setting item list.
6	Saves the new settings or changed data. However if there is no settings or changes on the menu, [←] button for returning to the previous screen is displayed.

## Names and Functions

### (3) Text input operations

For text input menu, the specific keypads for alphabet, numbers or symbols are available to input them. The buttons and the functions are shown below.

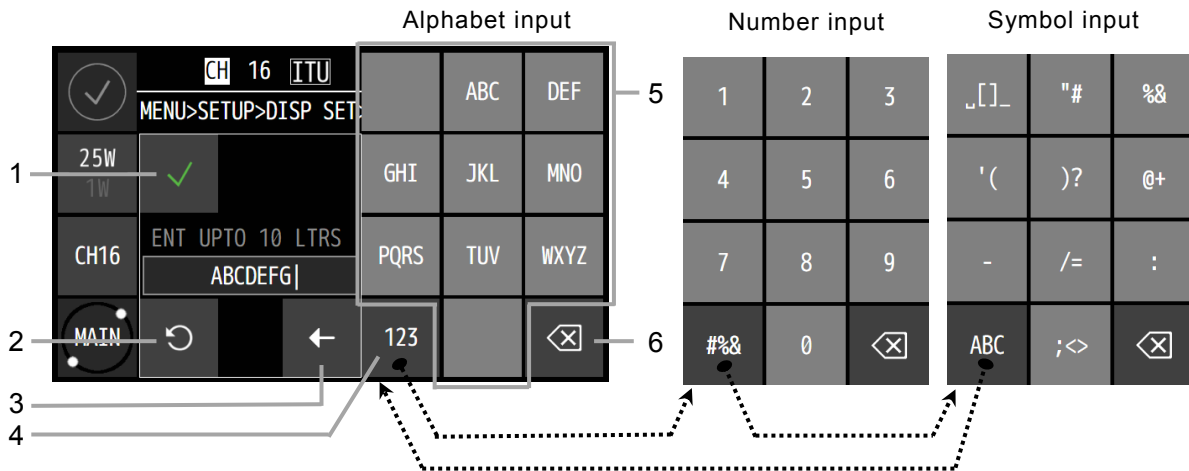

1	Saves the new settings or changed data.
2	Cancels the previous operation and returns to the previous status. (UNDO button)
3	Returns to the previous screen.
4	Changes the keypad as follows if three kinds of characters are allowed to input. <ul style="list-style-type: none"> <li>▪ [123]: numbers</li> <li>▪ [#%&amp;]: symbols</li> <li>▪ [ABC]: alphabet (uppercase or lowercase)</li> </ul>
5	Select characters by single or multiple touching. The input character is entered by leaving one second or inputting another character.
6	Deletes one character. (Back space button)

(4) List operations

On the list screen, touch the target item to select.

(Below is an example of operations for COAST on the CALL LIST.)

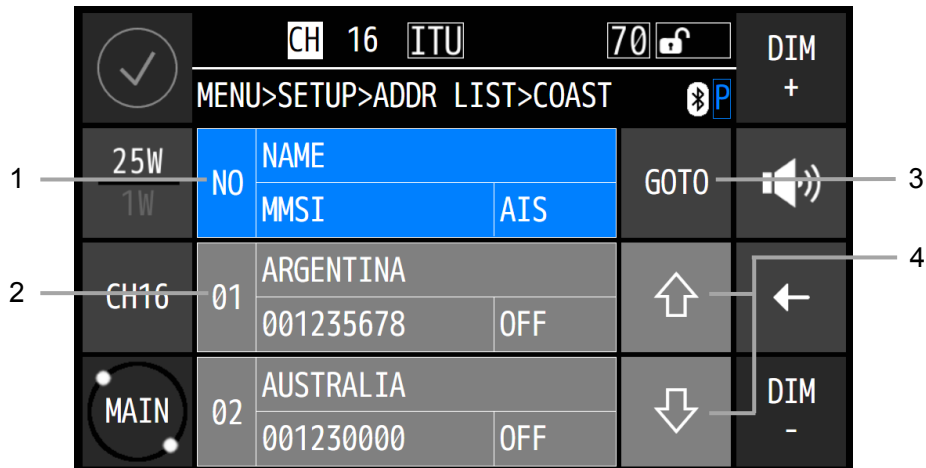

1	Becomes blue to show printable if the P is indicated on the right edge of the title line.
2	Selects from the list by touching the target item.
3	Indicates the input dialog box to jump to that number.
4	Scrolls the list.

**Note**

- To make print function available, set the menu PRN PROP>STATE to ON.
- About the printable menus, refer to the menu tree in the "4.1 Overview of operations of the equipment".

■ Printout procedure

Touch the above-mentioned blue button to display the popup screen as shown at right.

- Touch OK button to start printing the list.
- Touch CANCEL to cancel printing.

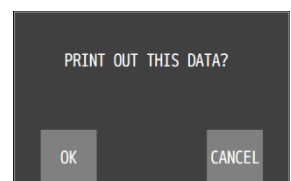

■ Printout procedure with selection

In the case of the menu displaying such the screen as shown at right, the print item can be selected if SELECT is set at the MODE on the menu.

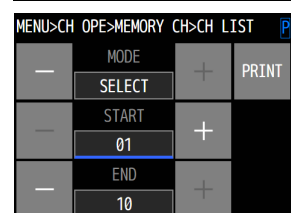
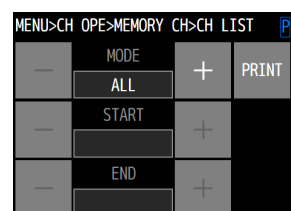

### 3. INSTALLATION



## CAUTION



Leave installation of this equipment to our service center or agents. Special knowledge on selecting the place where the antenna is to be mounted and setting the ID number (MMSI) assigned to the ship is required in addition to mounting the equipment.



## 4. OPERATION

This chapter describes basic operations of the equipment, radiotelephone communications, procedures to use DSC to call another station, and other functions.



### CAUTION



Do not use a sharp object for touch panel operation.  
Otherwise, the screen may be damaged.

### 4.1 Operation overview

- This equipment is mainly operated by the control panel or the handset of the JHS-800S marine VHF radiotelephone or NCM-980 controller (option).
- Basically all the functions can be operated by using the buttons on the touchscreen, except for the knobs and buttons on the panel. See the menu tree on the next page.
- When one or more controller is connected, basically only one control panel of the main unit (JHS-800S) or controller (NCM-980) having the access rights can be operated, except for the distress alert by the **DISTRESS** button, changing audio volume, and changing display conditions. (Unless otherwise mentioned, the instructions below are for the control panel with the access right.)
- The **DISTRESS** button is always available regardless of the access right (this button has the highest priority).
- To obtain the access right at the control panel having no access right, touch the OPE button or lift the handset from the cradle, unless another control panel is in the state of such as opening the menu or PTT ON. However, the higher priority control panel can obtain the access right unless the lower priority one is in the state of PTT ON.
- Replacing the handset on-hook returns the channel to CH16 (factory default setting). Also, on-hook detection can be disabled by setting the handset menu.
- For menu operations, touch the [MENU] button to open the main menu and touch the target function menu buttons to select items or input data.
- The function buttons appeared by the [FUNC] button and the user key ([FAVORITE] button) on the right edge of the screen are programmable and the frequent use functions can be registered on them in advance.
- Touching the [MAIN] button in any menu moves the display to the status display.
- If menu screens are left without operating for a period set by the menu, the screens are closed automatically and return to the status display.
- The popup screens are opened adequately and operations by the dialog boxes are available.
- In the menu tree on the next page, the menu items indicated "OK" on the Printable column can be printed out from the connected printer by touching the blue button on that menu screen.

## Operation

### Menu tree

Menu	Hierarchical Menu 1	Hierarchical Menu 2	Print func	Description	
CALL				DSC non-distress call	
RELAY				DSC drobose call	
DIST-E				Editing distress message	
DSC LOGS	RX DIST		✓	Received distress call log	
	RX OTHERS		✓	Received non-distress call log	
	TX CALLS		✓	Transmitted call log	
AIS INFO (*)	SHIPS LIST		✓	Other ships list	
	PROX CHECK			Registered ships notice	
VOICE FUNC	PLAY-BACK			Playback received voice msg	
	PUBLIC ADDR			PA using external loudspeaker	
	INTCOM			Starting intercom	
CH OPE	SCAN	ALL CH		All channel scan	
		MEMORY CH		Memory channel scan	
		SELECT CH		Selected channel scan	
	DUAL WATCH			Watching CH16 & 1 channel	
	TRIPLE WATCH			Watching CH16 & 2 channels	
	MEMORY CH	CH LIST	✓	Setting CH from memory CH list	
		CH EDIT		Editing memory CH list	
	PRIV CH		✓	Private channel	
	WX CH		✓	Weather channel	
	REGION	ITU			ITU channel mode
		USA			USA channel mode
		CAN			Canada channel mode
		IWW			Inland waterway mode
	CH SQL SET			Preset squelch setting	
BCF START (**)			Block channel function for river		
MAINT	ALERT LIST	ALERT HIST	✓	Alert information	
	SYSTEM INFO		✓	System information	
	S/W VER		✓	Software version	
	DSC AF CHECK			DSC signal inspection	
	CERT MARK			Displaying certification mark	
SELF DIAG	TRX		✓	RF CKT self diagnosis	
	OWN CTRL		✓	Control CKT self diagnosis	
	DSC LOOP		✓	DSC loop self diagnosis	
	TRX LOG		✓	RF CKT self diagnosis log	
	CTRL LOG		✓	Control CKT self diagnosis log	
TEST CALL				DSC safety test call	
SETUP	DATE&TIME			Setting date and time	
	POS SET	POS/TIME		Setting position, time and indicator	
		POS SOURCE		Setting priority for position source	
	DISP SET	LCD ADJ			LCD adjustment
		SOUND			Setting related to sound
		KEY ASSIGN			Programmable key assignment
		UNIT NAME			Unit name registration
		MENU SHTDN			Setting menu shutdown timer
		HANDSET			Setting hook and sidetone
		CH AREA			10-key assignment on CH area
		S METER			Setting RF strength meter use
		CTLR START		✓	PWR ON mode (controller only)
		BT SET	BT FUNC		
	BT PAIR			✓	Pairing Bluetooth SPMIC
	ADDR LIST	COAST		✓	Coast station list registration
		SHIP		✓	Ship station list registration
		GROUP		✓	Calling group list registration
		PSTN		✓	PSTN number list registration
	DSC OPE	AUTO ACK		✓	Automatic acknowledgement
		RX SOUND		✓	Safety/Routine alert sound
		MDCL USE		✓	Medical use for urgency call
		NEUT USE		✓	Neutral use for urgency call
		EXP MMSI		✓	Expanded MMSI
		GROUP ID		✓	Own ship's registration
		INACTV T/O		✓	Inactivity timer set
		AUTO CH CHG			Automatic channel change
	AIS FUNC (*)			Setting AIS use	
PRN PROP			✓	Printer property set	
BLOCK CH (**)			✓	Waypoints registration	
CODE INPUT				(for maintenance)	

\* Invisible without connecting AIS.

\*\* Invisible if the BCF setting in the field maintenance menu is invalid.

## 4.2 Basic communication procedure

The following describes basic radio communication procedures.

### 4.2.1 Turning ON the power



# CAUTION



Do NOT turn off the power of the equipment when at sea because the SOLAS Convention requires keeping CH16 watch at all times.

#### ■ Procedure ■

1. Press the [PWR] button for at least 1 second.

An operational check is practiced at the main unit and optional controllers (The screen at right is of the main unit). When finished normally, the status display appears and the starts receiving at the appeared channel on the screen.

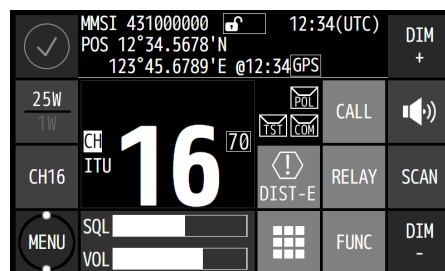

- Note**
- When the external power is supplied to the main unit, the main unit is automatically turned on.
  - If detected errors during the memory check, the following message is appeared. Then inform JRC or our agent of the error content.

Message	Content
DETECTED MEMORY ERROR! SO PARTIALLY RESET THE MEMORY AREA OF MARINE VHF.	A part of memory was reset because a memory error was detected on the main unit.
DETECTED MEMORY ERROR! SO PARTIALLY RESET THE MEMORY AREA OF VHF CONTROLLER.	A part of memory was reset because a memory error was detected on the VHF controller.
DETECTED THIS CONTROLLER'S UNIT ID SETTING ERROR! SO SET THE UNIT ID AFTER RESTARTING AS THE MAINTENANCE MODE	A unit ID error was detected in the controller. Please set correct unit ID.
DETECTED INTERNAL FAILURE! SO REQUIRED TO CHECK AND REPAIR THE UNIT OR CONNECTION.	An error was detected inside the main unit. Please check and repair internal units and connections.
DETECTED MARINE VHF LOST! SO REQUIRED INITIAL SET AFTER RESTARTING AS THE MAINTENANCE MODE.	The controller can't communicate with the main unit. Perform initial setting such as communication speed.
DETECTED MMSI LOST! SO CONCERNED FUNCTIONS (DSC/ATIS) NO LONGER AVAILABLE NOW.	The MMSI of the ship has not been entered or has been lost. DSC and ATIS functions are disabled.

**4.2.2 Turning OFF the power**

**■ Procedure ■**

**1.** Press the [PWR] button for at least 1 second.

In this case, the process varies, as shown below, according to the main unit and the status of the connected controllers.

(1) In case of the main unit, the popup screen on the right appears. Select one of the following.

- [ALLOFF]: Turns off the power to the main unit and all controllers.
- [CANCEL]: Returns to the previous screen.

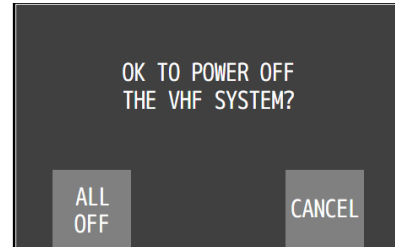

(2) In case of the controller being have the access rights, the popup screen on the right appears. Select one of the following.

- [OFF]: Turns off the power to the controller.
- [ALL OFF]: Turns off the power to the main unit and all controllers.
- [CANCEL]: Returns to the previous screen.

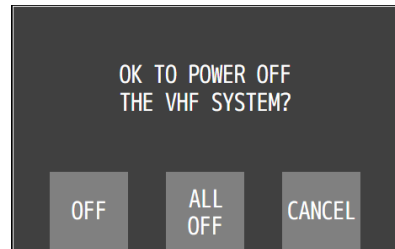

(3) In case of the controller not being have the access rights, the popup screen on the right appears. Select one of the following.

- [OFF]: Turns off the power to the controller.
- [CANCEL]: Returns to the previous screen.

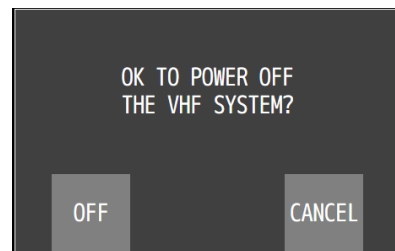

**Note** Pressing the [PWR] button for 8 seconds or more turns off the power forcibly.

**4.2.3 Communicating with the radiotelephone**

The VHF radiotelephone is operated by using the handset or the wireless speaker microphone.

■ **Procedure** ■

1. When operating on a control panel having no access right (OCC is displayed), touch the OPE button to obtain the access right or lift the handset from the cradle.

Unless otherwise the other control panel is in use, the OCC is disappeared and the control panel becomes available.

**Note** When the hook-switch setting is invalid, the access right cannot be obtained by lifting the handset from the cradle.

2. Adjust the volume on the loudspeaker by turning the volume control.

When receiving no signal, make a noise as a guide by turning the squelch control counterclockwise until opened.

3. Turn the squelch control to an appropriate position.

Normally, the squelch control would be adjusted to where rotated the squelch control clockwise one additional tick from the squelch closing position.

4. Lift the handset from the cradle.

5. Press the PTT key to talk.

The **TX** mark is appeared on the screen to show the equipment is transmitting. Releasing the PTT key returns to the receiving condition.

6. If necessary, change the channel using the numeric keypad or UP/DOWN button.

To indicate the numeric keypad, touch the channel display area or the ten-key icon button on the status display. When setting a new channel using the numeric keypad, incase of CH18, input [1] and then [8] continuously.

7. When finished the communication, return the handset to the cradle.

**Note** Replacing the handset back on-hook returns the channel to CH16. However, if the hook-switch setting is invalid, the channel is not returned by replacing the handset to the cradle.

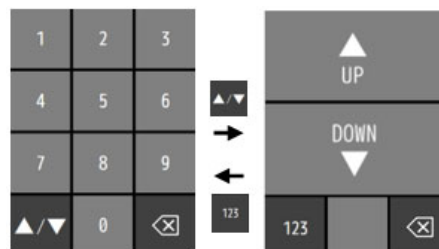
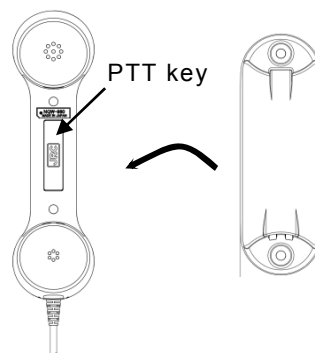
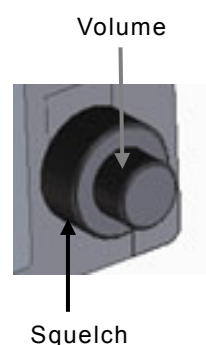
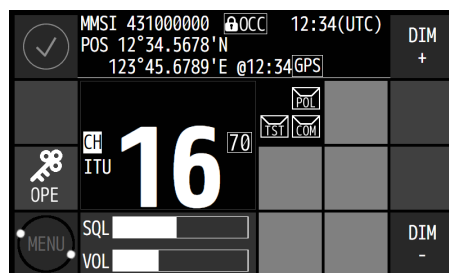

## ■ Changing the channel ■

### (1) Setting a 2-digits channel (Incase of the CH18)

---

1. On the status display or operations screen, touch the channel display area or the ten-key icon button to indicate the numeric keypad.
2. Touch the [1] button.  
"1" is appeared. Then if left for more than 1 second, the hyphen is appeared and starts flashing as shown at right.
3. Touch the [8] button.  
Setting of the CH18 is finished.

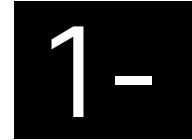

### (2) Setting a 2-digits channel with a letter A/B (Incase of the USA CH20A)

---

1. On the status display or operations screen of the USA region channel, touch the channel display area or the ten-key icon button to indicate the numeric keypad.
2. Touch the [2] button.  
"2" is appeared. Then if left for more than 2 seconds, the hyphen is appeared and starts flashing as shown at right.
3. Touch the [0] button.  
CH20 is set, and the [A] and [B] buttons appear.
4. Touch the [A] button.  
Letter A is appeared and setting of the CH20A is finished.

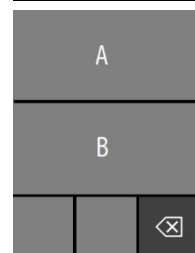

## (3) Setting a 4-digits channel (Incase of the CH1020)

**1.** On the status display or operations screen, touch the channel display area or the ten-key icon button to indicate the numeric keypad.

**2.** Touch the [1] button.  
“1” is appeared. Then if left for more than 1 second, the hyphen is appeared and starts flashing as shown at right.



**3.** Touch the [0] button.  
CH10 is set, first.



**4.** Touch the [2] button within one second.  
The 4-digits display form at right is appeared. Then if left for more than 1 second, the hyphen is appeared and starts flashing as shown at right.



**5.** Touch the [0] button.  
Setting of the CH1020 is finished.

**Note**

When the hyphen is flashing, if left without inputting a figure for 2 seconds, the channel returns to the previous value. Additionally in the above example, if the 3 digits are input and the hyphen is flashing at the ones place digit for 2 seconds, then the channel returns to the CH10 which is temporarily set in this procedure.

### ■ Making a radiotelephone call ■

1. Select CH16 or other agreed channel.
2. Lift the handset from the cradle.
3. Press the PTT key, and make a call as described below.
  - Say the calling station name ... Repeat 3 times.
  - "this is"
  - Say own ship name ... Repeat 3 times.
  - "over"
4. Release the PTT key to listen.
5. When answered and agree on a working channel, change to that channel.
6. After checking that no station uses the working channel, begin conversation.

- Note**
- When transmitting from own station, always press the PTT key while talking.
  - On a simplex channel, always say "over" just before releasing the PTT key.
  - Always say "out" when terminating communications.

### ■ Receiving a call on CH16 ■

1. Lift the handset from the cradle.
2. Press the PTT key, and respond to the call as described below.
  - Say the caller station name.
  - "this is"
  - Say own ship name.
3. Propose a channel other than 16 as described below.
  - "channel"
  - Working channel number
4. Allow the caller station to send.
  - "over"
5. Release the PTT key, wait a moment, and then switch to the proposed working channel.
6. After checking that no station uses the working channel, begin conversation.

- Note**
- When transmitting from own station, always press the PTT key while talking.
  - On a simplex channel, always say "over" just before releasing the PTT key.
  - Always say "out" when terminating communications.



**4.2.4 Receiving with scanning**

Scanning function enables to watch multiple channels (additional channels) with the priority channel (CH16). If found receiving signal on the additional channels, the dwell time on that channel will be longer, but continued to watch the CH16 alternatively. The scan mode can be selected from the following modes.

- All CH scan Mode: Scans all channels in the current channel mode.
- Memory CH scan Mode: Scans all memory channels.
- Select CH scan Mode: Scans the specified range of channels.

**■ Procedure ■**

**1.** From the main menu, touch the [CH OPE] → [SCAN] buttons.

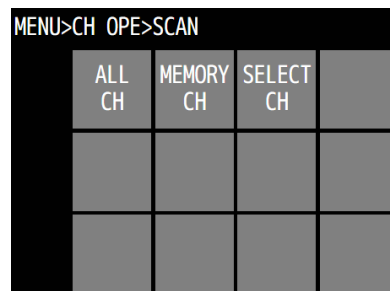

**2.** Touch the menu button of the scan mode to select.

- In case of the [ALL CH] button or the [MEMORY CH] button, the scan starts immediately.
- In case of the [SELECT CH] button, the screen at right appears and set the channel range as follows.

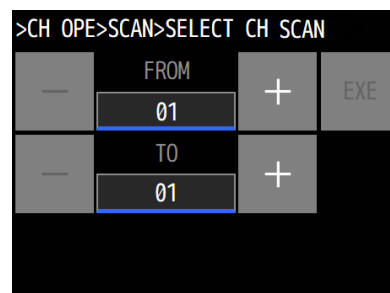

- 1) Input the start channel (FROM:) and the stop channel (TO:).
- 2) Touch the [EXE] button to start scanning as shown at right.

**Note**

- Disabled to scan when the channel region is Inland Waterways (IWW).
- CH70 is skipped, even if contained in the scanning range.

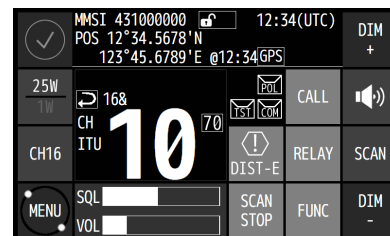

**3.** Touch the [SCAN STOP] button to stop scanning.

- After terminated, the radiotelephone is set on the last stopped channel. (The example at right shows when stopped on CH12.)
- Scanning is also terminated when off-hook or PTT ON is detected.

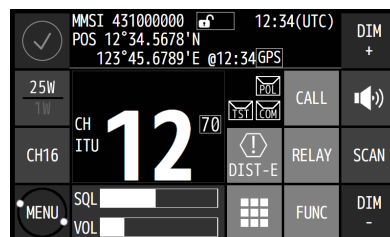

**Note**

- While scanning, the radiotelephone scans CH16 and the additional channels alternatively in a cycle of 0.14/0.86 seconds.
- If the squelch is opened on the CH16, paused scanning and continues to watch on the CH16. If squelch is closed again, the scanning will resume 2 seconds later.

## Operation

- If the squelch is opened on an additional channel, remains on that channel and CH16 alternatively (in a cycle of 0.14/1.86 seconds). If squelch is then continuously closed (until the end of the scan cycle), the scanning will resume. Furthermore, added to the additional channel, if the squelch is also opened on the CH16, paused scanning and continues to watch on the CH16 as described above.

### 4.2.5 Receiving with dual watch

Dual watch function enables to watch an additional channel with the priority channel (CH16). If found receiving signal on the additional channel, the dwell time on that channel will be longer, but continued to watch the CH16 alternatively.

#### ■ Procedure ■

1. From the main menu, touch the [CH OPE] → [DUAL WATCH] buttons and select the channel for dual watch.

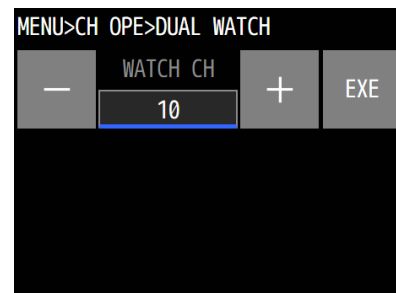

2. Touch the [EXE] button.

The dual watch starts immediately.  
The example at right shows the case of CH10 selected.

#### Note

Disabled the dual watch either when the channel region is Inland waterways (IWW) or when CH70 has been selected.

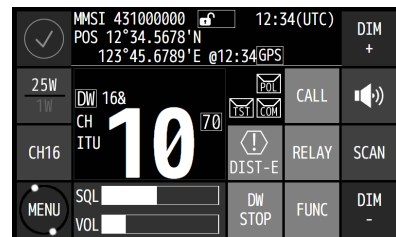

3. To terminate the dual watch, touch the [DW STOP] button.

- After terminated, the radiotelephone is set on the additional channel. (The example at right shows when stopped on CH10.)
- The dual watch is also terminated when off-hook or PTT ON is detected or a channel is set in the DSC transmission menu.

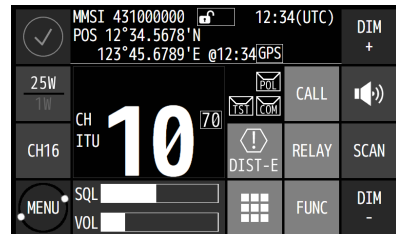

#### Note

- During the dual watch, the radiotelephone watches CH16 and the additional channel alternatively in a cycle of 0.14/0.86 seconds.
- If the squelch is opened on the CH16, pauses the dual watch and continues to watch on the CH16. If squelch is closed again, the dual watch will resume 2 seconds later.
- If the squelch is opened on the additional channel, the dwell time on that channel will be longer, but continues to watch the CH16 alternatively (in a cycle of 0.14/1.86 seconds). If squelch is then continuously closed (until the end of the dwell time), the dual watch will resume. Furthermore, added to the additional channel, if the squelch is also opened on the CH16, pauses the dual watch and continues to watch on the CH16 as described above.

**4.2.6 Receiving on triple watch**

With triple watch, channel 16 and two other channels are monitored.

**■ Procedure ■**

- From the main menu, touch the [CH OPE] → [TRIPLE WATCH] buttons and select two channels for triple watch.

CH10 and CH22 are selected in the example at right.

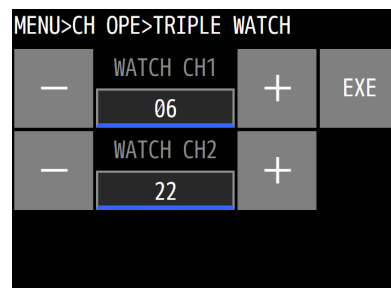

- From the main menu, touch the [CH OPE] → [TRIPLE WATCH] buttons.

The triple watch starts immediately.

**Note** Disabled the triple watch either when the channel region is Inland waterways (IWW) or when CH70 has been selected.

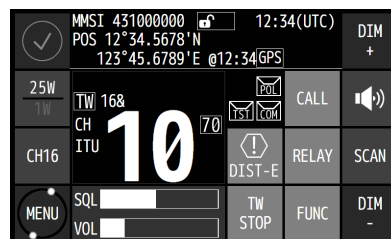

- To terminate the triple watch, touch the [TW STOP] button.

- The channels for triple watch are stopped and the transceiver starts receiving. (The example at right shows when triple watch is stopped on channel 10.)
- The triple watch is also terminated when off-hook or PTT ON is detected or a channel is set in the DSC transmission menu.

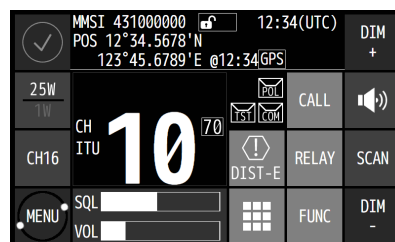

- Note**
- During the triple watch, the radiotelephone watches channel 16 and two other channels and the channels cycle in order with a dwell time of 0.14/0.43/0.43 seconds.
  - If the squelch is opened on channel 16, the triple watch pauses and the watch continues on channel 16. If squelch is closed again, the dual watch resumes 2 seconds later.
  - If a signal is detected and the squelch is opened on one of the other two channels in the triple watch, the dwell time changes to a cycle of 0.14/1.86 seconds and the watch continues (other channels are not scanned and watched). If squelch then remains continuously closed (until the end of the triple watch cycle time), the triple watch resumes as normal. Furthermore, if in this state a signal is detected on channel 16, then channel 16 is watched continuously as described above.

## 4.2.7 Using memory channels

Memory channels are the original channel list. The desired channels (e.g. frequently using channel) can be registered and used for easy access.

### (1) Registering memory channels

#### ■ Procedure ■

- From the main menu, touch the [CH OPE] → [MEMORY CH] → [CH EDIT] buttons.

For example, the screen at right is displayed.

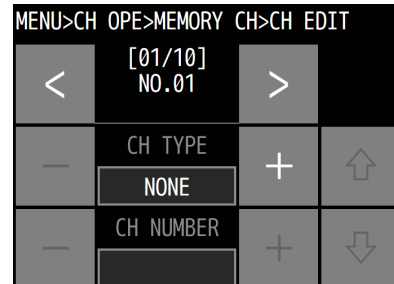

- Select the memory number from 1 to 10 to register.

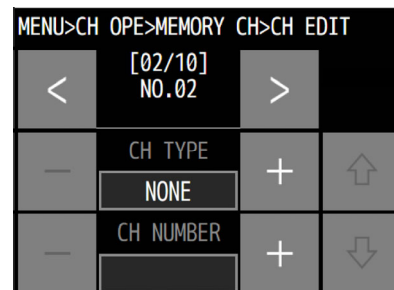

- Select the input data on the CH TYPE and CH NUMBER respectively.

The CH TYPE is changed such as NONE → ITU → USA → CAN → IWW → PRIVATE → WEATHER.

- ITU/USA/CAN/IWW: Region channel
- PRIVATE: Private channels
- WEATHER: Weather channel

Repeat the above step 2 and 3 on the every memory channel to be registered.

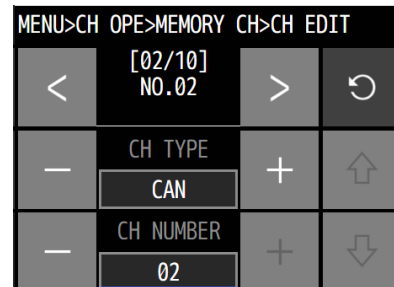

- To finish registering the memory channels, touch the [✓] button to save.

## (2) Communicating on a memory channel

Memory channels is available e.g. when setting a working channel for subsequent communication after initial contact on CH16.

### ■ Procedure ■

1. From the main menu, touch the [CH OPE] → [MEMORY CH] → [CH LIST] buttons.

MENU>CH OPE>MEMORY CH>CH LIST		
NO	CH TYPE CH NUMBER	GOTO
01	PRIVATE CH 002	↑
02	CAN CH 60	↓

2. Scroll the memory channel list, if required, then touch the channel to set.

If the memory channel number 01 on the screen above is selected, the CH P002 is set.

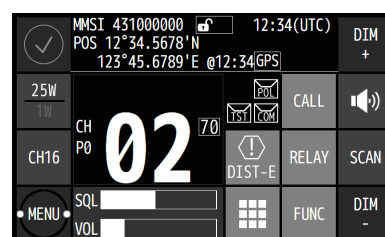

### 4.2.8 Communicating on a private channel

Private channels for assigned frequencies of fishing ship or other specially assigned frequencies are registered at the installation of equipment. Up to 200 channels are available for radiotelephone communications. (If required to add channels after installation, please contact JRC or our agent.)

### ■ Procedure ■

1. From the main menu, touch the [CH OPE] → [PRIV CH] buttons.

MENU>CH OPE>PRIV CH			
NO	TX FREQ/RX FREQ(MHZ)	GOTO	
	TYPE	TX PWR	SCRAMBLE
001	155.0000	155.0000	
	SIMP	25W	OFF
002	155.0000	155.0000	
	SIMP	25W	OFF

2. Scroll the private channel list, if required, and then touch the channel to set.

If the channel 200 is selected, the status display appears as shown at right.

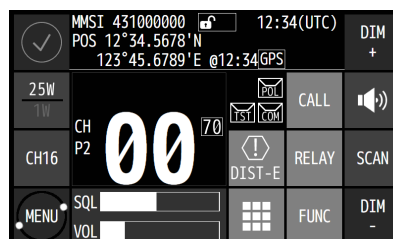

### 4.2.9 Receiving a weather channel

Weather channels are available to receive weather information on the North American coast.

#### ■ Procedure ■

1. From the main menu, touch the [CH OPE] → [WX CH] buttons.

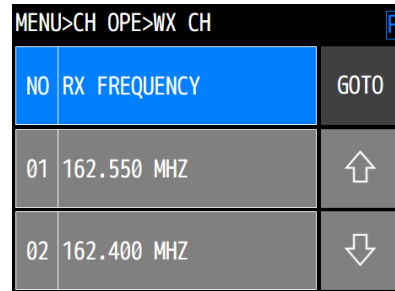

2. Scroll the weather channel list, if required, then touch the channel to set.

If the channel 08 is selected, the status display appears as shown at right.

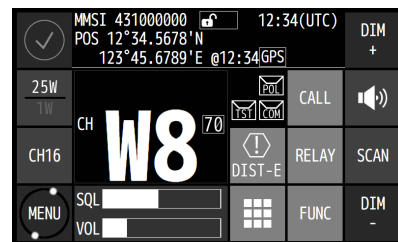

**Note** Disabled to send on weather channels.

### 4.2.10 Changing the channel region

This menu sets the channel region to ITU, USA, Canada (CAN), or Inland Waterway (IWW).

#### ■ Procedure ■

1. From the main menu, touch the [CH OPE] → [REGION] buttons.

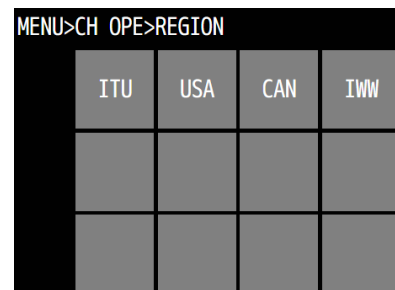

2. Touch the target region button to select.

When selected the USA channel, the screen becomes as shown at right.

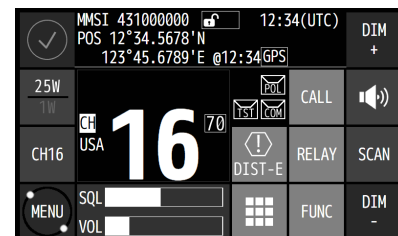

**Note** When set to the Inland Waterway (IWW), changed a few functions as follows.

- Enabled the ATIS function automatically and sends the ATIS code over the voice channel when releasing the PTT key. Also, if pressed the PTT key continuously, sends the ATIS code every five minutes automatically.
- The scan, dual watch, and triple watch functions are prohibited.
- When operating the DSC menus, a popup screen is displayed to notice that the DSC usage is not allowed on Inland Waterways.

#### 4.2.11 Squelch settings of each channel (preset squelch)

The adjusted squelch value can be stored with respect to each channel as a preset squelch. The handling of the preset squelch is as follows.

- If stored the squelch value, the preset squelch is always set just after the channel selection.
- While the preset squelch has been set, "PSQL" is indicated on the status display.
- If turned the SQL control after setting the preset channel, the preset value is canceled immediately and the SQL control is available.
- The preset squelch value can be cleared with respect to each channel or each channel region.

#### ■ Procedure ■

1. After setting the target channel for presetting as the TRX channel of the marine VHF radio, from the main menu, touch the [CH OPE] → [CH SQL SET] buttons.

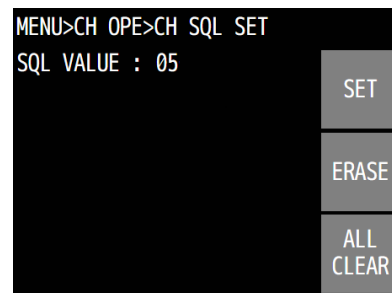

2. Turn the SQL control to the appropriate position.

The SQL VALUE as shown at right is changed according to the position of the knob.

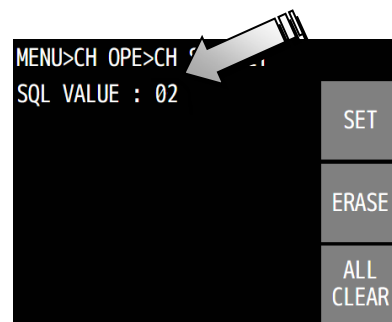

3. Touch the [SET] button to complete the preset for the squelch.

#### Note

- To delete a preset squelch, set that channel and then touch the [ERASE] button in the CH SQL SET menu above.
- To clear the preset squelch values for all the channels in a set region, touch the [ALL CLEAR] button in the CH SQL SET menu above.

## 4.3 Basic DSC operations

When calling stations, the DSC is also available for a routine/ safety/ urgency or a distress call in addition to the calling by radiotelephone described above. This section describes the procedures for basic DSC routine calls and for the AIS-linked DSC calls.

### 4.3.1 Routine calls to an individual station

A DSC routine call to the station to be called is initiated as follows.

#### ■ Procedure ■

1. On the status display, touch the [CALL] button.
  - The address list of the radio stations registered before is appeared as shown at right (alphabetically sorted). Then touch the station to select the address for the routine individual call.
  - If the target radio station is not registered in the address list, touch the [←] button to input the address (MMSI) manually.
  - If the radio station list is not registered, the screen at lower right is displayed. Then input the address (MMSI) manually.

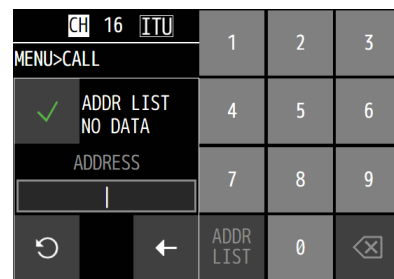
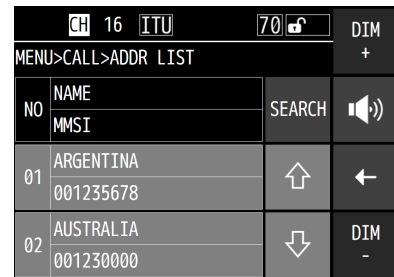

- Note**
- The above-mentioned [CALL] button on the status display is just the shortcut based on the [CALL] button in the main menu so that the routine individual call can be sent easily.
  - The station list can be registered on the ADDR LIST menu (MENU> SETUP).

2. After inputting the address, touch the [CALL] button to make a call.
  - Incase of the call to the ship station, the Work CH is selected automatically.
  - Incase of the call to the coast station, the working channel is selected by the coast station and is not selectable from the ship station.

- Note**
- To check the details of the message, touch the [PREV] button to open a screen as shown at lower right.

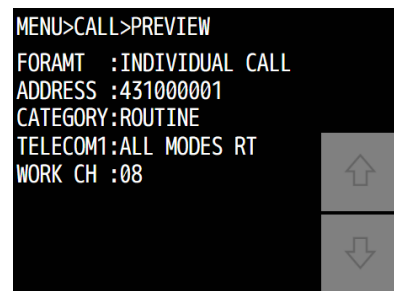
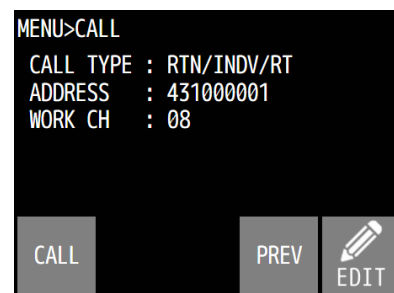



3. The operating display is appeared and initiates the DSC call

After checking the free channel condition, the equipment sends the message and then starts waiting for the acknowledgement.

**Note** While waiting for the acknowledgement, the following handling menus are available.

- RTRY: Resends the message.
- INF: Indicates the message contents.
- HLD: Makes the event on hold.
- END: Terminates the event.

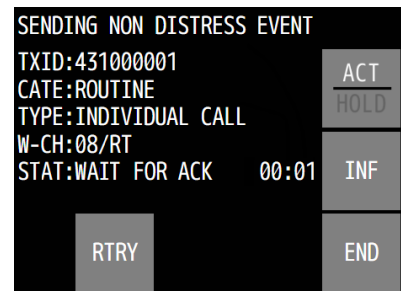
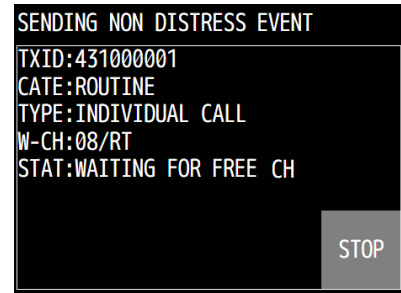

4. When the acknowledgement is received, the RX DSC mark flashes and the alert sounds.

- To silence the alert, touch the [STOP] button.
- The working channel is set automatically.

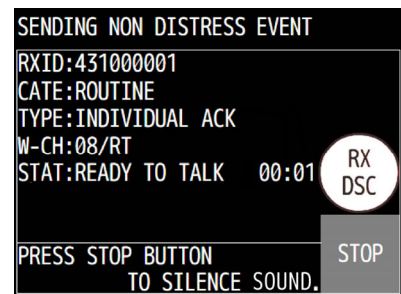

5. After setting the working channel, start communications using the handset.

- The screen as shown at right is displayed.
- When completed the communications, return the handset to the cradle.

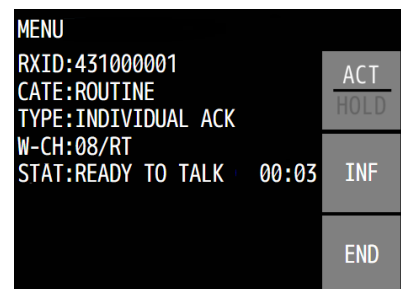

**Note** If the station is unable to comply with the call, own station (caller) may receive one of the following responses. In these cases, if possible according to the message, wait and retry the calling again later. (\* is for the coast station only.)

Message	Content
NO REASON	No reason.
CONGESTION*	The marine exchange center is congested.
BUSY	Busy.
QUEUE	The call has been queued.
BARRED	The station is closed.
NO OPER	Existing no operator.
TEMP NO OPER	The operator is temporarily away.
EQP DISABLED	The equipment has been disabled.
UNABLE CH	The proposed channel cannot be used.
UNABLE MODE	The proposed mode cannot be used.

**4.3.2 Receiving routine individual calls**

When receiving an individual DSC call from a coast or ship station, perform the following procedures as appropriate according to the message.

**■ Procedure ■**

1. The BAM alert screen appears (see Note below) and after touching the [CLOSE] button, the receiving screen at right is displayed with the RX DSC mark flashing for a moment, and the alert sound grows louder gradually.

This example message contains the following information.

- Message type: Individual call
- Caller's MMSI: 431000001
- Object: All modes RT on CH06

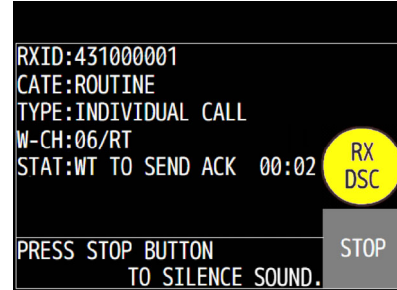

2. Touch the [STOP] button to silence the alert and display the screen at right.

- The following handling menu buttons are displayed.

- ACK: Sends the acknowledgement.
- NACK: Sends the acknowledgement (Unable to comply).
- NEW CH: Sends the acknowledgement with a new channel.
- ACT/HOLD: Switches this event state between Active and On hold.
- INF: Displays the received message.
- END: Terminates the call.

- After selecting the [NACK] button, then select the reason on the UNABLE REASON menu as shown at right.

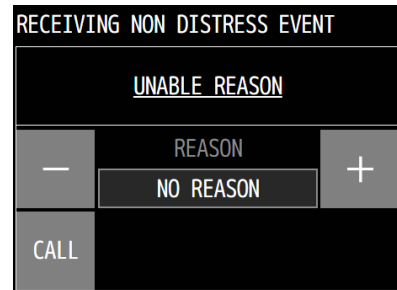
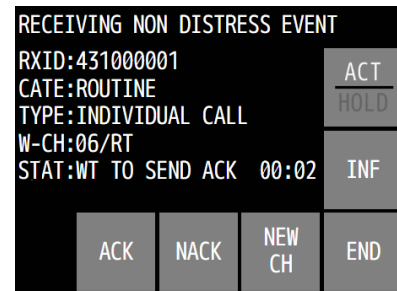

3. To send acknowledgement, touch the [ACK] button.

- The equipment waits for the free channel condition as shown at right, and the acknowledgement is sent.
- Lifting the handset operation also starts sending the acknowledgement as well.

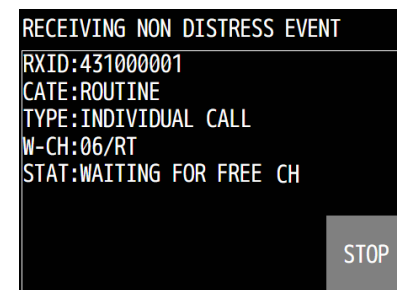

- 4. After sending an acknowledgement, the working channel is set to communicate.

Start communicating using the handset.

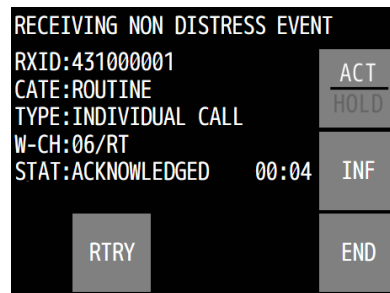

**Note**

- When receiving DSC calls regardless of the category routine, safety, urgency, or distress, the BAM alert screen with the BAM icon and [CLOSE] button immediately appears as follows. Additionally, the BAM treats received routine and safety calls as the caution alerts, and received urgency calls and distress alerts as the warning alerts.

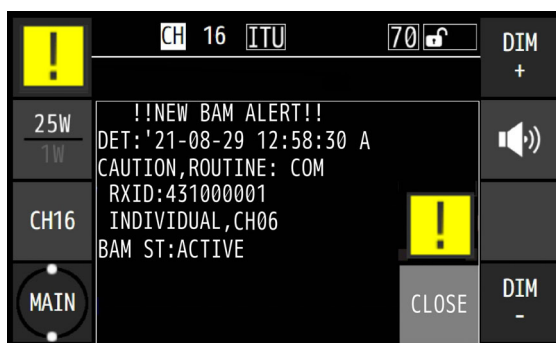

- If NCM-980 controller is connected, only either one unit having priority sounds the DSC reception alerts or BAM audible signals.
- In case of receiving a polling call, the following screen is displayed with the RX DSC mark flashing for a moment, and the alert sound grows louder gradually. Then touch the [STOP] button to silence sound and select [ACK] to send the acknowledgement.

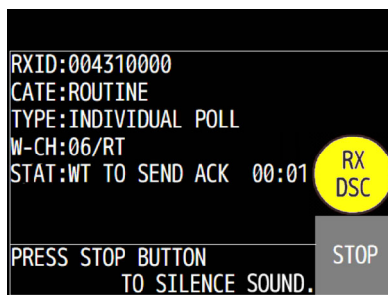

Additionally, if the polling call on the AUTO ACK menu (MENU>SETUP>DSC OPE) is set to on, and if there is no active DSC or non-DSC communication event, this polling call is acknowledged automatically.

### 4.3.3 Routine group calls

For radiotelephone broadcasting, a DSC routine call to a group of stations is available.

#### ■ Procedure ■

1. From the main menu, touch the [CALL] → [EDIT] → [CALL TYPE] buttons.

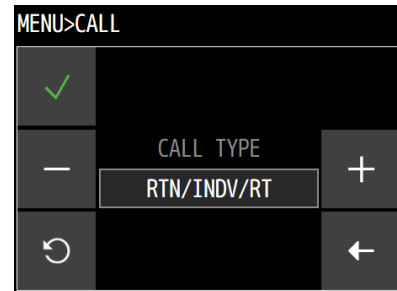

2. Set the CALL TYPE to RTN/GROUP/RT as shown at right and then touch the [✓] button.

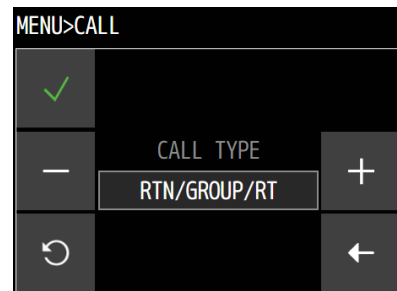

3. The group list registered before is appeared as shown at right (alphabetically sorted) and touch the receiver group for the routine group call.

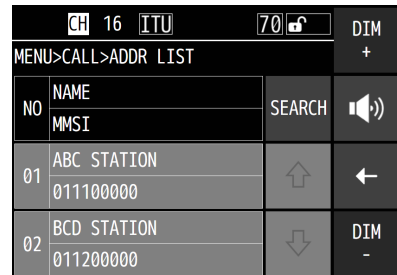

- The working channel is set automatically.
- If the group list is not registered, input manually.

**Note** The group list can be registered on the GROUP menu (MENU> SETUP> ADDR LIST).

4. Touch the [CALL] button to send the group call.

After checking the free channel condition, sends the message.

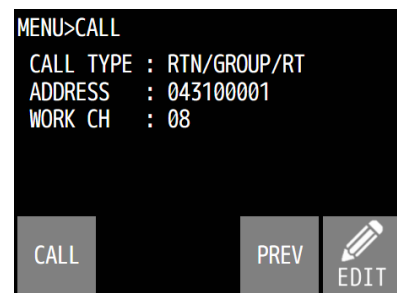

5. After sending the message, the working channel is set and the DSC calling procedure is finished.

Start broadcasting using the handset.

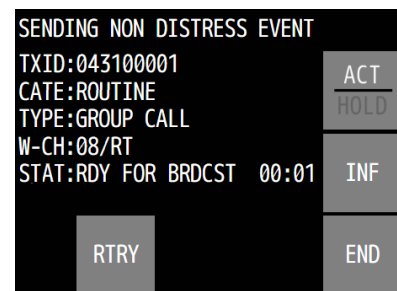

### 4.3.4 Receiving routine group calls

After receiving the DSC group call, the subsequent broadcast is listened on the working channel specified in the DSC message.

#### ■ Procedure ■

The BAM alert screen appears and after touching the [CLOSE] button, the receiving screen at right is displayed with the RX DSC mark flashing for a moment and the alert sound grows louder gradually.

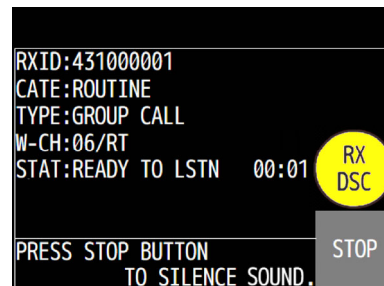

- If there is no active event when receiving the group call, the working channel is immediately set automatically. Additionally, the alert is stopped automatically, but if silencing sound manually, touch the [STOP] button.
- The own ship's group IDs can be registered on the GROUP ID menu (MENU> SETUP> DSC OPE).

**Note**

If the AUTO CH CHG menu is setting to OFF, after touching the [STOP] button, the following popup screen is displayed. In this case, select either one handling menu [ACCEPT] or [IGNORE]. Also, the case of reception of the distress alert, urgency or safety calls are as with this DSC group call.

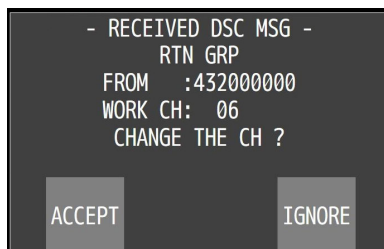

[ACCEPT] Accepts the message and changes to the specified work channel.

[IGNORE] Deletes the popup and return to the previous screen without changing the work channel.

**4.3.5 Communicating with a PSTN subscriber**

The semi/auto mode is used to connect with a public telephone network (PSTN) via a coast station.

**(1) Make a call to a PSTN subscriber**

**■ Procedure ■**

1. From the main menu, touch the [CALL] → [EDIT] → [CALL TYPE] buttons.

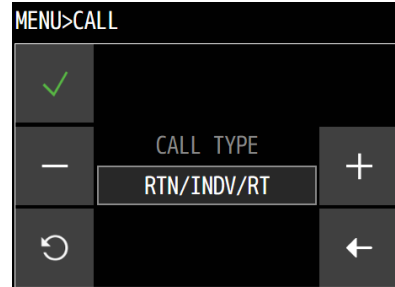

2. Set the CALL TYPE to RTN/PSTN/RT as shown at right and then touch the [✓] button,

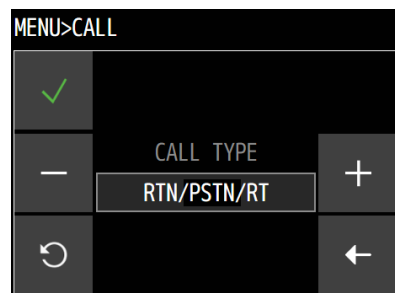

3. The coast station list registered before is appeared as shown at right (alphabetically sorted) and touch the receiver station for the call.

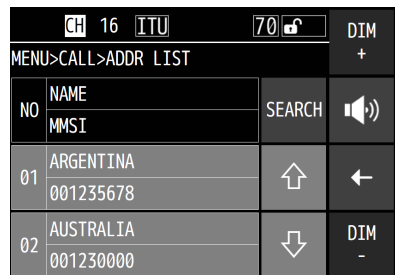

If the coast station list is not registered, input manually.

**Note** The coast station list can be registered on the COAST menu (MENU> SETUP> ADDR LIST).

4. Touch the [EDIT]→[TEL NO] buttons to display the screen at lower right, and input the telephone number to call.

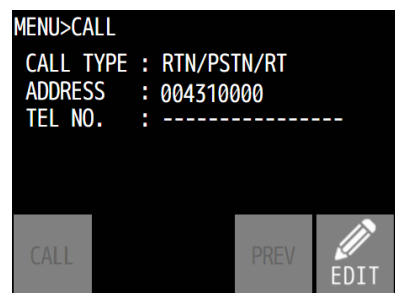

If the telephone number is registered on the PSTN list before, touch the [PSTN LIST] button to display the list.

**Note** The PSTN list can be registered on the PSTN menu (MENU> SETUP> ADDR LIST).

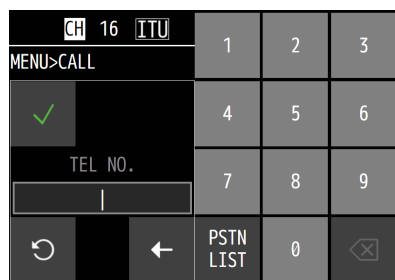

5. Touch the [CALL] button to send the call.

After checking the free channel condition, sends the message. After sending the call, waits for the acknowledgement for 5 sec.

**Note** If received no response within 5sec, sends the call once again. If there is still no response, this call is ceased.

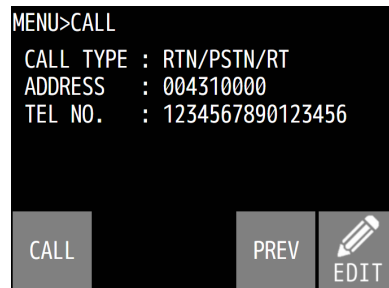

6. After received the acknowledgement, the specified working channel is set.

After the channel changing, a start of call is sent.

**Note** If the channel engaged signal is lost, this call is terminated.

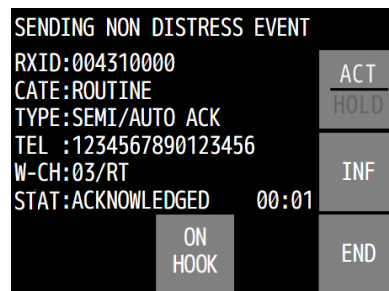

7. The PSTN connection is completed.

Lift the handset from the cradle and wait for the recipient answering the phone (the PSTN dial tone and ring tone from the handset is heard at this time). After answered the phone, the phone call charge is started.

**Note** If not answered within 1 minute, this call is terminated. (It may be similar in the case of bad radio link condition during communication.)

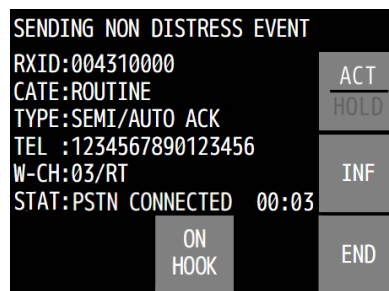

8. To finish the phone call, return the handset to the cradle.

Additionally, the duration is received from the coast station and is displayed as the DUR. The example at right shows 13 minutes and 45 seconds.

**Note**

- According to the coast station, the “unable to comply” acknowledgement mentioned above may be received at step 6.
- If the “unable to comply” acknowledgement indicates “Queue” reason, the wait mode can be selected. The mode enables to continue the above procedure from step 6 after receiving the ring back call. (However, if receiving no call within 15 minutes after receiving "Queue", the ring back mode is canceled. Or if the [CH16] button is touched, the ring-back mode is also cancelled.)

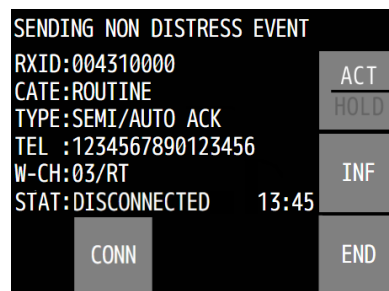

## (2) Receiving a call from a PSTN subscriber

### ■ Procedure ■

1. When receiving a PSTN call from a coast station, if there is no active event, the screen at right is displayed and the equipment starts sending the acknowledgement immediately.

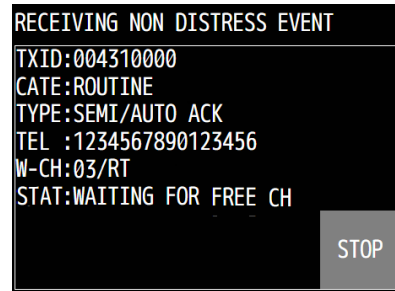

2. After sending the acknowledgement, the screen at right is displayed.

- The ringing sound grows louder gradually.
- The screen at right shows the following information.
  - Coast station ID: 004310000
  - Work Channel: CH03
  - Caller TEL No: 1234567890123456

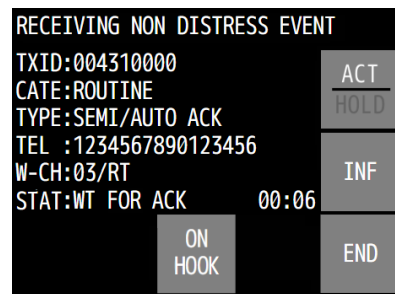

3. If able to comply, lift the handset from the cradle to send the start of call message to start the PSTN communication.

- If not answered within 1 minute, the PSTN call is cancelled automatically.
- If interrupted the receiving signal for 5 seconds during communication, the PSTN call is terminated.

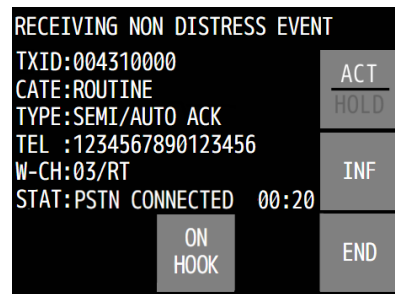

4. When finished the phone call, return the handset to the cradle.

Then an end of call is received from the coast station and the PSTN call is disconnected. However, the duration of the call will not be displayed for free of charge.

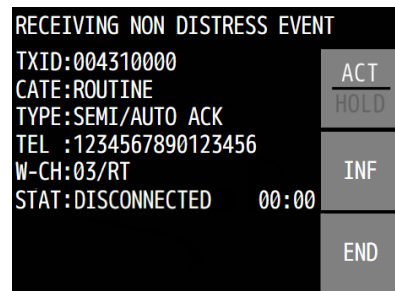



**4.3.6 AIS-linked DSC calls**

The AIS information (nearby ships call signs, names and identification numbers) is displayed as "Other ships list" and are available to call a listed ship via the DSC directly.

NOTE) To use this function, always set IMPORT to ON in the AIS FUNC menu (MENU> SETUP).

**■ Procedure ■**

1. From the main menu, touch the [AIS INFO] → [SHIPS LIST] buttons.

- The screen shown at right is displayed.
- The bearings (BRG) are based on the North-up.
- If Proximity check menu (MENU> AIS INFO> PROX CHECK) is ON and the ships checked at AIS on the station lists are detected in this ships list, the ships information become blue as the checking result.
- If there is no AIS information for other ships, "NO DATA" is displayed.

MENU>AIS INFO>SHIPS LIST			
NO	BRG:RNG	CALLSIGN	GOTO
	MMSI	NAME	
001	100°:00.2NM	JRCAAAA	↑
	112233445	PACUFIC A	
002	359°:00.2NM	JRCBBBB	↓
	222233445	PACUFIC B	

2. Scroll the shops list, if required, and then touch the ship to call.

The category selection screen at right appears.

MENU>AIS INFO>SHIPS LIST	
VESSEL CALL PROCESS SELECT CALL TYPE.	
ROUTINE	SAFETY
URGENCY	CANCEL

3. Select the category button from the routine, safety, or urgency.

The screen at right is displayed. Touch the [CALL] button to call.

MENU>CALL	
CALL TYPE	: RTN/INDV/RT
ADDRESS	: 112233445
WORK CH	: 06
CALL	PREV EDIT

**Note** The rest of the procedure is the same with "4.3.1 Routine calls to an individual station" described above.

## 4.4 Emergency calls (DSC safety/ urgency/ distress calls)

In emergency, the DSC is available for safety/urgency/distress calls. For safety and urgency calls, either individual or all ships is selectable for the type of call. Also, there is a way to send distress alerts after selecting, or not selecting, the type of distress on the menu. In both cases, the dedicated **DISTRESS** button is used to send the distress alerts.

### 4.4.1 Safety or urgency calls to an individual station

#### ■ Procedure ■

Individual safety and urgency calls are basically same as routine calls as described above, except for touching from the main menu, [CALL]→[EDIT]→[CALL TYPE] and then selecting SAF/INDV/RT or URG/INDV/RT.

**Note** Both calls of the safety test and the safety position request are described later.

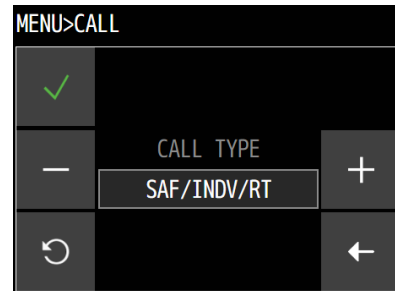

#### 4.4.1.1 Special safety individual calls (test calls and position request calls)

##### (1) Safety test calls

#### ■ Procedure ■

1. Touch the [TEST CALL] button on the main menu.

- Input the address to call from the station list or manually using numeric keypad.
- The station selecting procedure such from the station lists is similar to the routine calls mentioned above.

**Note** When operating from the main menu, touch [CALL]→[EDIT]→[CALL TYPE], and after selecting SAF/INDV/TEST, then input the address to call.

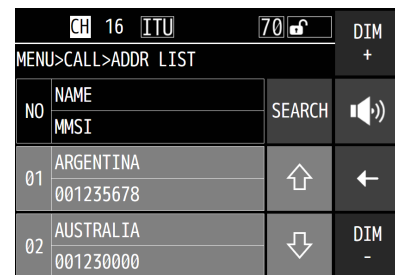

2. Touch the [CALL] button to send the test call.

The screen at right is displayed to check the free channel, and then the safety test call is sent.

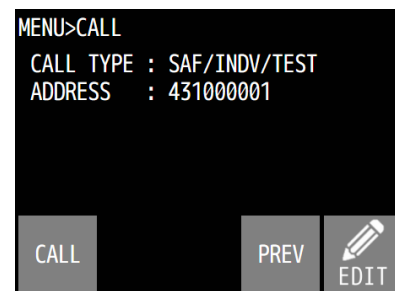

3. When acknowledgement is received, the RX DSC mark flashes and the alert sounds. After silencing it with the [STOP] button, a received screen as shown at right appears.

The safety test call process is now complete. However note that even though the call is sent normally, the acknowledgement may not be received from the called station for some reason.

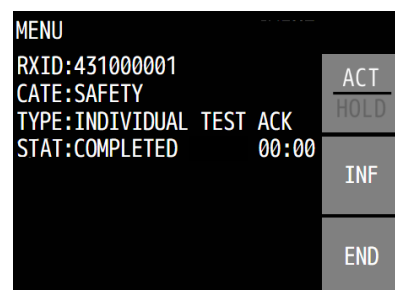

(2) Safety position request calls

■ Procedure ■

1. From the main menu, select [CALL]→[EDIT]→[CALL TYPE] and select SAF/INDV/POSRQ in CALL TYPE.
  - Input the address to call from the station list or manually using numeric keypad.
  - The station selecting procedure such from the station lists is similar to the routine calls mentioned above.

>MENU>CALL>ADDR LIST		
NO	NAME MMSI	SEARCH
01	ABC CARGO 110000000	↑
02	BCD M/V 112111111	↓

2. Touch the [CALL] button to send the position request call.

After checking the free channel, the safety position request call is sent and the screen at right is displayed.

MENU>CALL		
CALL TYPE : SAF/INDV/POSRQ		
ADDRESS : 431000001		
CALL	PREV	EDIT

3. When acknowledgement is received, the RX DSC mark flashes and the alert sounds. After silencing it with the [STOP] button, a received screen as shown at right appears.

The position data of the station is indicated in the Position field usually, and this procedure is complete. However note that even though the call is sent normally, the acknowledgement may not be received from the called station for some reason.

MENU	
RXID:431000001	ACT
CATE:SAFETY	HOLD
TYPE:INDIVIDUAL POS ACK	INF
POS : 12°36'N 123°47'E @12:34	00:05
STAT:COMPLETED	END

**4.4.2 Receiving safety or urgency individual calls**

When receiving an individual DSC call from a coast or ship station, according to the message, perform the following procedures as appropriate.

**■ Procedure ■**

The BAM alert screen appears and after touching the [CLOSE] button, the receiving screen at right is displayed with RX DSC mark flashing for a moment and the alert sound grows louder gradually.

- If no procedure exists, starts operating the received message as the active procedure automatically.
- In the case of an urgency call, the alert sound is stopped by touching the [STOP] button.
- After that, similar as the routine individual calls mentioned above except to use CH16 basically.

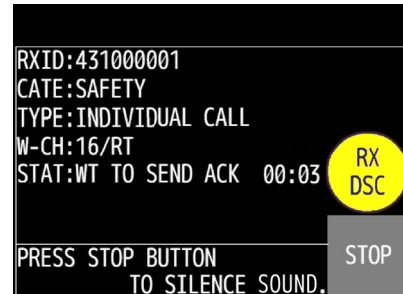

**4.4.2.1 Receiving special safety individual calls (test calls and position request calls)**

(1) Receiving safety test calls

**■ Procedure ■**

The BAM alert screen appears and after touching the [CLOSE] button, the receiving screen at right is displayed with RX DSC mark flashing for a moment and the alert sound grows louder gradually.

- If there is no active event, and TEST on the AUTO ACK menu (MENU>SETUP>DSC OPE) is ON, then the call is acknowledged automatically.
- To acknowledge manually, after silencing the sound with the [STOP] button, touch the [ACK] button.

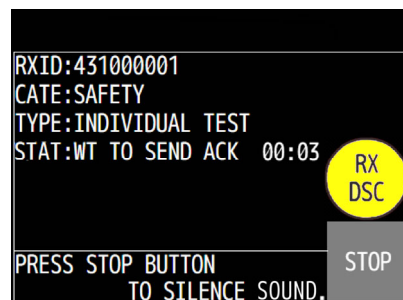

(2) Receiving safety position request calls

**■ Procedure ■**

The BAM alert screen appears and after touching the [CLOSE] button, the receiving screen at right is displayed with RX DSC mark flashing for a moment and the alert sound grows louder gradually.

- If there is no active event, and POSITION RQ on the AUTO ACK menu (MENU>SETUP>DSC OPE) is ON, then the call is acknowledged automatically.
- To acknowledge manually, after silencing the sound with the [STOP] button, touch the [ACK] button.
- To send the acknowledgement (unable to comply), touch the [NACK] button.

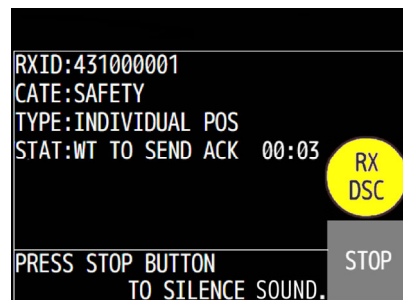

**4.4.3 Safety or urgency all ships calls**

The DSC safety all ships calls can be made as follows.

**■ Procedure ■**

1. From the main menu, touch the [CALL]→[EDIT]→[CALL TYPE] buttons. Then select SAF/ALL/RT or URG/ALL/RT and touch the [✓] button.

Change the working channel, if required.

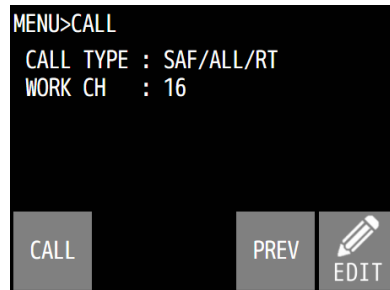

2. Touch the [CALL] button to send.

After checking the free channel, the message is sent.

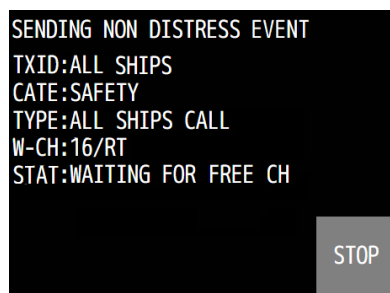

3. After sending the message, the working channel is set.

Start broadcasting using the handset.

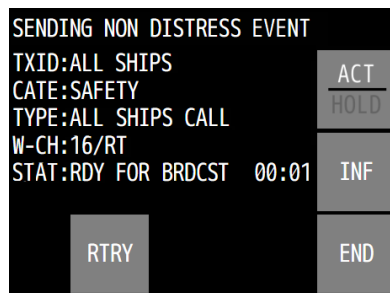

**Note**

For an urgency call, special subject such as either medical transport (MEDICAL TRNSP) or neutral ship (NEUTRAL SHIP) can be conveyed by adding the information in the DSC message.

To use this function, after every powering on the equipment, set either MDCL USE or NEUT USE to ON as the special subject on the DSC OPE menu (MENU> SETUP).

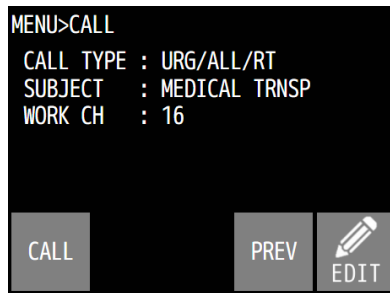
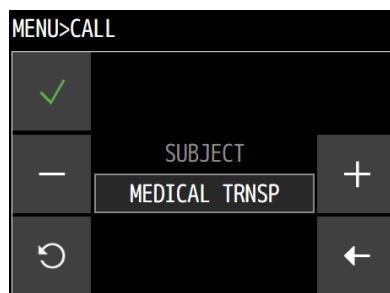

#### 4.4.4 Receiving safety or urgency all ships calls

##### ■ Procedure ■

The BAM alert screen appears and after touching the [CLOSE] button, the receiving screen at right is displayed with the flashing RX DSC mark and the DSC reception alert sound grows louder gradually.

- If there is no active event, starts operating the received message as the active event automatically.
- To stop the urgency alert, touch the [STOP] button.

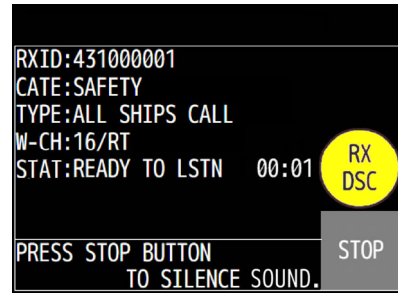

##### Note

- To check the topic for Medical transport or Neutral ship when receiving an urgency all ships call, select INF menu to view the detail of the message.
- If the Auto CH CHG is setting to OFF, after touching the [STOP] button, the popup screen is displayed. In this case, select either one handling menu [ACCEPT] or [IGNORE].

#### 4.4.5 Distress alerts

When in distress, press the dedicated **DISTRESS** button to send a distress alert. The distress alerts send own MMSI, ships position, time of the position, and the nature of distress.



## CAUTION



Do not test the distress alert as doing so may inconvenience local shipping and Rescue Centers.



When sending a distress alert, follow the instructions of the ship's captain or officer in charge.



If a false distress alert is transmitted accidentally, use the [CANCEL] button to cancel transmission of the distress alert. And then report the false distress alert to a nearby RCC (Rescue Coordination Center, in Japan, inform the nearest Japan Coast Guard.) Information to be reported:

Ship's name, type, nationality, and ID number, the date/time, location and reason why the false distress alert was transmitted. Also, report the unit model name and manufacture number/date, if possible.

#### 4.4.5.1 Quick distress alerts

The following describes the procedure to send a distress alert immediately without using menus. In this case, the nature of distress in the message is sent as "UNDESIGNATED" by default. Further, if no information for the position and the time of position obtained within 23.5 hours, the information are composed automatically as "999999999" and "8888" respectively.

##### ■ Procedure ■

1. Open the **DISTRESS** button cover.



## Operation

- Press and hold the **DISTRESS** button for at least 3 seconds until the countdown is completed.



- The distress alert is sent.

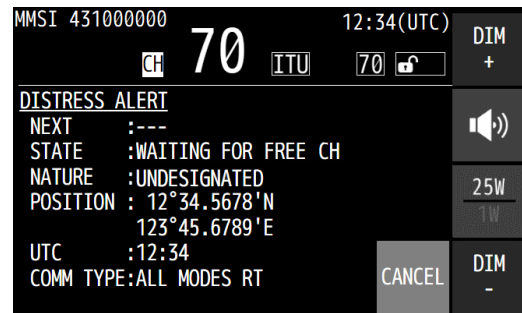

- After sending the distress alert, wait for the acknowledgement in the condition of the activated distress transmission procedure.

- Unless an acknowledgement is received or the distress alert is cancelled manually, the distress alert repeats automatically in a variable interval every 3.5 to 4.5 minutes. (The time until next sending is shown at Next.)
- While waiting for the acknowledgement, the radiotelephone communication and resending the distress alert by pressing **DISTRESS** button are available.
- Option menus are available as follows.
  - PAUSE: Makes the distress mode pause.
  - CANCEL: Starts the distress alert cancelling procedure, which is needed to send the DSC acknowledgement and to broadcast from the own ship

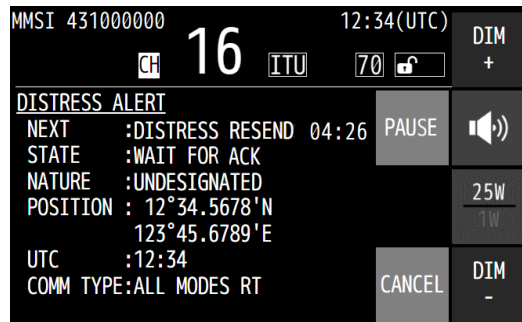

- When acknowledged, the screen at right is displayed.

- The RX DSC mark flashes and the alert sounds.
- Touch the [STOP] button to silence the sound and then call for help with the handset.
- First, the responding station will call on the CH16. Then acknowledge the receipt as follows.
  - Say "MAYDAY",
  - Say "this is",
  - Own ship's MMSI and call sign, position, nature of distress, and rescue requests

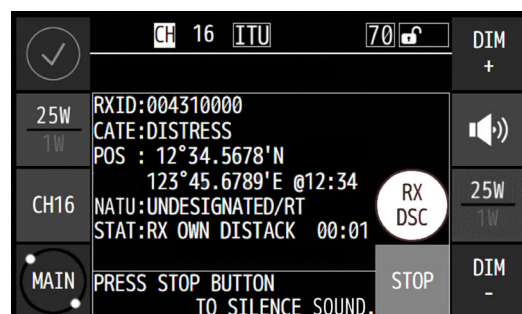



**Note**

If cancelling the distress alert since a false distress alert is transmitted accidentally, perform the distress alert cancelling procedure as follows.

1. Touch the [CANCEL] button on the distress alert screen to display the popup screen at right.

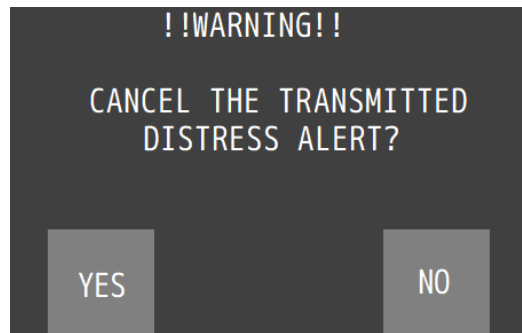

2. Touch the [YES] button.  
The distress acknowledgement to own ship is sent immediately.

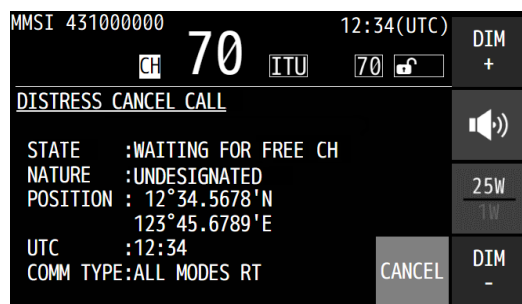

3. After DSC acknowledgement is complete, the popup screen at right appears.

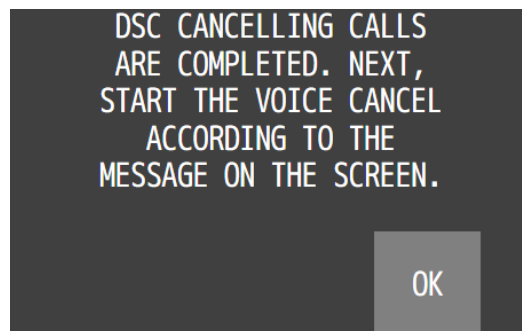

4. Touch the [OK] button and according to the guidance on the screen, broadcast to cancel the distress alert.

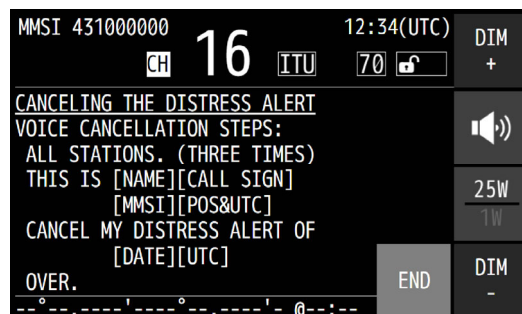

5. Touch the [END] button when the broadcast to cancel the distress alert is complete.  
The distress mode ends.

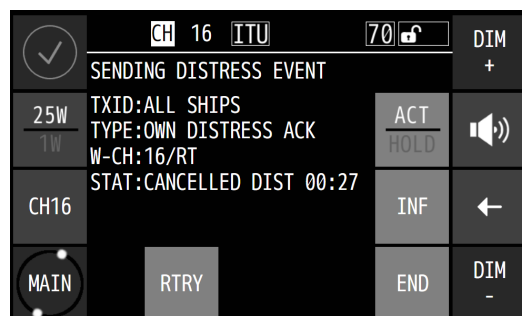

### 4.4.5.2 Distress alerts from the menu

The following describes the procedure to send a distress alert with the nature of distress selected in the menu. Also, if there is no valid information regarding the position and the time of position, the manual input is available in that menu.

#### ■ Procedure ■

1. On the status display, touch the [DIST-E] button.

The nature of distress is displayed as UNDESIGNATED as a default value. If the position information is input automatically by a GPS type device, or has already been input manually, that information is also displayed.

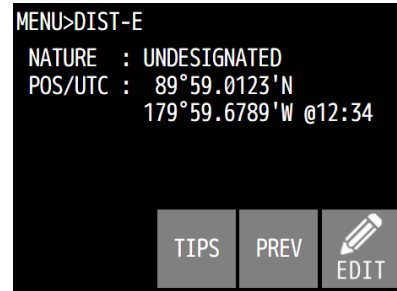

2. Touch the [EDIT]→[NATURE] buttons.

Select the nature of distress from those below and then touch the [✓] button to enter it.

Nature of distress	Contents
FIRE	Fire, explosion
FLOODING	Flooding
COLLISION	Collision
GROUNDING	Grounding
LISTING	Listing, in danger of capsizing
SINKING	Sinking
DISABLED	Disabled and adrift
UNDESIGNATED	Undesignated distress
ABANDONING	Abandoning ship
PIRACY ATTACK	Piracy/armed robbery attack
MAN OVERBOARD	Man overboard

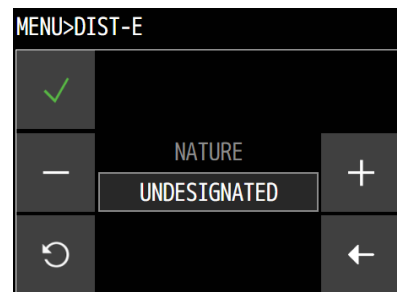

If the valid position and time of the position are already displayed, skip to step 5 because no entry is needed.

3. Touch the [EDIT]→[POS UTC] buttons.

First, set the SOURCE to MAN to input manually.

#### 1. OWN POSITION

SOURCE: Select ship position source from below.

- MAN ···· Manual input
- GPS ···· External positioning system
- CLEAR · No selection

COORDINATE: NE/ NW/ SE/ SW

LATITUDE/ LONGITUDE:

#### 2. UTC OF POSITION

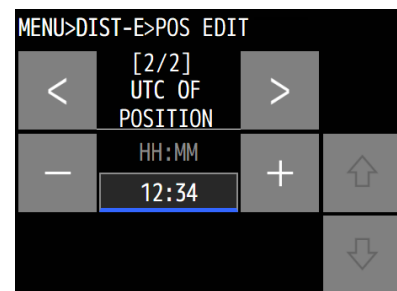
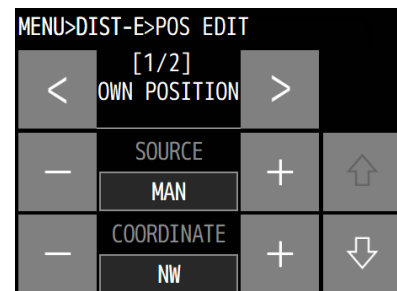

4. After editing, touch the [✓] button to enter them.

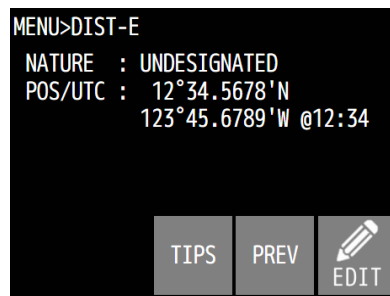

**Note**

- Touching the [TIPS] button shows the precautions about operations of this screen as shown at right.

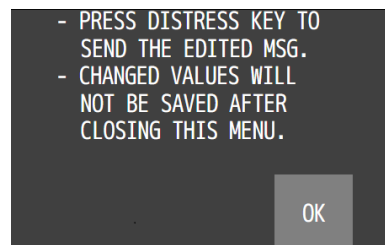

- Touching the [PREV] button shows the entire distress message as shown at right.

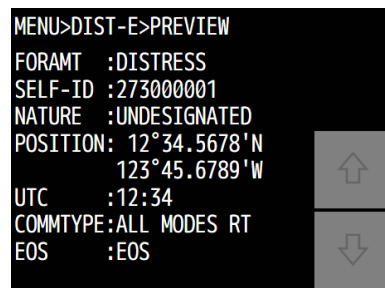

5. Open the **DISTRESS** button cover.



6. Press and hold the DISTRESS button for at least 3 seconds until the countdown is completed.

The rest of the procedure is the same as described in the "Quick distress alert".

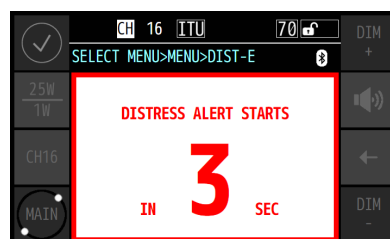

### 4.4.5.3 Receiving distress alerts

When a distress alert is received from another ship, displays the event immediately with the specific two-tone alert sound.



## WARNING



If a distress alert is received, make sure to inform the ship's captain or officer in charge. Doing so may save the lives of the crews and passengers on the ship in distress.

#### ■ Procedure ■

1. When a distress alert is received, the BAM alert screen appears and after touching the [CLOSE] button, the distress message screen as shown at right is displayed.

- The flashing RX DSC mark is displayed and the alert sound gradually grows louder.
- If no procedure exists, starts operating the received message automatically.

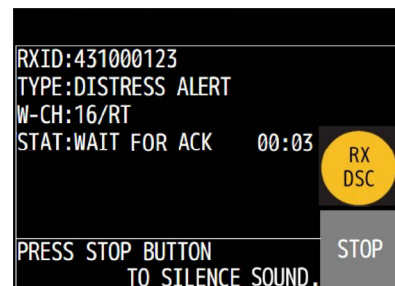

2. Touch the [STOP] button to silence the sound and display the screen at right.

- The screen as shown at right is displayed. Keep watch for at least 5 minutes, and then notify the coast station as appropriate.
- Use the following handling menu, if required.
  - ACK: Sends the acknowledgement.
  - RLY: Sends the distress relay.
  - INF: Indicates the received distress message.
  - ACT/HOLD: Switches this event state between Active and On hold.
  - END: Terminates the procedure.

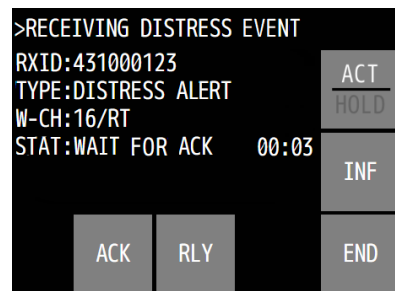

**Note**

- The distress acknowledgement is normally sent from a coast station. However after consulting with the RCC or a coast station and being directed, it is possible to acknowledge the ship in distress from your own ship.
- After sending the acknowledgement, start communicating with the ship in distress according to the following procedure.
  - Say "MAYDAY".
  - Repeat the identity (MMSI) of the ship in distress 3 times
  - Say "This is..."
  - Repeat the identity (MMSI) of your ship 3 times
  - Say "RECEIVED MAYDAY".
- The distress relay calls may be received without receiving the distress alert. In this case, keep watch the CH16 and handle the message using the displayed options as appropriate.
- If the Auto CH CHG is setting to OFF, after touching the [STOP] button, the popup screen is displayed. In this case, select either one handling menu [ACCEPT] or [IGNORE].
- If the case of receiving the distress alerts of the nature of distress "MAN OVERBOARD (MOB)", then multiple alerts from different MOB devices is handled as one DSC call event.

**4.4.6 Distress relay calls on behalf of someone else (DROBOSE)**

If another ship is in distress but is itself unable to make a distress alert, and the master of the ship considers that further help is necessary, the distress relay call on behalf of the ship can be transmitted using "DSC drobose call" menu. In this case, compose a distress relay call format by inputting the MMSI (if known), the ship's position and the time of position (if known), and the nature of distress to send to all ships or a coast station.



## CAUTION



When sending a drobose call, do NOT press the **DISTRESS** button but use the [CALL] button displayed on the screen.

■ Procedure ■

1. On the status display, touch the [RELAY] button.

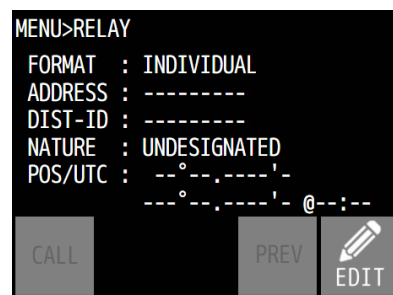

2. To individually call a coast station, touch the [EDIT]→[ADDR] buttons, and input the MMSI.

- Input the address to call from the station list or manually using numeric keypad.
- The station selecting procedure such from the station lists is similar to the routine calls mentioned above.

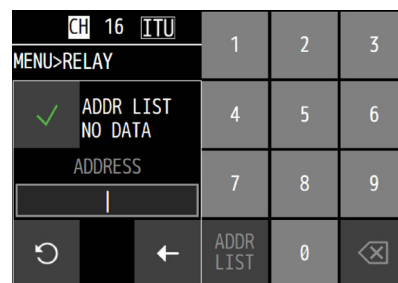

**Note** For all ships calls, touch the [EDIT]→[FORMAT] buttons, and then the [✓] button.

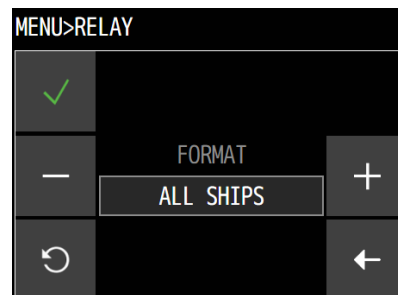

## Operation

- Input the distress ID (MMSI) of the ship in distress, nature of distress, and the position and that time on the EDIT menu, if known, and then touch the [✓] button.

The nature of distress is selectable from below.

Nature of distress	Contents
FIRE	Fire, explosion
FLOODING	Flooding
COLLISION	Collision
GROUNDING	Grounding
LISTING	Listing, in danger of capsizing
SINKING	Sinking
DISABLED	Disabled and adrift
UNDESIGNATED	Undesignated distress
ABANDONING	Abandoning ship
PIRACY ATTACK	Piracy/armed robbery attack
MAN OVERBOARD	Man overboard
EPIRB EMISSION	Received DSC VHF EPIRB signal

- After entering the distress information, touch the [CALL] button.

After checking the free channel condition, sends the distress call. In case of the coast station call, wait for the acknowledgement.

- When the acknowledgement is received from the coast station, the screen as shown at right is displayed.

- The RX DSC mark flashes and the alert sounds.
- After touching the [STOP] to silence the sound, then start the distress traffic.

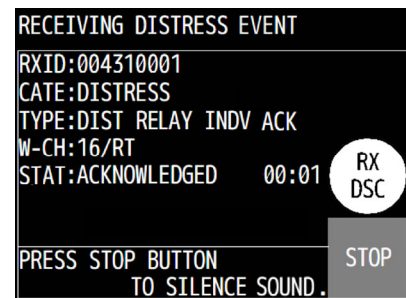
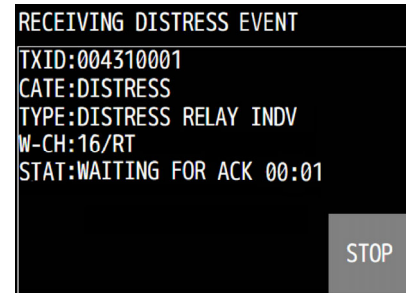
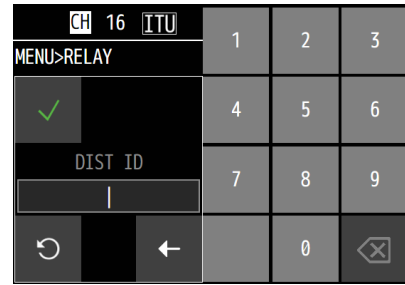

## 4.5 DSC call log

Received DSC messages are classified as distress messages and as other messages. The 20 most recent messages for both types of received and transmitted are saved in the log.

### 4.5.1 Received distress messages

Received messages regarding distress alerts and the acknowledgements, distress relay calls and the acknowledgements are displayed in this received distress message log. However when receiving a distress alert containing the same 5 messages, only one of those is stored.

#### ■ Procedure ■

1. From the main menu, touch the [DSC LOGS]→ [RX DIST] buttons.

- Received distress message list is displayed.
- In case of messages including receiving errors (ECC error), "ECC ERROR" appears in the TYPE field.

MENU>DSC LOGS>RX DIST			
NO	DATE/TIME		GOTO
	FROM	TYPE	
01	'17-10-31	11:20	↑
	431012340	ACK	
02	'17-10-31	11:15	↓
	431012350	DISTRESS	

2. Scroll the list, if required, and then touch the message to display.

- The selected message is displayed.
- SUM is the total number of the same distress alert received as the "5 times calls".

MENU>DSC LOGS>RX DIST>DETAIL	
TYPE	:DISTRESS ALERT
FROM	:431012350
NATURE	:FIRE
POS	: 34°00.5678'N 120°00.6789'W
UTC	:14:55
MODE	:ALL MODES RT
EOS	:EOS
SUM	:5/5

### 4.5.2 Received other messages

Received messages regarding routine, safety, and urgency calls or the acknowledgements is displayed in this received other message log.

#### ■ Procedure ■

1. From the main menu, touch the [DSC LOGS]→ [RX OTHERS] buttons to display it.

- Received non distress message list is displayed.
- In case of messages including receiving errors (ECC error), "ECC ERROR" appears in the TYPE field.

MENU>DSC LOGS>RX OTHERS				
NO	DATE/TIME			GOTO
	FROM	CATE	FMT	
01	'17-10-23	15:30		↑
	123456789	RTN	INDV	
02	'17-10-20	22:15		↓
	223456789	URG	ACK	

2. Scroll the list, if required, and then touch the message to display.

- The selected message is displayed.
- The caller's ID can be registered to the station list using the [MMSI REG] button.

>DSC LOGS>RX OTHERS>DETAIL	
CATE :ROUTINE	PRINT
TYPE :INDIVIDUAL CALL	
FROM :123456789	
MODE :ALL MODES RT	
W-CH :10	
EOS :ACK RQ	
	MMSI REG

### 4.5.3 Transmitted messages

Every transmitted message is displayed in this Transmitted message log.

#### ■ Procedure ■

1. From the main menu, touch the [DSC LOGS] → [TX CALLS] buttons.

MENU>DSC LOGS>TX CALLS				
NO	DATE/TIME			GOTO
	FROM	CATE	FMT	
01	'17-11-23	12:30		↑
	123456789	RTN	INDV	
02	'17-10-15	22:15		↓
	223456789	SAF	ALL	

2. Scroll the list, if required, and then touch the message to display

The selected message is displayed.

MENU>DSC LOGS>TX CALLS>DETAIL	
CATE :ROUTINE	PRINT
TYPE :INDIVIDUAL CALL	
TO :123456789	
MODE :ALL MODES RT	
W-CH :10	
EOS :ACK RQ	



## 4.6 Other features

In addition to the features described above, the equipment contains useful some features as below.

### 4.6.1 Notification of registered ships by the AIS

If the AIS is connected and set to available by the concerned settings, when ships registered in the station list falls within the specified range, the information is noticed immediately.

#### ■ Procedure ■

1. From the main menu, touch the [AIS INFO] → [PROX CHECK] buttons.

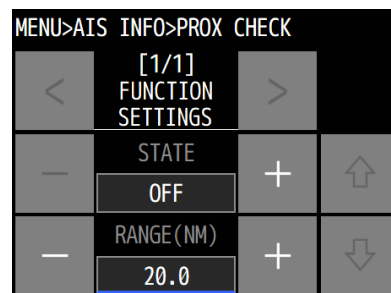

2. Set the STATE to ON.

Input the appropriate value within the range of 0.1 to 99.9NM with the numeric keypad to the RANGE as the ships search area, if required.

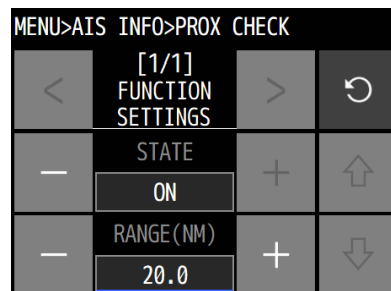

3. To finish registering the settings, touch the [✓] button to save.

**Note**

When the registered ship is detected within the specified proximity range, the screen at right is appeared immediately.

However, if the AIS information does not contain the ship's name, the NAME line is replaced by the MMSI number.

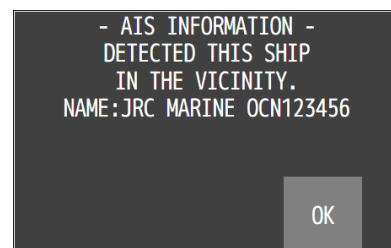

**4.6.2 Playback of received voice**

When the squelch is opened, the received voices are automatically recorded (up to 480 seconds) and can be replayed to confirm audio communications. Recorded voices are divided into multiple tracks depending on the time for the squelch open/close, and stored until power off. If the total recorded time of all tracks reaches 480 seconds, the oldest recorded track is overwritten.

**(1) Replay and stop operations**

**■ Procedure ■**

1. From the main menu, touch the [VOICE FUNC] → [PLAY-BACK] buttons.

- If existing any recorded tracks, replays the latest track immediately.
- The example at right shows the following.
  - Replaying track number: 1
  - Total track numbers: 12
  - Counter value (elapsed time): 2 seconds
  - Recorded time of the track: 36 seconds

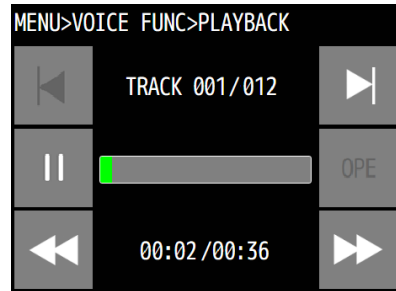



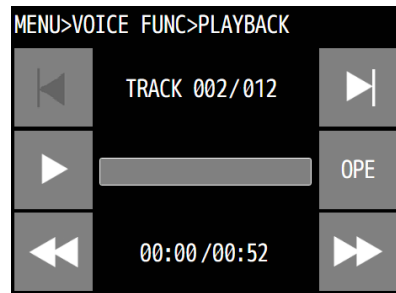

2. After finishing the playback of a track, the next track is displayed and the playback mode stops.



## (2) Fast forward and rewind operations

During playback, the fast forward or rewind is available by the following procedure.

### ■ Procedure ■

1. Touch  or  during playback.
  - Touching  fast forwards and increases the counter value.
  - Touching  rewinds and decreases the counter value.
2. Touching  starts playback from the time on the counter.

## (3) Temporary track saving

Normally, when the total recorded time of all tracks reaches 480 seconds, the oldest track is overwritten by a new track. However the track can be saved temporarily using the following procedure until power off.

### ■ Procedure ■

1. In the stop mode, use  or  to display the track to save temporarily.

The example at right shows the case of track 1 selected.

**Note** Only 1 track can be saved.



2. Touch the [OPE] → [SAVE] buttons.
  - A beep sounds when saving is complete, and the track number changes from "001" to "S", as is shown at right.
  - The saved track is registered as the last number. In the example at right, it is track 12.

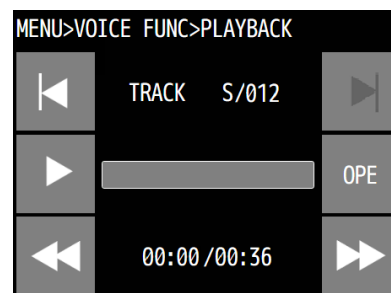



**Note** When the saving is complete, the subsequent track numbers is shifted down by 1.

## (4) The saved track deletion

---

To delete a saved track, perform the following procedure. (Powering off deletes all tracks.)

### ■ Procedure ■

1. In the stop mode, use  or  to display the track to delete.

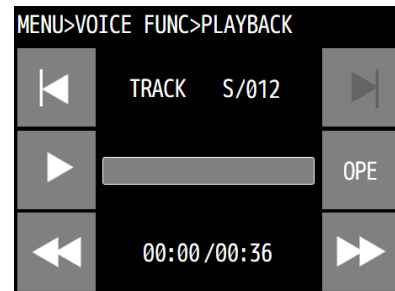

2. Touch the [OPE] → [ERASE] buttons.  
The confirmation message is appeared.

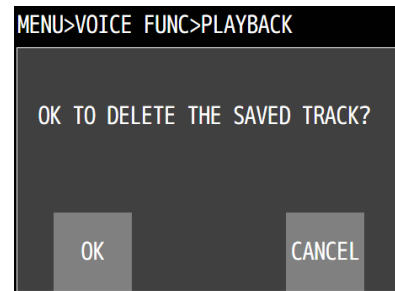

3. After confirming the message, touch the [OK] button to delete the saved track.  
After deleting is complete, track 1 appears, as shown at right.

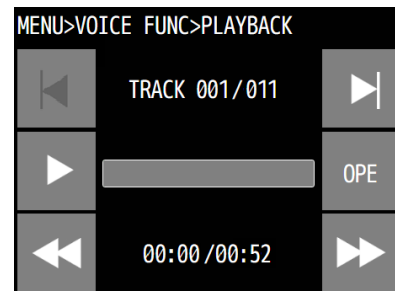

### 4.6.3 Public Address function with an external speaker (option)

If an external speaker is connected, the Public Addresser (hereinafter the "PA") mode is available to make an announcement over the external speaker. While the PA mode is in use, the received voices are not recorded even if the squelch is opened.

#### ■ Procedure ■

1. Lift the handset from the cradle, and then from the main menu, touch the [VOICE FUNC]→[PUBLIC ADDR] buttons.
  - The PA mode starts and enabled to make an announcement over the external speaker.
  - Press PTT key to talk.
  - To finish the PA mode and return to the status display, replace the handset on-hook.  
(Also, finish the PA mode and return to the previous screen, touch the [FINISH] button.)

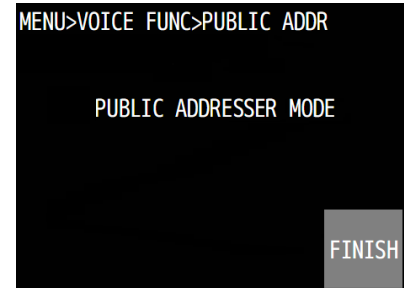
**Note**

In this mode, pressing the PTT makes no transmission at all.

**4.6.4 Intercom**

If one or more controllers (NCM-980) are connected to the main unit (JHS-800S), the intercom is available between two units of the main unit and/or the controller(s). While the intercom is in use, the received voices will not be recorded even if the squelch is opened.

**(1) Calling and talking**

**■ Procedure ■**

1. Lift the handset from the cradle and then touch the [MENU]→[VOICE FUNC]→[INTCOM] buttons.

- The main unit and controllers list is displayed.
- The example at right shows that the following controllers are connected.
  - Address 1: Calling main unit
  - Address 2: Station.02
  - Address 3: Station.03
  - Address 4: Station.04
  - Address 5: Not connected

MENU>VOICE FUNC>INTERCOM	
(OWN STATION)	STATION.02
STATION.03	STATION.04
(N/A)	

2. Touch the button of the controller to call.

- The screen at right is displayed and the intercom call is started.
- Replacing the handset on-hook while calling finishes calling and returns to the status display.
- Touching the [CANCEL] button while calling finishes calling and returns the screen to the step 1.

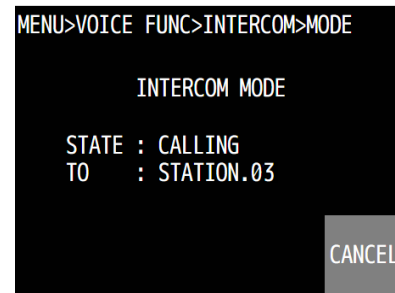

**Note** - If the handset of the recipient is left off-hook, the call is not started and the screen at right is displayed. Then touch the [FINISH] button to finish calling and return to the step 1.

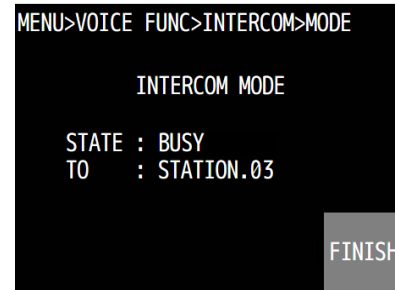

- If not answered within 30 seconds, the screen at right is displayed. Then touch the [OK] button to return to the step 1.

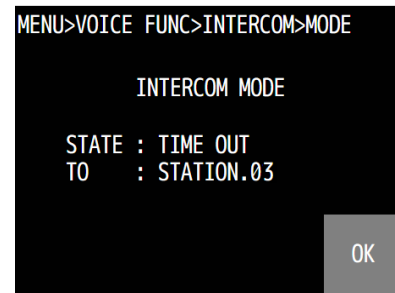

3. After answered the phone, the screen shown at right is displayed and enabled to start the communication.

- Press PTT key to talk.
- To finish the intercom, touch the [FINISH] button or replace the handset on-hook.

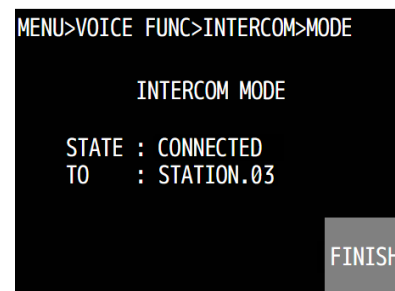

## (2) Receiving a call from another controller

### ■ Procedure ■

1. If received an intercom call, the screen at right is displayed and the ringing is started.

If not answered within 30 seconds, the state changes busy. Also, touching the [CANCEL] button returns the screen to the status display. Additionally, touching the [ACCEPT] button makes the CONNECTED state.

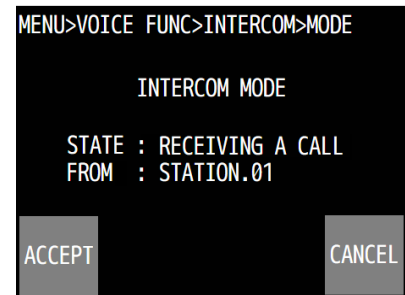

2. When answering to the call, lift the handset and start the communication.

- Press PTT key to talk.
- To finish the intercom, touch the [FINISH] button or replace the handset on-hook.

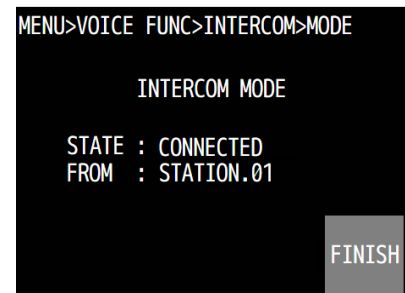

#### Note

- The OCC mark remains displayed even while talking, because the called controller (recipient) is in monitor mode.
- While using the intercom function between two control panels, if the other main unit or the other connected controllers, those screens display as shown at right.

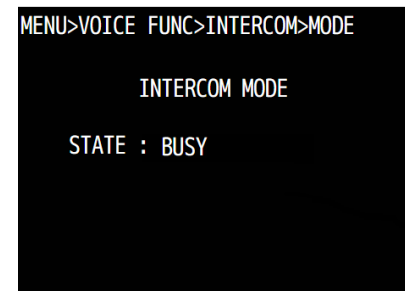

### 4.6.5 Talk with a wireless speaker microphone

Radiotelephony communication with other stations using the Bluetooth type wireless speaker microphone (option) is available. And also, this wireless speaker microphone is available for the intercom between the main unit and/or controllers.

#### (1) Pairing

##### ■ Procedure ■

1. Check if the Bluetooth logo  is indicated on the upper line of the screen

If the logo is not indicated on the screen, from the main menu, touch the [SETUP]→ [BT-SET]→ [BT FUNC] buttons and change the BT SPMIC USE to ON, and then touch the [✓] button to save it.

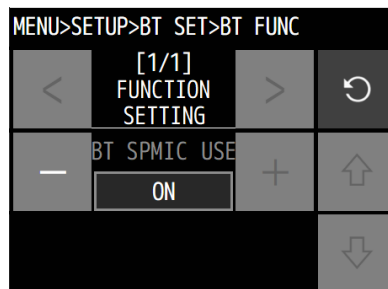

2. Set the Bluetooth type wireless speaker microphone to the pairing mode.

In case of the BTR-155 manufactured by SAVOX at right, when the device is off, press and hold the multi function button for 5 sec to start the pairing mode with flashing the blue and red light alternately. For more details, refer to the instruction manual of the BTR-155.



(BTR-155 manufactured by SAVOX)

3. From the main menu, touch the [SETUP]→ [BT SET] → [BT PAIR] buttons to start the pairing.

- The screen at right is appeared and start searching the pairing.
- When the search is complete, the device name and the MAC address are appeared on the screen as shown at lower right.

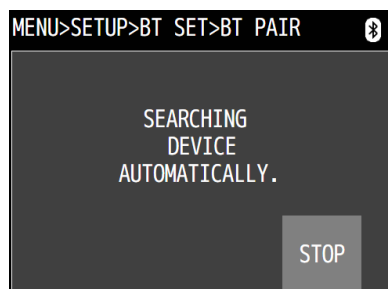

4. Touch the targeted wireless speaker microphone to complete the pairing.

After the pairing is finished successfully, the Bluetooth logo  becomes blue.

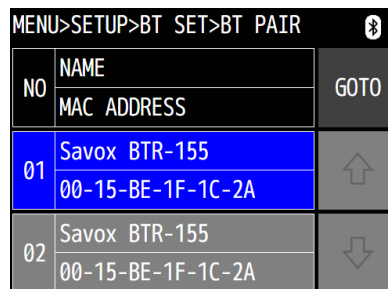

**Note** The latest pairing information is registered in the control panel of the main unit (JHS-800S) or controller (NCM-980). So once the pairing is finished, after that the pairing is immediately finished just only powering on the both devices.

#### (2) Making calls

The communication method using the wireless speaker microphone is basically same as the handset except for the functions concerning the cradle such as on-hook and off-hook.



**4.6.6 Change river channels using block channel function**

The inland waterways in Europe are divided to many block areas and one specified VHF channel is used in each block area to communicate between the ship and the land radio station of the block. In such circumstances, corresponding to the block area of the ship's position, the VHF channel has to be checked and changed by crews manually on the route. Therefore, to make it easier for them, the block channel function (BCF) is available.

NOTE) To use this function, previously register the waypoints on the rivers including changing channel information using BLOCK CH menu. For more details, see the section 5.6.4.

■ Procedure ■

1. From the main menu, touch the [CH OPE]→[BCF START] buttons.

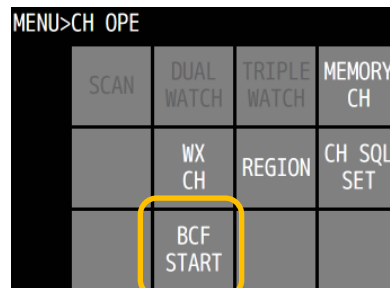

2. After selecting of MANUAL or AUTO, touch the [START] button to start BCF.

- MANUAL: BCF works as a channel proposal type to set the channel manually.
- AUTO: BCF works as the automatic type to set channels automatically.



3. After starting the BCF, the regular screen shows BCF(M) or BCF(A) as shown at right.

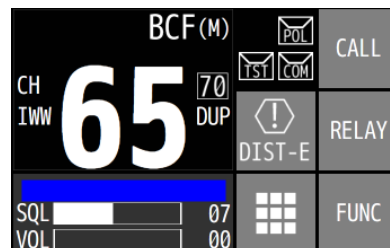

4. When the ship crosses into a registered waypoint area, the popup screen as shown at right is appeared.

- Touch the proposed channel button or CANCEL button corresponding to the situation.
- First 6 letters of the block name is displayed on top of the proposed channel button.
- If 3 channels are registered in the waypoint, the screen shows 2 or 3 channel buttons.
- If only 1 channel is registered in the waypoint area and the JHS-800S has already been set to the same channel, the JHS-800S recognizes that the area is terminal. And then, the popup screen at right is shown and the BCF is finished automatically.

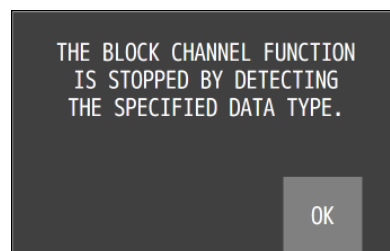
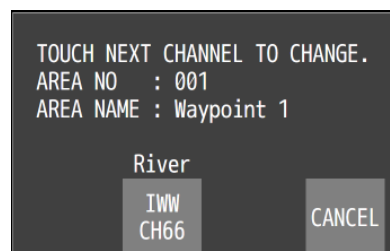

## Operation

5. After touching the proposed channel button, the channel is changed and the screen at right is shown.

- The registered block name is appeared on the blue line as shown at right.
- Even though during the BCF operation, changing the channel manually is always available.
- In the above step 4, if the CANCEL button is touched, the proposal channel button is placed at the position of the User key as shown at right.

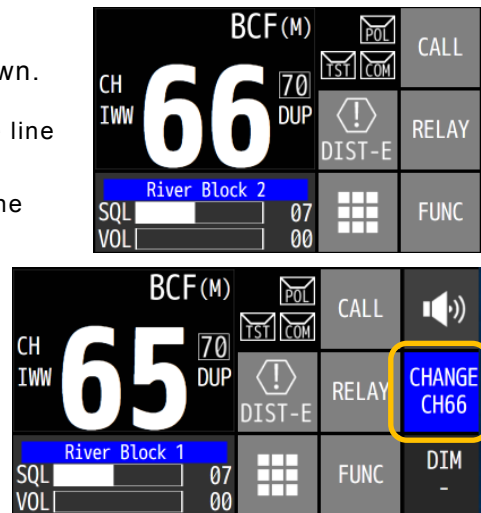

6. To finish the BCF operation, from the main menu, touch the [CH OPE]→[BCF STOP] buttons.

- The [BCF START] and [BCF STOP] buttons are placed at the same position alternately.
- Also, if the JHS-800S detects the GPS signal disruption, the popup screen at lower right is appeared and the BCF is stopped immediately.

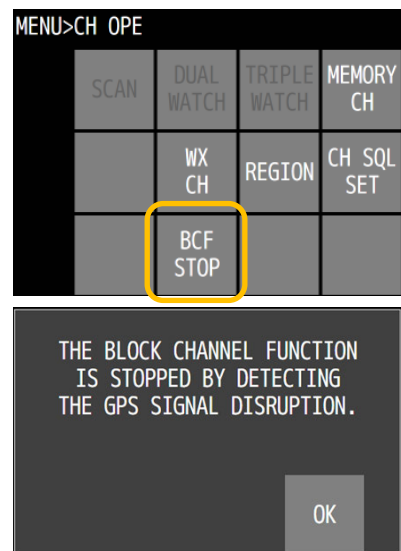

## 5. SETTINGS & REGISTRATIONS

This chapter describes the procedure for settings and registrations for the date and time manually, the contact lists for DSC calls, advanced DSC settings, and other settings for the equipment.

### 5.1 Date and time setting

Normally, the date and time are updated automatically if importing GPS information. But if necessary, input these parameters manually as follows.

#### ■ Procedure ■

1. From the main menu, touch the [SETUP] → [DATE&TIME] buttons.

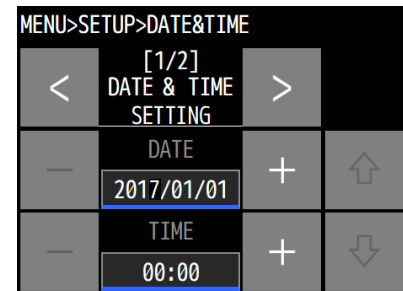

2. Input the date and time information manually and then touch the [✓] button to save them.

This menu includes the following settings

1. DATE & TIME SETTING
2. DISP FORM

TYPE : Indication type on the status display from below;  
 TIME,POS/ TIME only/ POS only

UTC/LT : Universal Time Coordinated/ Local Time

LT DIFF : Setting of the time difference between UTC and LT

DATA FORMAT : Date and time form of DSC messages selectable from below;  
 'YY-MM-DD/ MMM DD,'YY/ DD MMM,'YY

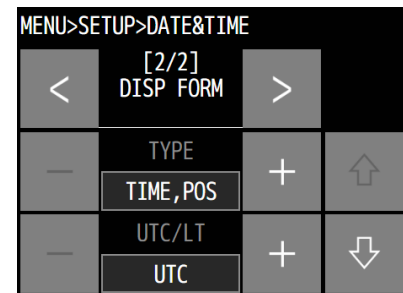

## 5.2 Own ship position and time setting

Normally, the ship's position and the time are updated automatically if importing GPS information. But if necessary, input these parameters manually as follows.

### 5.2.1 Setting for the ship position and the time

The ship position and time can be set manually as follows.

#### ■ Procedure ■

1. From the main menu, touch the [SETUP] → [POS/TIME] buttons.
2. Set the SOURCE menu to MAN to input the ship information manually.
3. After inputting the position and the time, touch the [✓] button to save them.

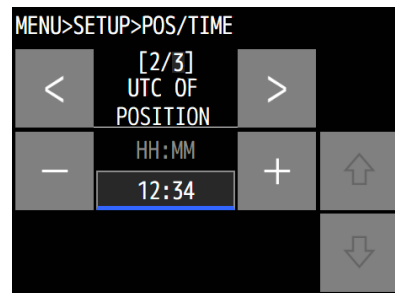
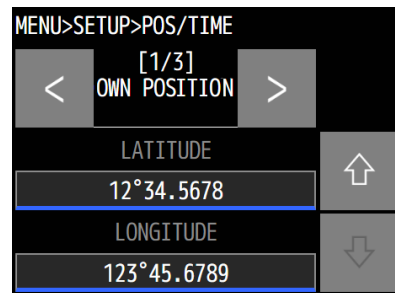
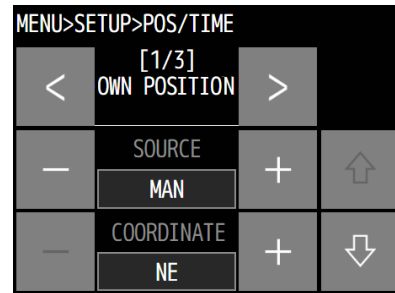

This menu includes the following settings

1. OWN POSITION
  - SOURCE: Select ship position source from below.
    - MAN ..... Manual input
    - GPS ..... External positioning system
    - CLEAR ..... No selection
  - COORDINATE: NE/ NW/ SE/ SW  
LATITUDE/ LONGITUDE
2. UTC OF POSITION
3. STATE DISP
  - DISP TYPE: Select the display type of information on the ship position source from below.
    - NORMAL... Ship position source selected on the SOURCE menu
    - QUALITY .. Positioning system and the type of quality
 (For more details, see "9.4 Peripheral interfaces (1.3)".)

**Note**

- After the position and the time information are input manually, that information is not overwritten with an external device, such as a GPS, automatically.
- If using the external positioning system information after manually inputting data, set the SOURCE menu to "GPS".
- If the position and the time information are not received within 1 minute after powering on, or after 10 minutes elapsed since interrupted, the BAM alert screen and the sound appear. Further, regardless of either manually or automatically if not updated the position and the time within 4 hours after the last entry or only stopping the previous alert, the BAM alert screen and the sound appear again.
- If the position and time are not updated for over 23.5 hours, that information are automatically erased and the error message and the sound appear.

## 5.2.2 Setting priority for the external positioning system

The external positioning system can be setting for priority at the manually as follows.

### ■ Procedure ■

1. From the main menu, touch the [SETUP] → [POS SOURCE] buttons.
2. Set the SOURCE menu to MANUAL.
3. After setting external positioning system to the PRIORITY1~PRIORITY3, touch the [✓] button to save them.

#### Note

The positioning systems other than the GPS, GLONASS or GALILEO are fixed as "OTHER" at the lowest priority (4).

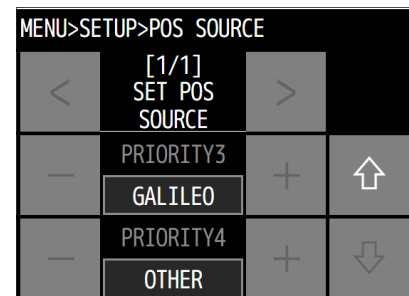
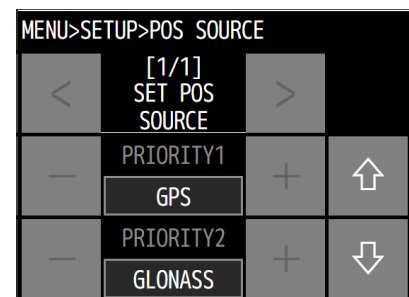
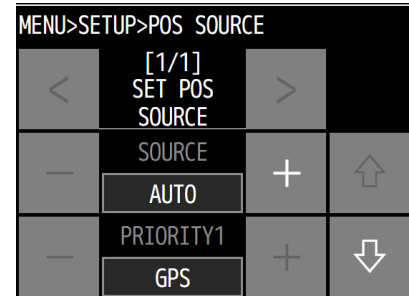

## 5.3 Settings for each control panel

The following describes the procedure regarding individual settings such as visibility adjustment and phone volume for each control panel.

### 5.3.1 LCD adjustment

The LCD conditions for visibility are adjustable as follows.

#### ■ Procedure ■

1. From the main menu, touch the [SETUP]→ [DISP SET] → [LCD ADJ] buttons.

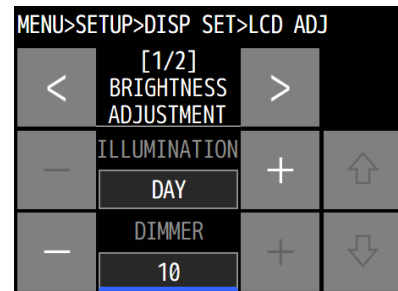

2. After adjusting the LCD conditions, touch the [✓] button to save them.

This menu includes the following settings

#### 1. BRIGHTNESS ADJUSTMENT

ILLUMINATION: Select the kind of range from below.

DAY ···· For daytime use  
(upto max brightness)

DUSK ··· For dusky environment

NIGHT ·· For night use

DIMMER: 0 - 14 steps

#### 2. SCR SAVER SETTINGS

SCR SAVER: ON/OFF

TIME: 1 - 999 seconds

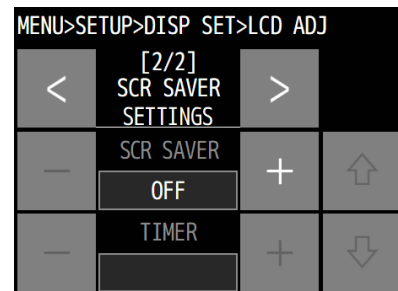

#### Note

When setting the dimmer to 0, the screen is completely turned off. To increase the brightness in this condition, touch the DIM+ button on the right upper corner of the screen.

### 5.3.2 Sound settings

The sound settings such as the click beep are adjustable as follows.

#### ■ Procedure ■

1. From the main menu, touch the [SETUP]→ [DISP SET] → [SOUND] buttons.

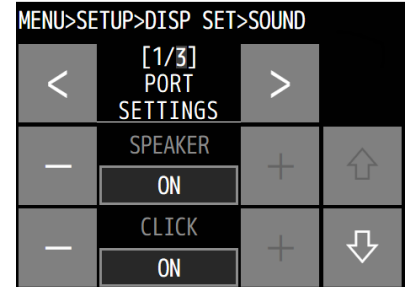

2. After the sound settings, touch the [✓] button to save them.

This menu includes the following settings.

#### 1. PORT SETTINGS

- SPEAKER: Internal loudspeaker ON/OFF
- CLICK: Beep sound ON/OFF
- STD PHONE LV: Handset phone level 1 - 8
- EXT PHONE LV: Ext Handset phone level 1 - 8

#### 2. BEEP SETTING

- NOTIF LEV: Notification sound level 1 - 8

#### 3. EQUALIZER

- TYPE: NORMAL ..... No equalizer
- LARGE BASS ... Emphasize the bass largely
- MID BASS ..... Emphasize the bass normally
- SMALL BASS ... Emphasize the bass slightly
- MIDRANGE ..... Emphasize the midrange
- TREBLE ..... Emphasize the treble

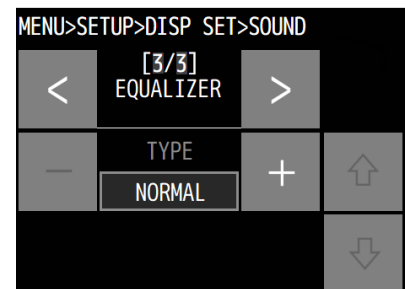
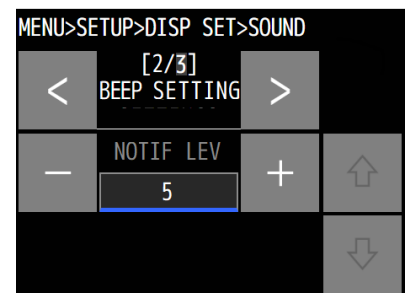

**5.3.3 User key assignment**

The FAVORITE button and FUNCTION buttons can be used as the programmable buttons for the shortcut menus of the desired hierarchical menus, or for the buttons of the special functions.

**■ Procedure ■**

1. From the main menu, touch the [SETUP]→ [DISP SET]→ [KEY ASSIGN] buttons.

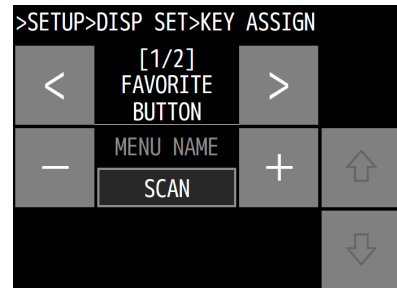

2. To register on the [FAVORITE] button, select the target menu or function from the table below and touch [✓] to save it.

1	CALL	MENU	19	SELF DIAG	MENU
2	RELAY	MENU	20	DSC LOOP	MENU>SELF DIAG
3	DIST-E	MENU	21	ALERT LIST	MENU>MAINT
4	TEST CALL	MENU	22	SYSTEM INFO	MENU>MAINT
5	DSC LOGS	MENU	23	DSC AF	MENU>MAINT
6	SHIPS LIST	MENU>SET UP>ADDR LIST	24	DATE&TIME	MENU>SET UP
7	PROX CHECK	MENU>AIS INFO	25	POS/TIME	MENU>SET UP
8	PLAYBACK	MENU>VOICE FUNC	26	DISP SET	MENU>SET UP
9	PUBLIC ADDR	MENU>VOICE FUNC	27	BT SET	MENU>SET UP
10	INTCOM	MENU>VOICE FUNC	28	ADDR LIST	MENU>SET UP
11	SCAN	MENU>CH OPE	29	DSC OPE	MENU>SET UP
12	DUAL WATCH	MENU>CH OPE	30	AUTO ACK	MENU>SET UP>DSC OPE
13	TRPL WATCH	MENU>CH OPE	31	GROUP ID	MENU>SET UP>DSC OPE
14	CH LIST	MENU>CH OPE>MEMORY CH	32	INACTV T/O	MENU>SET UP>DSC OPE
15	PRIV CH	MENU>CH OPE	33	PRN PROP	MENU>SET UP
16	WEATHER CH	MENU>CH OPE	34	CH MONITOR	Opens the squelch temporarily.
17	REGION	MENU>CH OPE	35	BT SWITCH	Switches on/off the speaker in the BTR-155.
18	CH SQL SET	MENU>CH OPE	36	DAY SCREEN	Reverses black & white on LCD.



- To register on the [FUNC] buttons, select the target menu or function from the table on the previous page and touch [✓] to save it.

FUNC 1	FUNC 2	FUNC 3
FUNC 4	FUNC 5	FUNC 6
FUNC 7	FUNC 8	FUNC 9
FUNC 10	FUNC 11	

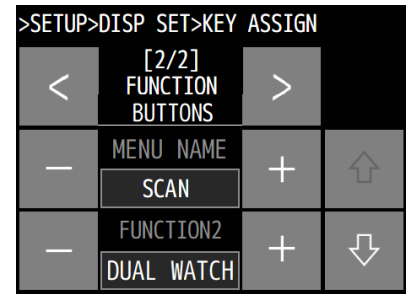

### 5.3.4 Name the device

The main unit and controllers can be named respectively to make identification easier.

#### ■ Procedure ■

- From the main menu, touch the [SETUP]→ [DISP SET] → [UNIT NAME] buttons.

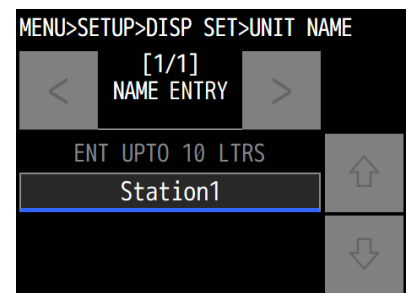

- Touch the blue lined entry field on the NAME ENTRY menu to display the alphanumeric keypad.

- Up to 10 alphanumeric characters available.
- The following characters are available.
  - Alphabet (capital and small letters)
  - Numbers 0 - 9
  - Following signs and space
  - [ ] \_ " # % & ' ( ) ? @ + - / = : ; < >

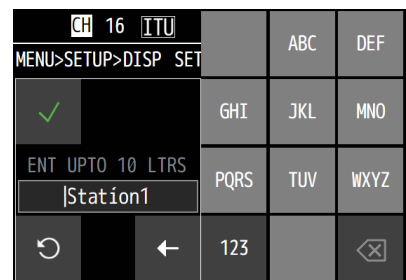

- After inputting the name, touch the [✓] button to save it.

**5.3.5 Menu shutdown timer setting**

If the menu screen is displayed and left without closing, the screen is closed automatically after the specified time, which can be set as follows.

**■ Procedure ■**

1. From the main menu, touch the [SETUP]→ [DISP SET] → [MENU SHTDN] buttons.

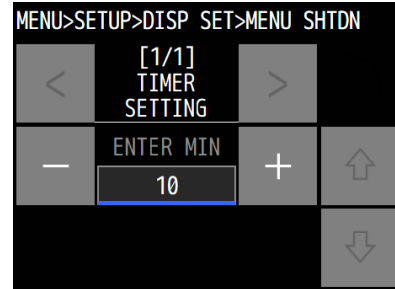

2. After inputting the automatically shutdown time, touch [✓] to save it.

- The timer can be set within 01 -60.
- To disable this function, set 00.

**5.3.6 Setting the handset**

The functions concerned to the handset such as on-hook switch for CH16 setting can be set.

**■ Procedure ■**

1. From the main menu, touch the [SETUP]→ [DISP SET]→ [HANDSET] buttons.

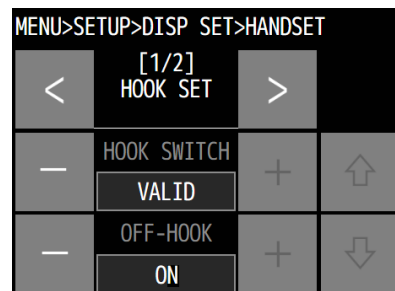

2. After inputting the handset settings, touch [✓] to save it.

This menu includes the following settings.

1. HOOK SET

- HOOK SWITCH: On-hook function setting
- VALID .....CH16 is set when on-hook.
- INVALID .....Channel is not changed when on-hook.

2. PHONE SIDE TONE

- STANDARD: Side tone setting of the standard handset.
- EXTERNAL: Side tone setting of the external handsets (for main unit only).

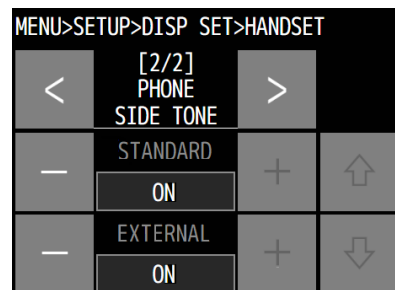

### 5.3.7 Setting the channel area

This menu can select whether the current channel indication area on the status display is used as the ten-key icon or not.

#### ■ Procedure ■

1. From the main menu, touch the [SETUP] → [DISP SET] → [CH AREA] buttons.

Enter the setting as follows.

When using CH area as ten-key icon button: ON

When not using CH area as ten-key icon button: OFF

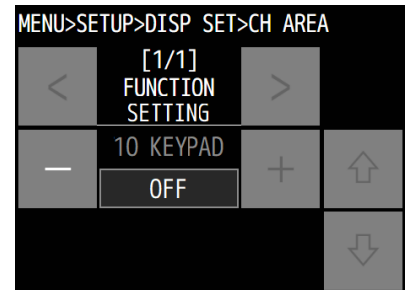

2. After inputting the setting, touch [✓] to save it.

### 5.3.8 Setting the S meter display

This menu can select whether the S meter, which indicates the receiving signal strength on the status display, is used or not.

#### ■ Procedure ■

1. From the main menu, touch the [SETUP] → [DISP SET] → [S METER] buttons.

Enter the setting as follows.

To make the S meter function valid: ON

To make the S meter function invalid: OFF

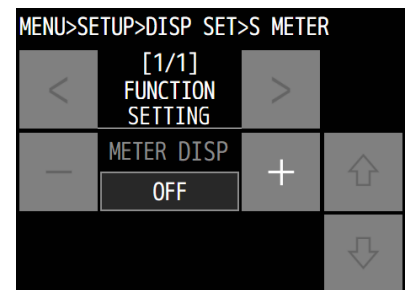

2. After inputting the setting, touch [✓] to save it.

## 5.4 Making contact lists

The following describes the procedure to make contact lists for coast stations or ship stations calls, or for group calls via DSC. Additionally, the PSTN numbers list can be made using the similar procedure.

### (1) Making a new list

#### ■ Procedure ■

- From the main menu, touch the [SETUP] → [ADDR LIST] buttons.

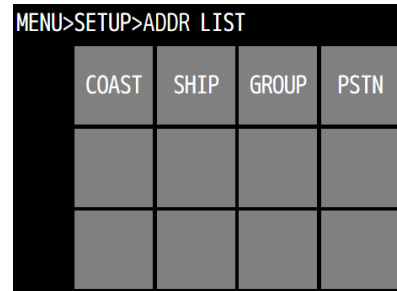

- Touch the type of the station list.

The example at right shows the coast station list. The following is the procedure in the case of the coast station list, but is essentially the same with the case of the ship station list, the group list, or the PSTN number list.

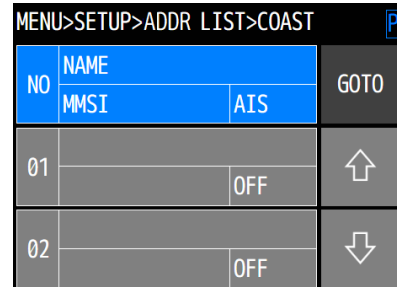

- Touch the line to register the station information.

The setting items are as follows.

- STATE: Set VALID to start registration.
- NAME: Station name (14 characters max)
- MMSI: 9 digits ID
- AIS: Sets the target station to be detected by the PROX CHECK function.

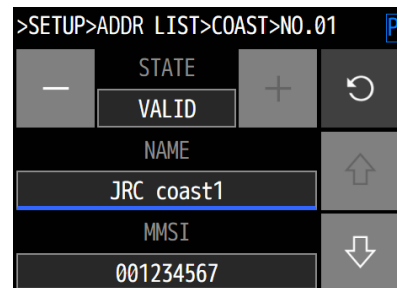

- After the registration is complete, touch the [✓] button to save them.

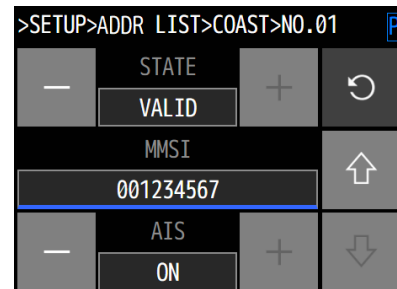

Follow the same procedure above to make the radio station list.

#### Note

- The maximum number is 80 for each of the coast station list, the ship station list, and the PSTN number list, and is 20 for the calling group list.
- On the PSTN number list, the maximum telephone number digit is 16.

## (2) Revising a list

---

### ■ Procedure ■

1. From the main menu, touch the [SETUP] → [ADDR LIST] buttons.

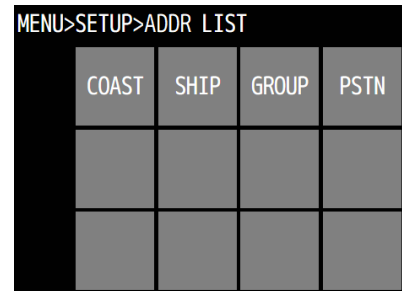

2. Touch the station to be revised and edit the content.  
The example at right shows No.01 coast station.

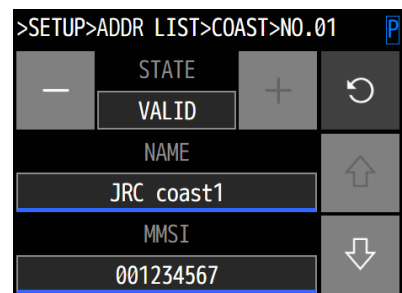

3. After the revising is complete, touch the [✓] button to save them.

#### Note

- To delete the registered station, set the STATE to INVALID.
- To delete the selected type of the station list (coast station, ship station, group, or telephone), touch the [ALL CLEAR] button shown at the bottom of the list.

## 5.5 Advanced settings for DSC

The following describes the procedure for the advanced DSC settings such as automatic acknowledgement, as well as creating a PSTN number list.

### ■ Menu screen ■

From the main menu, touch the [SETUP]→ [DSC OPE] buttons.

The following describes the procedures from this screen.

MENU>SETUP>DSC OPE			
AUTO ACK	RX SOUND	MDCL USE	NEUT USE
EXP MMSI	GROUP ID	INACTV T/O	AUTO CH CHG

### 5.5.1 Automatic acknowledgement

While the automatic acknowledgement is set to ON and if there is no active event, if either one of the individual calls below is received, the acknowledgement is sent automatically.

- Safety test call
  - Safety position request call
  - Routine polling call
  - Individual call requesting communication with invalid channel (\*)
- (\*) In this case, the acknowledgement “unable to comply” is sent.

### ■ Procedure ■

1. Touch the [AUTO ACK] button.

MENU>SETUP>DSC OPE>AUTO ACK			
<	[1/1] FUNCTION SETTINGS	>	P
—	TEST ON	+	↑
—	POSITION RQ OFF	+	↓

2. After inputting the automatic acknowledgement settings, touch [✓] to save them.

The target calls are as follows.

- Safety test call: TEST
- Safety position request call: POSITION RQ
- Routine polling call: POLLING
- Individual call with invalid CH: INDIVIDUAL

MENU>SETUP>DSC OPE>AUTO ACK			
<	[1/1] FUNCTION SETTINGS	>	P
—	POLLING ON	+	↑
—	INDIVIDUAL ON	+	↓

**Note**

- When receiving the safety test, safety position request or routine polling call, the BAM alert screen appears without sounding and the acknowledgement is sent, and then the screen returns to the previous display automatically.
- When receiving the individual calls with invalid channel, "Unable to comply" acknowledgement is sent and the BAM alert screen appears and the BAM alert sound starts (the screen does not return to the previous display automatically).

### 5.5.2 Disabling receiving alerts for routine and safety calls

The aural alert for routine and safety calls can be disabled as follows.

#### ■ Procedure ■

1. Touch [RX SOUND] button.
2. Set the SAF/RTN SND to OFF and touch the [✓] button to save it.

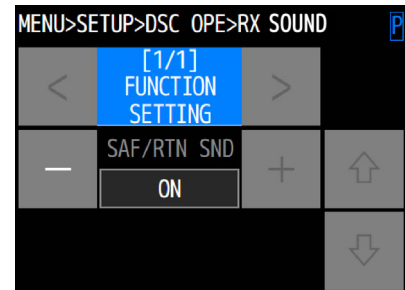

### 5.5.3 Medical/Neutral use setting for urgency calls

The following describes the procedure to set the condition so that an urgency all ships call containing the additional subject of either "Medical transportation" or "Neutral nationality" can be sent. It is useful for the situation when sailing dangerous waters such as in areas of political instability, and needed to inform receivers of the additional information if any of the following apply.

- Own ship is performing medical transportation and protected under the 1949 Geneva Convention.
- Own ship is of neutral nationality in accordance with ITU resolution 18 (Mob-83).

#### ■ Procedure ■

When making a special urgency call, touch the [MDCL USE] button for medical transportation or [NEUT USE] button for neutral nationality and input the setting to ON.

**Note**

This input data returns to the default setting (OFF) if the power is turned off.

**5.5.4 Expanded MMSI registration**

 **CAUTION**



Always set the expanded MMSI in the bridge of the vessel to zero (0). If setting to another value other than zero, DSC calls may not be received.

If there are multiple DSC devices having the same 9-digit MMSI on board a ship, setting the 10th digit of the MMSI number to a non-zero value is available to distinguish them in the case of routine individual calls.

The handling of 10-digit MMSI is as follows.

- When sending a routine individual call, the caller ID (own ship station's MMSI) is 10-digit MMSI.
- When receiving a routine individual call, the DSC having the identical address only treats the message, i.e. mainly the DSC having "0" as the 10th digit of MMSI receives an individual call addressed to the own station.
- When sending an acknowledgement to a received individual call, the address of the call is entered the caller's ID of the individual call as it is, i.e. if the 10th digit of the caller's ID is not "0", the address is 10-digit MMSI automatically.

**■ Procedure ■**

When changing the 10th digit of the MMSI other than zero (0), touch the [EXP MMSI] button to input the value.

**5.5.5 Registering the ship's group ID**

Register the group ID (group ship ID number) for receiving group calls.

**■ Procedure ■**

**1.** Touch the [GROUP ID] button to display the screen as shown at right.

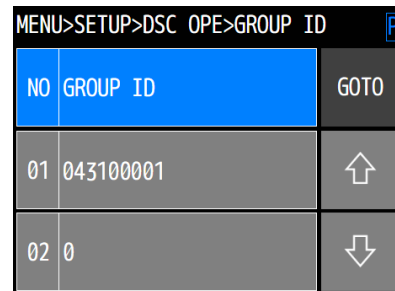

**2.** Touch the line to register the group ID.

Up to 20 groups, set the item below.

STATE: Set VALID to start registration.

MMSI: 9 digits ID



- To delete the group ID, set the STATE to INVALID.
- To delete every group ID, touch the [ALL CLEAR] button shown at the bottom of the list.

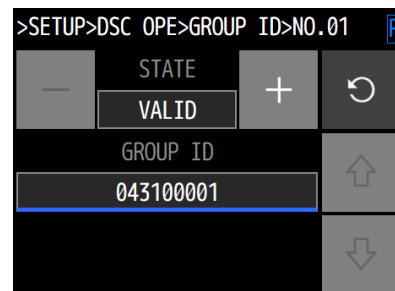

**3.** After the registration is complete, touch the [✓] button to save them.



### 5.5.6 Setting the inactivity timeout timer

If a call event is left without operation for a while, the call event is automatically ended after the setting time is elapsed. The inactivity timeout timer can be set as follows.

#### ■ Procedure ■

1. Touch the [INACTV T/O] button to display the screen as shown at right.

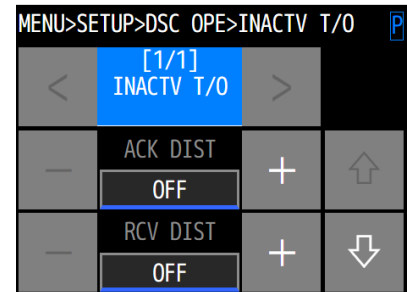

2. Change the timer settings as appropriate.

This menu includes the following settings. Furthermore, set to OFF if making the inactivity timeout timer invalid

- ACK DIST: The acknowledged distress alert events (00 (OFF) - 60 minutes)
- RCV DIST: The distress events of other ships (00 (OFF) - 60 minutes)
- NON DIST: Routine, safety and urgency events (00 (OFF) - 60 minutes)
- OTHER COMM: Communications without using DSC. (10 - 600 seconds, No off-setting)

3. After the settings is complete, touch the [✓] button to save them.

### 5.5.7 Setting the Auto channel change

This menu sets the channel changing mode when receiving DSC calls to multiple stations.

#### ■ Procedure ■

1. Touch the [AUTO CH CHG] button to display the screen as shown at right.
2. When receiving a DSC call to multiple stations, if setting the channel changing mode so that the work channel is set to the specified one automatically, set this menu to ON. Otherwise if setting the channel manually in such a situation, set this menu to OFF.

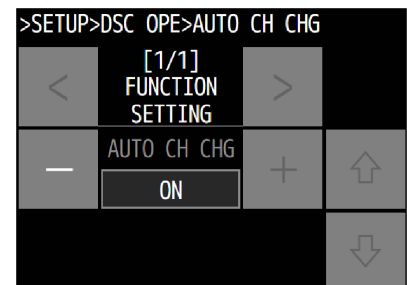

- Note**
- If AUTO CH CHG is set to OFF, the popup screen as shown at right is displayed when receiving DSC calls to multiple stations. Then if [ACCEPT] is selected, the specified work channel is set.
  - When receiving DSC calls during menu screen operation, the popup screen as shown at right is displayed. Then if [DSC OPE] is selected, the specified work channel is set.

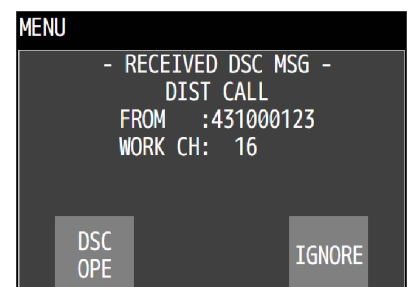
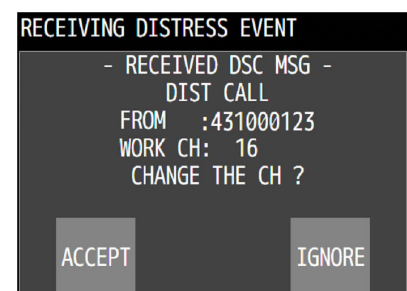

## 5.6 Other settings

The following describes optional function settings about AIS information, printer property, controller connection, and waypoints registration for the block channel function.

### 5.6.1 Enabling the AIS function

When connecting the AIS to use the information for such as a DSC call, set the import condition to ON as follows.

#### ■ Procedure ■

1. From the main menu, touch the [SETUP]→ [AIS FUNC] buttons to display the screen as shown at right.

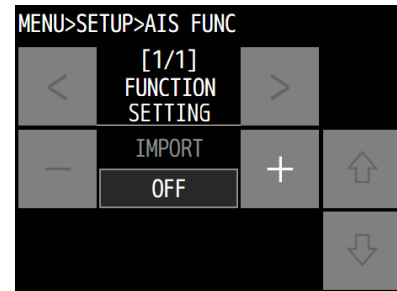

2. After setting the IMPORT to ON, touch the [✓] button to save it.

### 5.6.2 Setting printer property

When connecting the printers, configure the conditions as follows.

#### ■ Procedure ■

1. From the main menu, touch the [SETUP]→ [PRN PROP] buttons to display the screen as shown at right.

This menu includes the following settings.

- STATE: Printer use (ON) or not (OFF)
- IP ADDRESS: Change the value if appropriate.  
(172.016.060.181 as factory default setting)
- PORT: Change the value if appropriate.  
(09100 as factory default setting)
- DATA OUT: Printout setting of DSC messages  
(AUTO or MANUAL)
- DIRECTION: Printout direction  
(UPRIGHT or INVERT)

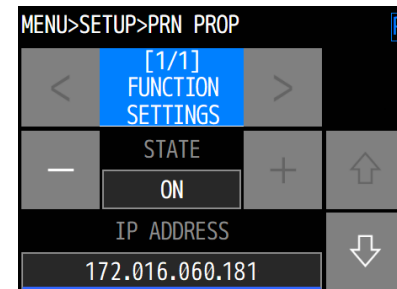

2. After the setting is complete, touch the [✓] button to save them.

### 5.6.3 Setting of the controller start

When the external power is supplied to the main unit, the main unit is turned on automatically. This menu sets whether the controller is turned on at once with the main unit then, or the controller returns to the previous state of just before turned off.

#### ■ Procedure ■

1. From the main menu, touch the [SETUP] → [DISP SET] → [CTLR START] buttons.

Enter the setting as follows.

- To turn on with the main unit: ON
- To return to the previous state: OFF

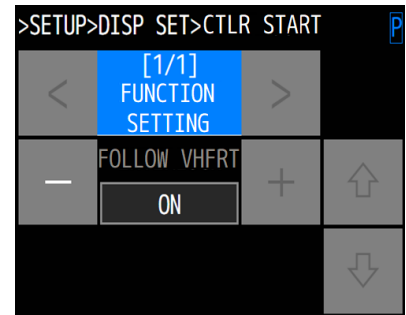

2. After the setting is complete, touch the [✓] button to save it.

#### Note

This function is the individual for the controller and cannot be displayed on the main unit.

**5.6.4 Registering waypoints for block channel function**

As mentioned in the section 4.6.6, the block channel function is implemented so that a VHF channel specified for each area of rivers can be checked and changed easily. To use this function, register waypoints according to the following procedure.

- NOTE) - If the concerned menus are not appeared, it would be necessary to set the BCF MODE to Valid in the maintenance menu. (In the case, please contact us or our agency.)
- If the concerned menus are shown by grey colored letters and inaccessible, check if a positioning device such as GPS is connected and the ship's position data on the river are input normally.
  - The waypoint means “channel changing area” and are defined by the following data.

Item	Area* name	Coordinate	Center latitude/longitude	Radius range	CH region	Blk name &CH (1)	Blk name &CH (2)	Blk name &CH (3)
Default	(Blank)	NE	(Blank)	100 m	IWW	(Blank)	(Blank)	(Blank)

(\*) The word “Area” means a channel changing area (waypoint) where the VHF channel is changed to the new one for the next block area.

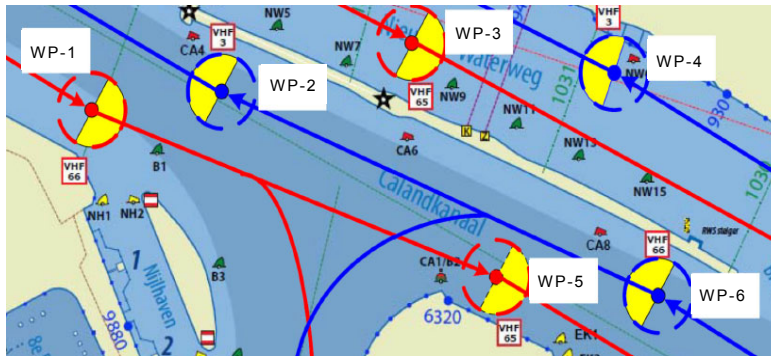

Example of waypoints (WP) image

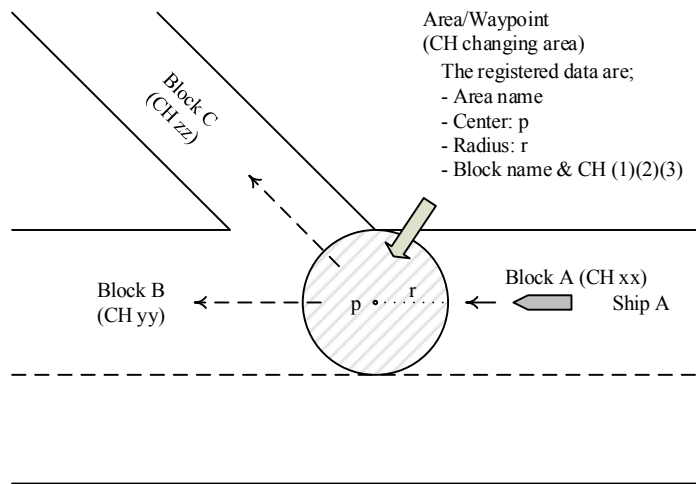

Registration image

There are two methods to register the waypoints, both by using the setup menu on the panel or by using Google Chrome web browser, as follows.

## (1) Register via the setup menu

### ■ Procedure ■

- From the main menu, touch [SETUP] → [BLOCK CH] buttons to display the screen as shown at right.

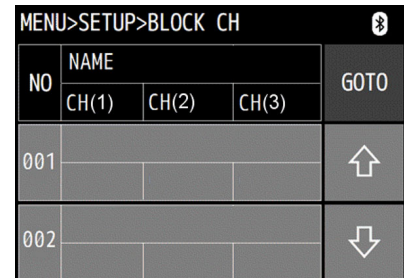

- Touch the line to register the waypoint information.

The setting items are as follows.

- REGISTER: Set VALID to start registration.
- AREA NAME: Waypoint name (14 letters max.)
- COORDINATE: NE/ NW/ SE/ SW
- CENTER LATITUDE: Center lat of the waypoint circle
- CENTER LONGITUDE: Center lon of the waypoint circle
- RANGE (M): Radius of the waypoint circle
- REGION: IWW/ ITU/ USA/ Canada
- BLK NAME (x): Block name of river bordering on the waypoint circle (15 letters max.)
- CHANNEL (x): VHF ch numbers corresponding to BLK NAME (x)

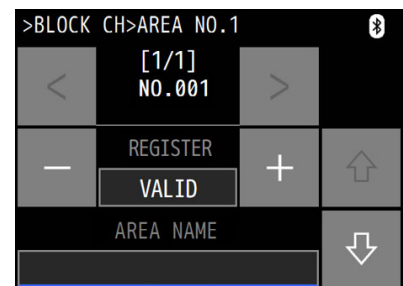

#### Note

- Upto 3 pairs of BLK NAME and CHANNEL are available to register. Note that if only one channel is registered, a popup is appeared for confirmation as shown at right.
- The waypoint including only one pair of BLK NAME and CHANNEL is recognized as the ending point, i.e., the ship crosses into this waypoint and the registered channel is as same as the one which is set to the JHS-800S, the waypoint is recognized as the ending point and the block channel function is finished automatically.

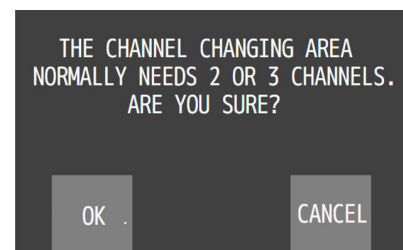

- After the setting is complete, touch the [✓] button to save them.
- Repeat the steps 2 and 3 above to register every required waypoint.

## (2) Register via the web browser

---

### **WARNING**



If using a web browser on the personal computer to register waypoints for the block channel function, do it only while the radio communication is not needed. The main unit shows BROWSING MODE and is not available after starting the registration.

### ■ Procedure ■

1. Connect a PC to the JHS-800S via LAN cable.

2. Change the PC IP address to "172.16.60.1".

Note) Be careful not to forget the PC original IP address.

3. Launch the Google chrome web browser and input the following URL in the address bar.  
[http://172.16.60.xxx/vhf\\_html/login.html](http://172.16.60.xxx/vhf_html/login.html)

Note) xxx: Individual 4th octet (ex. 194) of the JHS-800S

4. Input a password "0000" on the following Login screen, and click the Login button to start the VHF Service Menu.

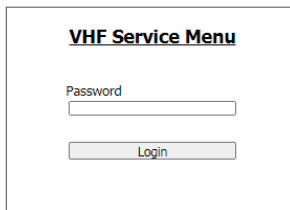

5. Click the Block Channel Function (BCF) menu arrowed at the following figure to start downloading the BCF database registered in the JHS-800S.



6. After a few tens of seconds later, the downloading of the first 20 waypoints is finished and the BCF registration list is appeared as follows, which is the factory default state.

NOTE) The downloading is performed in groups of 20 waypoints (except the group of 19 waypoints for the last No. 981 - 999).

**JRC VHF Service Menu**

Menu  
Block channel function

**Block channel function**

No.001-020

No.	Register	Area Name	Center Latitude	Center Longitude	Range(M)	BLK Name(1)	Channel(1)	BLK Name(2)	Channel(2)	BLK Name(3)	Channel(3)
001	Invalid										
002	Invalid										
003	Invalid										
004	Invalid										
005	Invalid										
006	Invalid										
007	Invalid										
008	Invalid										
009	Invalid										
010	Invalid										
011	Invalid										
012	Invalid										
013	Invalid										
014	Invalid										
015	Invalid										
016	Invalid										
017	Invalid										
018	Invalid										
019	Invalid										
020	Invalid										

Restore Backup All Clear

7. Click a line on the list to register the waypoint information and firstly set the Register to Valid to start registration.

(No.001)

Register: Valid

Area Name:

Center Latitude:  °  .  N

Center Longitude:  °  .  E

Range(M): 0100

Region: IWW

BLK Name(1):

Channel(1):

Set

8. Register the required waypoint data. Then after the waypoint registration is complete, click the Set button on the dialog box to finish and save data in the JHS-800S.

NOTE) The parameters are as same as the case of the setup menu mentioned above.

9. Repeat the steps 7 and 8 above to register every required waypoint.

10. After the waypoint registrations (999 waypoints max.) are complete, close the web browser window and restart the JHS-800S.

## Settings & Registrations

Furthermore, the Backup, Restore and All Clear buttons on the browser screen are available as follows.

- Backup: Saves the registration list in the PC folder (depending on the PC) with the name "VHF\_BCFsetting.csv " to reuse by Restore button.  
NOTE) After the backup is complete, changing the filename to another one to safely save is recommended.
- Restore: Registers waypoints data to the same or another JHS-800S using the backup file made by the Backup button mentioned above.
- All Clear: Erases all of the registered data.



## 6. MAINTENANCE & INSPECTION

The performance and lifetime of the equipment depend on the appropriate maintenance. This chapter describes the maintenance and inspection, self diagnosis, and outline of adjustment.

### 6.1 General maintenance & inspection

In order to operate the equipment under optimum conditions, it is vital to perform regular inspections and also, to keep accurate records. Inspections enable problems to be identified before they become major malfunctions.

The following inspections should be made regularly.

No.	Inspection items	Procedure
1	Antenna system	Check that antennas and the connectors are secure.
2	Squelch operation	On the control panel with access right, turn the SQ control fully counterclockwise and check if the noise is output from the speaker. And also check if the noise is suppressed by turning the SQ control clockwise.
3	Receiver condition checked by speaker output.	Check if the voice level and noise level are abnormally loud or soft.
4	Handset PTT switch	Press PTT to check if the <b>TX</b> mark is displayed on the screen and the unit transmits immediately.
5	Transmission and reception check by performing radio communication.	Check if the normal radiotelephony communication is possible.

## 6.2 Self diagnosis inspection

The following describes the procedure to perform inspections through self-diagnosis.

### ■ Procedure ■

- From the main menu, touch the [SELF DIAG] button to display the screen as shown at right.

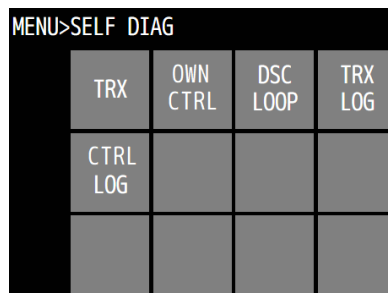

- Select either button of [TRX] for the RF circuit, [OWN CTRL] for the control circuit of the unit now operating, or [DSC LOOP] for DSC TX-RX loop.

The example at right shows TRX checking screen.

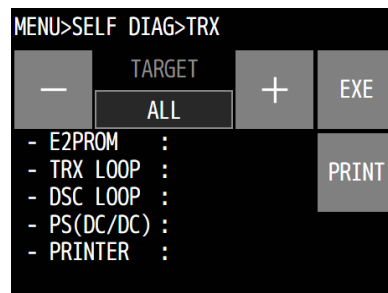

- Select the target test item and touch the [EXE] button to start the self diagnosis.

The following test items are available.

- TRX:
- ALL ..... All items
  - E2PROM .....Non-volatile memory
  - TRX LOOP .....TX-RX/WKR RF circuit
  - DSC LOOP .....DSC TX-RX/WKR loop
  - PS(DC/DC).....Internal DC/DC converter
  - PRINTER .....Test printing
- OWN CTRL:
- ALL ..... All items
  - E2PROM .....Non-volatile memory
  - EMMC .....Non-volatile memory
  - SDRAM .....Volatile memory
  - LCD .....Display condition
  - SOUND .....Loudspeaker output

- Note**
- The PRINTER item is available only if the STATE setting (MENU>SETUP>PRN PROP) is ON.
  - To cancel the self-diagnosis during performing, touch the [CANCEL] button.
  - The results of the self-diagnosis are saved as history and the latest 10 logs are referable. (MENU>SELF DIAG>TRX LOG or MENU>SELF DIAG> CTRL LOG)
  - The self-diagnosis test contents and results are as shown below.

Menu	Test Item	Contents	Results
TRX	E2PROM	• EEPROM read/write	OK: Normal NG: Abnormal
	TRX LOOP	• Loop1 (TX-RX) circuit • Loop2 (TX-WKR) circuit	OK: Normal NG-LOOP1: LOOP1 error NG-LOOP2: LOOP2 error NG-LP1/LP2: LOOP1 & 2 error NG-TXVCO: TX VCO error NG-RXVCO: RX VCO error NG-WKRVCO: WKR VCO error NG-TRXVCO: VCO error of TX & RX NG-TX/WKRVCO: VCO error of TX & WKR NG-RX/WKRVCO: VCO error of RX & WKR NG-ALLVCO: All VCO error NG-LP2/RX: RX VCO & loop2 err NG-LP1/WKR: WKR VCO & loop1 err
	DSC LOOP	•DSC Loop1 (TX-WKR) circuit •DSC Loop2 (WKR-RX) circuit	OK: Normal NG-TX/WKR: Loop1 error NG-WKR/RX: Loop2 error NG-ALL: Loop1 & 2 error
	PS (DC/DC)	•DC/DC PWR voltage check	OK: Normal NG: Abnormal
	PRINTER	• Printout test for printer	- A print test sentence is output to the printer, and check the print result. - After the test is complete, "DONE" appears.
OWN CTRL	E2PROM	• EEPROM read/write	OK: Normal NG: Abnormal
	EMMC	• EMMC read/write	OK: Normal NG: Abnormal
	SDRAM	• SDRAM read/write	OK: Normal NG: Abnormal
	LCD	• Screen test	- For visual check of LCD condition, the screen shows several solid color patterns twice in the order of white, black, red, green and blue for 2 sec respectively. - After the test is complete, "DONE" appears.
	SOUND	• Sound test	- Check if a single tone sounds normally. The sound stops in 30 seconds automatically. - After the test is complete, "DONE" appears.

## 6.3 BAM alert indication

The following describes the bridge alert management (BAM) of this equipment.

### 6.3.1. New BAM alert information

If DSC calls reception or any equipment failure is detected, the BAM starts and the screen shows the alert information on both the main unit and the optional controller if connected. The following figure shows the example of when the LAN printer error occurs.

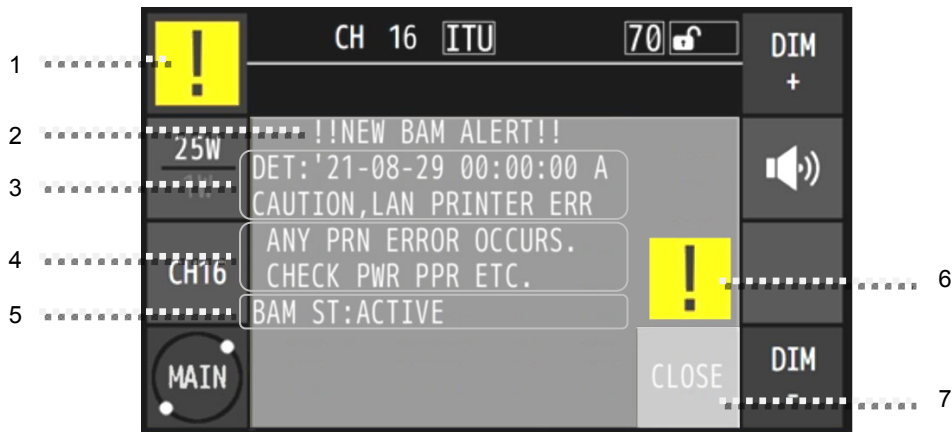

1	Indicates the BAM alert state icon when a DSC call is received or any malfunction occurs, and also by touching this button, indicates the BAM alert list. Additionally when there are multiple alerts simultaneously, only the highest priority alert icon is indicated.
2	Indicates that a new BAM alert occurs.
3	Indicates the BAM alert list information, which consists of the below. [Detected date and time] [BAM alert state*] [Alert priority] [Alert title] (*) There are warning and caution alert states which are indicated by one letter code with the dedicated icon respectively as follows. Warning) V: Active - unacknowledged (The flashing icon  is appeared.) S: Active - silenced (The flashing icon  is appeared.) U: Rectified - unacknowledged (The flashing icon  is appeared.) A: Active - acknowledged (The icon  is appeared.) O: Active - responsibility transferred (The icon  is appeared.) Caution) A: Active (The icon  is appeared.) And the BAM alert list mentioned below is sorted by the following priority and state order. Warning (V = S > U > A > O) > Caution (A)
4	Indicates the alert description text of a DSC call information or a proper operational guidance against malfunction.
5	Indicates the BAM alert state on the screen.
6	Indicates the BAM alert state on the screen by an icon.
7	Performs the following functions according to the alert type. 1. In the case of receiving a DSC call, the new BAM alert screen is closed and the DSC receiving screen is displayed. 2. In the case of warning alert for malfunction, the alert is acknowledged and the new BAM alert screen is closed. 3. In the case of caution alert for malfunction, the new BAM alert screen is closed.

**Note**

- In the case of receiving a distress or urgency DSC calls (warning alert), the alert is acknowledged by touching the [STOP] button on the DSC receiving screen.
- After a warning occurs, two-short alert sound is repeated every one min at either the main unit or controller having priority until the alert is acknowledged.
- The description "ALERT HDLG IS DISABLED." is displayed on the new BAM alert screen of the main unit or controller having no priority, and the two-short BAM alert does not sound.

**6.3.2. Displaying the current alert information**

**■ Procedure ■**

1. From the main menu, touch the [MAINT]→ [ALERT LIST] buttons.
  - If any alert is present, the BAM alert list as shown at right is appeared.
  - If no alert is present, "NO DATA" is indicated.
  - This BAM alert list is also appeared by touching the BAM alert icon at the upper left corner of the screen.

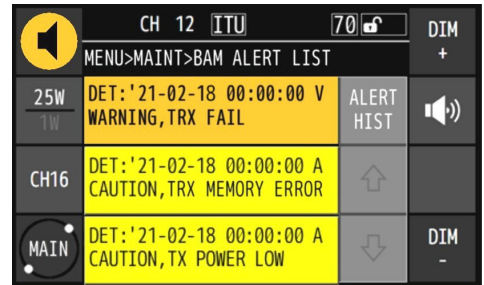

2. To check the alert information in detail, touch the alert indication to display the BAM alert description as shown at right.

In the case of the above example, if touching "TRX MEMORY ERROR" alert, the screen as shown at right is appeared.

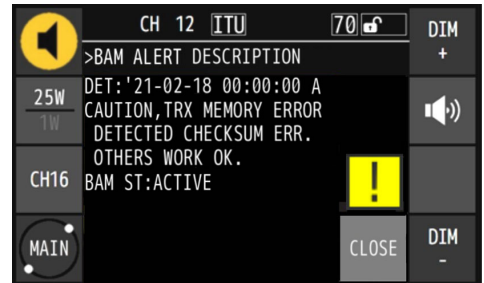

- Note**
- If there are multiple alerts simultaneously, the BAM alert list may be updated when the priority or the state is changed.
  - Scroll using the [↑]/[↓] buttons if there are more than 3 alerts.
  - When TRX PLL unlock occurs, the alert is indicated as the title "TRX FAIL". Additionally, the **UNLOCK** mark is indicated on the screen.
  - When WKR PLL unlock occurs, the **70** icon becomes red to show that the CH70 watchkeeping is abnormal.
  - To check old alerts that occurred in the past, touch [ALERT HIST] button on the BAM ALERT LIST screen. The alert history list is sorted in descending order and up to 100 alert records are available. the alert history is displayed as shown below.

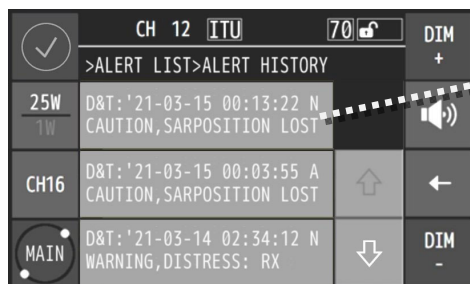

[date and time] [BAM alert state\*]  
 [Alert priority] [Alert title]  
 (\*) For the history, N (normal) is added.

### 6.3.3. Alert list

The following list shows the all BAM alerts and the concerned information.

Alert ID	Title	Description text	Priority	Raising condition	Rectification condition
3122	DISTRESS: RX	DIST-ID:XXXXXXXXX (nature such as FIRE),CH16	Warning	Received a DSC distress alert.	Inform the captain and keep watch on channel 16.
3122	DISTRESS: RELAY	DIST-ID:XXXXXXXXX RLY-ID:XXXXXXXXX,CH16	Warning	Received a DSC distress relay call.	Inform the captain and keep watch on channel 16.
3122	URGENCY: RX	RXID:XXXXXXXXX INDIVIDUAL,CH16	Warning	Received a DSC urgency individual call.	Acknowledge the call and comm via radiotelephone.
3122	URGENCY: RX	RXID:XXXXXXXXX ALL SHIPS,CH16	Warning	Received a DSC urgency all ships call.	Keep watch on channel 16.
3123	SAFETY: COM	RXID:XXXXXXXXX INDIVIDUAL,CH16	Caution	Received a DSC safety individual call.	Acknowledge the call and comm via radiotelephone.
3123	SAFETY: COM	RXID:XXXXXXXXX ALL SHIPS,CH16	Caution	Received a DSC safety all ships call.	Keep watch on channel 16.
3123	SAFETY: POS	RXID:XXXXXXXXX INDIVIDUAL	Caution	Received a DSC safety individual position req call.	Acknowledge the call with the ship position data.
3123	SAFETY: TEST	RXID:XXXXXXXXX INDIVIDUAL	Caution	Received a DSC safety individual test call.	Acknowledge the test call.
3123	ROUTINE: COM	RXID:XXXXXXXXX INDIVIDUAL,CHxx	Caution	Received a DSC routine individual call.	Acknowledge the call and comm via radiotelephone.
3123	ROUTINE: COM	RXID:XXXXXXXXX GROUPID:0YYYYYYYY,CHxx	Caution	Received a DSC routine group call.	Keep watch on the specified channel.
3123	ROUTINE: POLL	RXID:XXXXXXXXX INDIVIDUAL	Caution	Received a DSC routine polling call.	Acknowledge the polling call.
3008	TRX FAIL	DETECTED PLL UNLOCK. USE ANOTHER VHF.	Warning	Detected PLL Unlock in the TX or RX CKT.	<i>Please contact JRC or our agency.</i>
3016	SARPOSITION LOST	NO POSITION DATA. MANUAL ENTRY REQUIRED.	Caution	Receiving no position data from GNSS.	<i>Please contact JRC or our agency.</i>
3013	POSITION 4H OLD	POSITION IS TOO OLD. INPUT NEW POSITION.	Caution	No position input for over 4 hours.	Input the position data manually.
10503	TX POWER LOW	DETECTED HIGH TEMP. TX WORKS AT 1W.	Caution	Detected a high temperature in the main unit	Stop TX, or continue with 1W TX power.
10506	WKR FAIL	DETECTED PLL UNLOCK. TRX WORKS OK.	Caution	Detected PLL Unlock in the DSC WKR.	<i>Please contact JRC or our agency.</i>
10509	TRX MEMORY ERROR	DETECTED CHECKSUM ERR. OTHERS WORK OK.	Caution	Detected a memory error in the main unit.	<i>Please contact JRC or our agency.</i>
10513	CTRL1 COMM ERROR	DETECTED CTRL1 LOST. OTHERS WORK OK.	Caution	Detected no comm from controller No.1.	<i>Please contact JRC or our agency.</i>
10516	CTRL2 COMM ERROR	DETECTED CTRL2 LOST. OTHERS WORK OK.	Caution	Detected no comm from controller No.2.	<i>Please contact JRC or our agency.</i>
10519	CTRL3 COMM ERROR	DETECTED CTRL3 LOST. OTHERS WORK OK.	Caution	Detected no comm from controller No.3.	<i>Please contact JRC or our agency.</i>
10523	CTRL4 COMM ERROR	DETECTED CTRL4 LOST. OTHERS WORK OK.	Caution	Detected no comm from controller No.4.	<i>Please contact JRC or our agency.</i>

Alert ID	Title	Description text	Priority	Raising condition	Rectification condition
10526	LAN PRINTER ERR	ANY PRN ERROR OCCURS. CHECK PWR PPR ETC.	Caution	Detected a LAN printer error.	Check the printer power, paper or the LAN cable.
10529	AIS COMM ERROR	DETECTED AIS LOST. OTHERS WORK OK.	Caution	Detected an AIS comm error.	<i>Please contact JRC or our agency.</i>
10533	NO MMSI	DSC & DISTRESS:INVALID. OTHERS WORK OK.	Caution	Detected no MMSI by not set or lost.	<i>Please contact JRC or our agency.</i>
10536	INTERNAL PS FAIL	DETECTED DC VOLT ERR. CHECK PWR SOURCE.	Caution	Detected a DC/DC power supply error.	<i>Please contact JRC or our agency.</i>
10539	TX VF SIGNAL	DETECTED OUT OF RANGE. TX WORKS OK.	Caution	Detected APC or peripheral CKT error.	<i>Please contact JRC or our agency.</i>
10543	POWER OFF FAIL	PS CKT DOES NOT WORK. TURN OFF EXT PS.	Caution	Detected a PS control error in the main unit.	<i>Turn off the ext. PS, and please contact JRC or our agency.</i>
10546	DMC COMM ERROR	DETECTED DMC LOST. OTHERS WORK OK.	Caution	Detected a DMC LAN comm error.	<i>Please contact JRC or our agency.</i>
10549	CTRL1 MEMORY ERR	DETECTED CHECKSUM ERR. OTHERS WORK OK.	Caution	Detected a memory error in controller No.1.	<i>Please contact JRC or our agency.</i>
10553	CTRL2 MEMORY ERR	DETECTED CHECKSUM ERR. OTHERS WORK OK.	Caution	Detected a memory error in controller No.2.	<i>Please contact JRC or our agency.</i>
10556	CTRL3 MEMORY ERR	DETECTED CHECKSUM ERR. OTHERS WORK OK.	Caution	Detected a memory error in controller No.3.	<i>Please contact JRC or our agency.</i>
10559	CTRL4 MEMORY ERR	DETECTED CHECKSUM ERR. OTHERS WORK OK.	Caution	Detected a memory error in controller No.4.	<i>Please contact JRC or our agency.</i>

**Note**

- All BAM alerts are category B type, where no additional information is needed besides the screen on the equipment.
- The criteria for classification of warning and caution BAM alerts are as follows.
  - Warnings: Conditions or situations which require immediate attention for precautionary reasons, to make the bridge team aware of conditions which are not immediately hazardous, but may become so.
  - Cautions: Awareness of a condition which still requires attention out of the ordinary consideration of the situation or of given information.
- The responsibility transfer state/function requested by the connected CAM system is available for the every BAM warning alert of this equipment.
- Unless acknowledging an warning alert, if the cause of the alert is removed, the warning alert (except DSC reception) may resume and become "Active - rectified" state.
- Regarding the caution alert, if the cause of the alert is removed, the caution alert may resume and become normal.

## 6.4 Checking the setup condition

The system information can be confirmed for use in maintenance and inspection.

### 6.4.1 System information

The following describes the procedure to display such as the ID numbers or peripheral connection conditions.

#### ■ Procedure ■

- From the main menu, touch the [MAINT]→ [SYSTEM INFO] buttons.

MENU>MAINT>SYSTEM INFO		
SELF-ID	:123456789	PRINT
ATIS-ID	:9431011234	
NUM OF CTRLRS	:3	↑
OWN CTRLR ID	:1	
WKR	:VALID	↓
PRIORITY CH	:16	
TX MONITOR	:OFF	
AIS INFO	:RECEIVING	
BAM INFO	:NORMAL	

**Note** The titles and the content are as follows.

Title	Content	Remark
SELF-ID	Own ship's 9-digit identification number (MMSI)	
ATIS-ID	The ATIS number for European inland waterways	
NUM OF CTRLRS	The number of connected controllers Number of main unit and connected controllers	
OWN CTRLR ID	The address number of this controller	
WKR	The setting status to use the watch-keeping receiver	Default setting: Valid
PRIORITY CH	The registered priority channel number	Default setting: CH16
TX MONITOR	The setting status to monitor communications of a controller at the other controllers and the external speaker	Default setting: ON
AIS INFO	The AIS connection status (RECEIVING/DISRUPTED/INVALID)	
BAM INFO	The BAM connection status (NORMAL/CS ERROR/INVALID)	
S/N(RT)	Device's serial number	
S/N(OWN)	Device's serial number (Only for the controller.)	
PRN FUNC	The setting status to use the printer functions	Default setting: OFF
PRN PORT	Printer's port number	
UDP IP ADDR	Device's UDP IP address	
ETH IP ADDR	Device's IP address	
ETH MAC ADDR	Device's MAC address	
BT PAIRING	Names of devices paired with Bluetooth	
BT MAC ADDR	Bluetooth's MAC address	
GROUP-ID xx	The identification number of the group own ship belongs to	xx: 01 - 20



### 6.4.2 Software version

The following describes the procedure to display the software version.

#### ■ Procedure ■

From the main menu, touch the [MAINT]→ [S/W VER] buttons.

The software versions of the RADIOTELEPHONE (JHS-800S) and CONTROLLER (NCM-980) are displayed as shown at right.

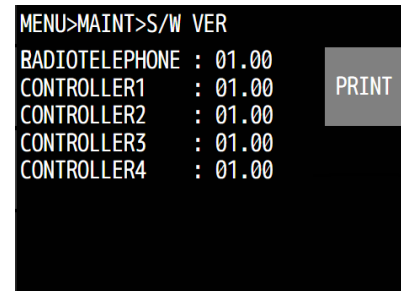

### 6.4.3 Certification mark

The following describes the procedure to display the certification marks.

#### ■ Procedure ■

From the main menu, touch the [MAINT]→ [CERT MARK] buttons.

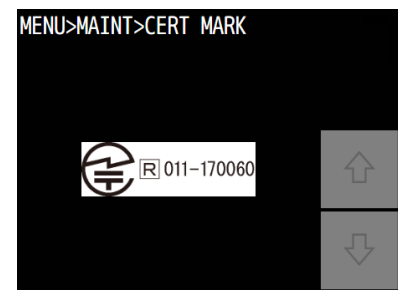

## 6.5 DSC AF inspection

DSC AF modulation frequencies can be checked for periodic inspections etc.

### ■ Procedure ■

1. From the main menu, touch the [MAINT]→ [DSC AF CHECK] buttons to display the screen as shown at right.

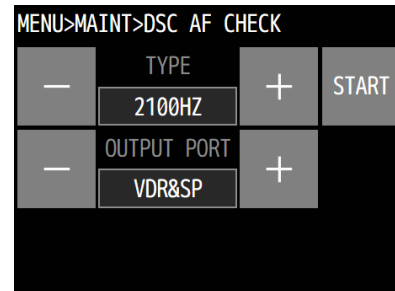

2. Select the TYPE of DSC modulation signal.

The following types are selectable.

- 2100 Hz: Space frequency (B)
- 1300 Hz: Mark frequency (Y)
- DOT: Dot pattern

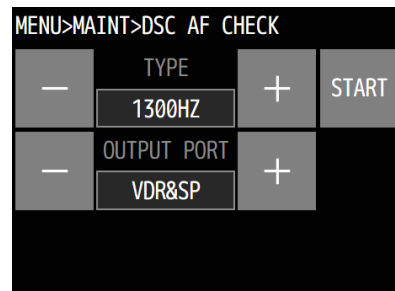

3. Select the OUTPUT PORT of DSC modulation signal.

The following output ports are selectable.

- VDR&SP: VDR output and internal speaker
- VDR&EXHS: VDR output and external handset
- VDR&EXSP: VDR output and external speaker terminal

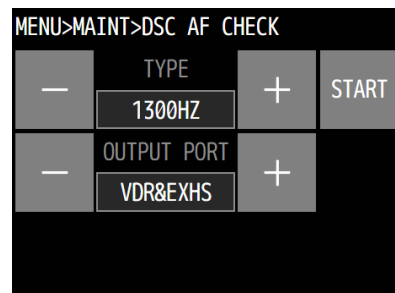

4. Touch the [START] button to output the DSC modulation signal.

The [START] button becomes the [STOP] button.  
To stop the signal, touch the [STOP] button.

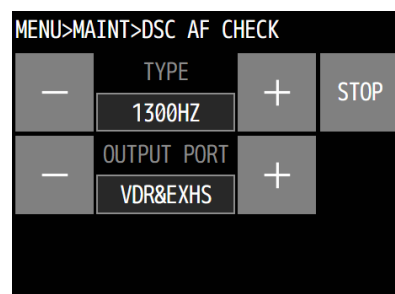

## 6.6 Troubleshooting



### WARNING



If any problem is observed in this unit on usual operation or inspection, contact JRC or our agent. In addition to usual communication, this unit is also used for the distress communication.



Always use the specified fuse when replacing a fuse. Using a different fuse may result in fire or malfunction.



Do not open the equipment to inspect or repair it. Inspection or repairs by anyone other than a specialized technician may result in fire, electrical shock, or malfunction.



If internal inspection or repair is necessary, contact our service center or agents.

### 6.6.1. Procedures for locating malfunctions

- 1) First, check the power supply voltage, fuses, and connectors.
- 2) If there are no problem with the above, use measuring instruments to check for errors.

The following table shows the types of malfunctions classified by measuring instruments and the failure examples. If required to locate the malfunction without qualified service engineers, perform the following No. 1 and 2 only.

No.	Type of Malfunction	Examples
1	Faults requiring no instrument to locate	<ul style="list-style-type: none"> <li>• Blown fuses for the power supply</li> <li>• Faulty contacts</li> <li>• Broken antenna cables</li> <li>• Defective switches and VOL/SQ controls</li> <li>• Other breakages found visually</li> </ul>
2	Malfunctions detectable by the tester and repairable	<ul style="list-style-type: none"> <li>• Abnormal voltage of the power supply</li> <li>• Disconnection of internal wiring</li> </ul>
3	Malfunctions requiring special instrument	<ul style="list-style-type: none"> <li>• Frequency error of crystal oscillators</li> <li>• Decreasing of the transmitting power and the receiving sensitivity</li> <li>• Decreasing of the transmitter modulation</li> <li>• Failure of IC and other parts</li> </ul>

### 6.6.2. Guide to locating faults

Use the following table as a guide to locating the causes of malfunctions in the equipment. Additionally, when contacting JRC or our agency, please provide the malfunction condition.

No.	Symptom	Typical causes
1	After turning on the power supply, nothing appears on the screen.	<ul style="list-style-type: none"> <li>Abnormal power supply voltage</li> <li>Main unit's power supply fuse is blown</li> <li>Defective power supply switch, display circuit, or control circuit</li> <li>Defective controller cable</li> </ul>
2	<b>TX</b> is displayed but no voice is transmitted.	<ul style="list-style-type: none"> <li>Malfunction in the handset</li> <li>Malfunction in the controller cable</li> <li>Malfunction in the AF signal transmission circuit</li> </ul>
3	<b>TX</b> is not displayed, and transmission is impossible.	<ul style="list-style-type: none"> <li>Malfunction in the handset PTT switch</li> <li>Malfunction in the hook detection circuit</li> <li>Malfunction in the transmission circuit</li> </ul>
4	Reception sensitivity is poor.	<ul style="list-style-type: none"> <li>Antenna damage</li> <li>Break or short circuit of antenna cable</li> <li>Faulty contact in antenna connectors</li> </ul>
5	No sound from the speaker when squelch is opened without receiving any RF signal.	<ul style="list-style-type: none"> <li>Malfunction in the speaker</li> <li>Defective SQ control circuit or harness</li> <li>Malfunction in the receiver circuit</li> </ul>
6	Noise outputs from the speaker, but the equipment receives nothing from other stations.	<ul style="list-style-type: none"> <li>Antenna damage</li> <li>Break or short circuit in antenna cable</li> <li>Faulty contact in antenna connectors</li> <li>Malfunction in the receiver</li> </ul>
7	Turning SQ control clockwise does not suppress noise.	<ul style="list-style-type: none"> <li>Malfunction of the SQ control circuit</li> <li>Malfunction in the receiver</li> </ul>

**Note**

The following are not faults.

Symptom	Possible causes	Handling
No response from other station via radiotelephone or DSC call.	No operator in that station, or unavailable to respond due to other duties.	Wait and retry later.
Cannot control the radiotelephone or DSC except the volume control, and dimmer and PWR buttons.	Operations are limited due to no access right (priority).	Touch OPE button to obtain the access right and after that, retry the operation.
Cannot obtain the access right even if touching OPE button on a main unit or controller with no access right when connecting one or more controllers.	The main unit or another controller with higher priority is in use for communicating or performing menu operations.	After operations are complete on the main unit or other controller, retry again.
If the system is left on a screen other than the status display for a while, returns to the status display.	After leaving the specified period, the inactivity timer would be activated and returned to the status display.	Do not leave the system when operating the menu.
Received distress call logs have been erased without operating.	Received distress calls are automatically deleted after 48 hours.	To save the received distress messages, print out them.
When a portable transceiver is brought close to the main unit or the controller, noise comes out from the portable transceiver.	The influence of the radio frequency noise occurs, which is slightly generated from the lighting circuit of the LCD.	Turn off the light for the LCD or keep the portable transceiver at least 1 m away.
The VHF operation on the MFD (ECDIS or Marine radar) screen is not available.	The MFD link is lost for the reason such as the restarting of the main unit	On the MFD screen, restart the VHF Call dialog/ menu.
Incase of the multiple VHF radio onboard, when transmitting from the one VHF radio, the squelch of another VHF radio setting different channel is opened.	The radio interference occurs by the excessive RF input level because the antennas are not mounted directly above or below each other.	Turn the squelch control clockwise so that the squelch is not opened when receiving such an excessive radio wave.

### 6.6.3. Consumables

The following shows consumables. Please contact JRC or our agency to order parts.

Location	Name	Part number	Replacement guide
RP-D10 PRINTER	Printer paper	TP-B10CH	Indicating red mark on the paper edge.

### 6.6.4. Repair units/parts

The repair units and replacement part units are as follows.

#### ● JHS-800S MARINE VHF RADIOTELEPHONE

Name	Unit/Part number	Notes
CONTROL UNIT	CDJ-2800	
RF UNIT	CMN-2800-2	
PS UNIT	CBD-2800	
POWER CABLE	CFS-810	
FUSE	0997015.WXN	15 A, Blade type

#### ● NCM-980 CONTROLLER (option)

Name	Unit/Part number	Notes
CONTROL UNIT	CDJ-9800	
PS UNIT	CBD-9800	
CAN CABLE	CFS-830	

#### ● NBD-965 AC/DC POWER SUPPLY (option)

Name	Unit/Part number	Notes
FUSE	1044	15 A, Blade type

### 6.6.5. Regular replacement parts

The following shows the part to be replaced regularly. Please contact JRC or our agency to order it.

Name	Unit/Part number	Replacement Period
PANEL UNIT	CML-981	LCD backlight: Approx 30,000 to 40,000 hours of continued use at maximum brightness Touch panel: Approx 10 million times (2 times / second)



## 7. AFTER-SALES SERVICE

### ★ Warranty

The **warranty period** is determined by JRC's warranty regulations, but is normally 1 year from the date of purchase. Additionally, the warranty except for the body text is submitted to contractual agreements.

### ★ Repair Part Inventory Period

Parts necessary for proper functioning of this equipment will be kept available for 10 years after product discontinuation.

### ★ When Requesting Repairs

If what appears to be a defect is detected, refer to "6.6 Troubleshooting" to check if the equipment is actually defective.

If the problem is due to a defect, immediately stop use of the system and contact the store at which you purchased the system, or one of our branches.

- **During the warranty period**, if a malfunction occurs with the equipment while in standard usage in accordance with this instruction manual, we or our agencies will repair the malfunction at no charge at the store where the equipment was purchased or another location specified by JRC. If the malfunction occurs due to improper usage, fault, or any external abnormal condition such as fire, pollution, abnormal voltage, natural disaster (ex. thunder storms, earthquake) etc., JRC will repair the equipment for a fee. Furthermore, regardless of the warranty period, orders of consumables will be charged.
- **After the warranty expires**, we will repair the malfunction for a fee, if repair is possible.
- **Please inform us of the following** :
  - ☆ Product name, model name, manufactured date, serial number
  - ☆ As much information as you can provide about the malfunction. (Alert number, whether transmission is possible or not, etc.)
  - ☆ Your company or organization name, address, and phone number

### ★ Periodical Maintenance Recommendation

Depending on usage conditions, with extended use, the performance of this equipment may degrade over time, and externally installed parts such as the antenna may degrade due to vibration, so we recommend periodical maintenance in addition to the standard maintenance.

Please contact the store where you purchased the equipment, or one of our branches, to request periodical maintenance. Periodical maintenance requires a service charge.

If you have any questions regarding after-sales service, please contact the store where you purchased the equipment, or one of our branches.

Refer to the inside of the back cover for contact numbers and locations.

## **8. DISPOSAL**

Observe all rules and regulations of the local authorities when disposing of this equipment.



## 9. SPECIFICATIONS

### 9.1 JHS-800S Marine VHF Radiotelephone

#### ● General Specifications

Transmission frequency	Simplex/semi-duplex: 155.000 MHz - 163.500 MHz
Reception frequency	Simplex/semi-duplex: 155.000 MHz - 163.500 MHz
Number of channels	ITU/USA/Canada/IWW channels: Maximum 65 ch Weather channels: 10 ch Private channels: Maximum 200 ch Memory channels: Maximum 10 ch
Channel spacing	25 kHz
Communication modes	Simplex and semi-duplex press talk system
Type of emission	Radiotelephone communications: F3E (G3E) DSC/ATIS: F2B (G2B)
Antenna impedance	50 $\Omega$ unbalanced
Tx/Rx switching interval	300 ms or less
Channel switching interval	5 s or less
Interface	IEC61162-1 Ed.5 (2016): GPS IEC61162-2 Ed.1 (1998-09): AIS/DIM IEC61162-450 Ed.2 (2018-05)*: GPS/AIS/RMS/DMC/BAM/DIM (* IGMPv3 600 $\Omega$ balanced: VDR 600 $\Omega$ unbalanced: Ext SP
Main controls	DSC call transmitting/receiving, channel settings, TX power settings, squelch/ volume adjustment, screen adjustment
Performance criteria	IMO A.803 (19), A.694 (17), MSC.68 (68), MSC/Circ.862 IEC 60945 Ed.4 (2002-08)
Power supply voltage	24 VDC (21.6 VDC - 31.2 VDC)
Current consumption /Power(24 VDC)	When transmitting at 25 W: Maximum 4.5 A/108 W When receiving: Maximum 1.5 A/36 W
Operating temperature range	-25 $^{\circ}$ C - +55 $^{\circ}$ C
Storage temperature range	-40 $^{\circ}$ C - +80 $^{\circ}$ C
Humidity resistance	No abnormalities after left for 10 hours at +40 $^{\circ}$ C, 93 % RH
Vibration resistance (3 axis)	2 Hz - 5 Hz to 13.2 Hz: Full amplitude $\pm$ 1 mm, $\pm$ 10 % 13.2 Hz to 100 Hz: Maximum acceleration of 7 m/s <sup>2</sup> fixed No abnormality after testing resonance points or at 30 Hz for more than 2 hours.
Continuous operation (Phone)	No abnormalities after operating continuously for 8 hours
Continuous operation (DSC, WKR)	No abnormalities after operating continuously for 24 hours
Category type of the weather resistance	Waterproof handset connection box: Exposed Other units: Protected
Protection rating	IP56 (Dustproof, Waterproof)
Dimensions and mass	240 mm (W) x 96 mm (H) x 136 mm (D) [excluding projections] Approx. 2.1 kg

## Specifications

### ● Transmitter

Antenna output power	12.5 W - 25 W (when reducing: 0.5 W - 1 W)
Deviation of antenna power	Within +20 % and -50 %
Oscillation method	Frequency synthesizer
Modulation method	FM/FSK
Carrier frequency error	$\pm 10 \times 10^{-6}$ or less
Maximum frequency deviation	$\pm 5$ kHz or less
Occupied bandwidth	16 kHz or less
Pre-emphasis characteristics	6 dB/oct within +1 dB, -3 dB
Overall distortion	10 % or less
Adjacent channel power	-70 dB or 0.2 $\mu$ W or less
Unwanted emissions in the out-of-band domain	3.125 $\mu$ W or less
Unwanted emissions in the spurious domain	3.125 $\mu$ W or less
Spurious emissions	9 kHz - 1 GHz: 0.25 $\mu$ W or less 1 GHz - 4 GHz: 0.25 $\mu$ W or less
Residual modulation	-40 dB or less

### ● Receiver

Receiving system	Double superheterodyne
Local oscillation method	Frequency synthesizer
Frequency accuracy	$\pm 10 \times 10^{-6}$ or less
Sensitivity (Phone)	6 dB $\mu$ V or less (SINAD=20 dB)
Sensitivity (DSC)	1 % or lower symbol error rate at 0 dB $\mu$ V
Selectivity	6 dB bandwidth: 12 kHz or more, 70 dB selectivity: 25 kHz or less
Signal-to-Noise ratio	40 dB or more
Audio output variance	3 dB or less
De-emphasis characteristics	6 dB/oct, within +1 dB, -3 dB
Co-channel selectivity	-10 - 0 dB
Adjacent channel selectivity	70 dB or more
Desensitization effect (Phone)	80 dB $\mu$ V or more
Desensitization effect (DSC)	4.47 mV during interference input: 1 % or lower CER
Spurious response (Phone)	80 dB or more
Spurious response (DSC)	4.47 mV during interference input: 1 % or lower CER
Intermodulation characteristics (Phone)	70 dB or more
Intermodulation characteristics (DSC)	2.5 mV during interference input: 1 % or lower CER
Blocking characteristics	90 dB $\mu$ V or more
Radiation	9 kHz - 1 GHz: 2 nW or less, 1 GHz - 4 GHz: 20 nW or less
Squelch mute	-40 dB or less
Squelch open level	+6 dB $\mu$ V or less
Overall distortion	10 % or less

● CH70 Watchkeeping Receiver

Receiving frequency	156.525 MHz (CH70)
Receiving system	Double superheterodyne
Local oscillation method	Frequency synthesizer
Local oscillation freq. variance	$\pm 10 \times 10^{-6}$ or less
Sensitivity	1 % or lower symbol error rate at 0dB $\mu$ V
Selectivity	6 dB bandwidth: 12 kHz or more, 70 dB selectivity: 25 kHz or less
De-emphasis characteristics	6 dB/oct, within +1 dB, -3 dB
Co-channel selectivity	SER is less than $10^{-2}$ when -8 dB of interference is added
Adjacent channel selectivity	4.47 mV during interference input; 1 % or lower CER
Desensitization effect	4.47 mV during interference input; 1 % or lower CER
Spurious response	4.47 mV during interference input; 1 % or lower CER
Intermodulation characteristics	2.5 mV during interference input; 1 % or lower CER
Blocking characteristics	BER is less than $10^{-2}$ when 90 dB of interference is added
Radiation	9 kHz - 2 GHz: 2 nW or less

● DSC/ATIS Modem

Modulation rate	1200 baud (within 600 Hz $\pm$ 30 ppm)
Modulation method	FSK
Modulation index	DSC: 2.0 $\pm$ 10 % or less ATIS: 1.0 $\pm$ 10 % or less:
Mark frequency (Y)	1300 Hz $\pm$ 10 Hz or less
Space frequency (B)	2100 Hz $\pm$ 10 Hz or less
DSC protocol	ITU-R Recommendation M.493-14 (Class A)
DSC operation standards	ITU-R Recommendation M.541-9, M.689-2, M.821-1, M.1080-0
ATIS protocol, standards	ETSI EN 300 698 V2.2.1

● Display control panel

Microphone input impedance	2.2 k $\Omega$ balanced (NQW-980 use)
Standard modulation input	-40 dBm
Audio output	Internal loudspeaker (4 $\Omega$ ): Max. 6 W or more Handset phone (150 $\Omega$ ): Max. 1 mW or more
LCD	5-inch TFT color, 800x480 pixels, LED backlight, Maximum brightness 1000 cd/m <sup>2</sup>
Operation buttons	Touch panel, power button, DISTRESS button, volume control, SQ control

## 9.2 Channel assignment tables

(1) ITU Channels (ITU-RR Appendix18)

CH	TX (MHz)	RX (MHz)	Simplex	Semi-duplex	Notes
01	156.050	160.650		●	
02	156.100	160.700		●	
03	156.150	160.750		●	
04	156.200	160.800		●	
05	156.250	160.850		●	
06	156.300	156.300	●		For inter-ship communications
07	156.350	160.950		●	
08	156.400	156.400	●		For inter-ship communications
09	156.450	156.450	●		For inter-ship communications
10	156.500	156.500	●		For inter-ship communications
11	156.550	156.550	●		
12	156.600	156.600	●		
13	156.650	156.650	●		For inter-ship communications
14	156.700	156.700	●		
15	156.750	156.750	●		For inter-ship communications
16	156.800	156.800	●		Distress, Safety and Calling
17	156.850	156.850	●		For inter-ship communications
18	156.900	161.500		●	
19	156.950	161.550		●	
1019	156.950	156.950	●		
2019		161.550	●		Transmission prohibited
20	157.000	161.600		●	
1020	157.000	157.000	●		
2020		161.600	●		Transmission prohibited
21	157.050	161.650		●	Digital data comm has priority.
22	157.100	161.700		●	Digital data comm has priority.
23	157.150	161.750		●	Digital data comm has priority.
24	157.200	161.800		●	Digital data comm has priority.
25	157.250	161.850		●	Digital data comm has priority.
26	157.300	161.900		●	Digital data comm has priority.
1027	157.350	157.350	●		
1028	157.400	157.400	●		
60	156.025	160.625		●	
61	156.075	160.675		●	
62	156.125	160.725		●	
63	156.175	160.775		●	
64	156.225	160.825		●	
65	156.275	160.875		●	
66	156.325	160.925		●	
67	156.375	156.375	●		
68	156.425	156.425	●		
69	156.475	156.475	●		For inter-ship communications
70	156.525	156.525	●		For DSC operation only
71	156.575	156.575	●		
72	156.625	156.625	●		For inter-ship communications
73	156.675	156.675	●		
74	156.725	156.725	●		
75	156.775	156.775	●		Fixed at 1W
76	156.825	156.825	●		Fixed at 1W
77	156.875	156.875	●		For inter-ship communications
78	156.925	161.525		●	
1078	156.925	156.925	●		
2078		161.525	●		Transmission prohibited
79	156.975	161.575		●	
1079	156.975	156.975	●		
2079		161.575	●		Transmission prohibited
80	157.025	161.625		●	Digital data comm has priority.
81	157.075	161.675		●	Digital data comm has priority.
82	157.125	161.725		●	Digital data comm has priority.
83	157.175	161.775		●	Digital data comm has priority.
84	157.225	161.825		●	Digital data comm has priority.
85	157.275	161.875		●	Digital data comm has priority.
86	157.325	161.925		●	Digital data comm has priority.
87	157.375	157.375	●		
88	157.425	157.425	●		

## (2) USA Channels (FCC 47 CFR Part 80: 80.215, 80.371 and 80.373)

CH	TX (MHz)	RX (MHz)	Simplex	Semi-duplex	Notes
01A	156.050	156.050	●		
02					Unused
03					Unused
04					Unused
05A	156.250	156.250	●		
06	156.300	156.300	●		For inter-ship communications
07A	156.350	156.350	●		
08	156.400	156.400	●		For inter-ship communications
09	156.450	156.450	●		
10	156.500	156.500	●		
11	156.550	156.550	●		
12	156.600	156.600	●		
13	156.650	156.650	●		1W default (momentary 25W)
14	156.700	156.700	●		
15		156.750			Transmission prohibited
16	156.800	156.800	●		Distress, Safety and Calling
17	156.850	156.850	●		
18A	156.900	156.900	●		
19A	156.950	156.950	●		
20	157.000	161.600		●	
20A	157.000	157.000	●		For inter-ship communications
21A	157.050	157.050	●		For USCG (General use prohibited)
22A	157.100	157.100	●		
23A	157.150	157.150	●		For USCG (General use prohibited)
24	157.200	161.800		●	
25	157.250	161.850		●	
26	157.300	161.900		●	
27	157.350	161.950		●	
28	157.400	162.000		●	
60					Unused
61					Unused
62					Unused
63A	156.175	156.175	●		
64					Unused
65A	156.275	156.275	●		
66A	156.325	156.325	●		
67	156.375	156.375	●		1W default (momentary 25W)
68	156.425	156.425	●		
69	156.475	156.475	●		
70	156.525	156.525	●		For DSC operation only
71	156.575	156.575	●		
72	156.625	156.625	●		For inter-ship communications
73	156.675	156.675	●		
74	156.725	156.725	●		
75	156.775	156.775	●		Fixed at 1W
76	156.825	156.825	●		Fixed at 1W
77	156.875	156.875	●		For inter-ship communications, fixed at 1W
78A	156.925	156.925	●		
79A	156.975	156.975	●		
80A	157.025	157.025	●		
81A	157.075	157.075	●		General use prohibited
82A	157.125	157.125	●		General use prohibited
83A	157.175	157.175	●		For USCG (General use prohibited)
84	157.225	161.825		●	
85	157.275	161.875		●	
86	157.325	161.925		●	
87	157.375	161.975		●	
88	157.425	157.425	●		For inter-ship communications

**Note**

The "Unused" channels listed above cannot be set while in the USA channel mode.

Specifications

(3) Canada Channels (INDUSTRY CANADA RBR-2)

CH	TX (MHz)	RX (MHz)	Simplex	Semi-duplex	Notes
01	156.050	160.650		●	
02	156.100	160.700		●	
03	156.150	160.750		●	
04A	156.200	156.200	●		For CCG (General use prohibited)
05A	156.250	156.250	●		
06	156.300	156.300	●		
07A	156.350	156.350	●		
08	156.400	156.400	●		
09	156.450	156.450	●		
10	156.500	156.500	●		
11	156.550	156.550	●		
12	156.600	156.600	●		
13	156.650	156.650	●		
14	156.700	156.700	●		
15	156.750	156.750	●		Fixed at 1W
16	156.800	156.800	●		Distress, Safety and Calling
17	156.850	156.850	●		Fixed at 1W
18A	156.900	156.900	●		
19A	156.950	156.950	●		For CCG (General use prohibited)
20	157.000	161.600		●	Fixed at 1W
21A	157.050	157.050	●		For CCG (General use prohibited)
21B		161.650	●		
22A	157.100	157.100	●		General use prohibited
23	157.150	161.750		●	
23B		161.750	●		
24	157.200	161.800		●	
25	157.250	161.850		●	
25B		161.850	●		
26	157.300	161.900		●	
27	157.350	161.950		●	
28	157.400	162.000		●	
28B		162.000	●		
60	156.025	160.625		●	
61A	156.075	156.075	●		For CCG (General use prohibited)
62A	156.125	156.125	●		For CCG (General use prohibited)
63A	156.175	156.175	●		
64	156.225	160.825		●	
64A	156.225	156.225	●		
65A	156.275	156.275	●		
66A	156.325	156.325	●		
67	156.375	156.375	●		
68	156.425	156.425	●		
69	156.475	156.475	●		
70	156.525	156.525	●		For DSC operation only
71	156.575	156.575	●		
72	156.625	156.625	●		
73	156.675	156.675	●		
74	156.725	156.725	●		
75	156.775	156.775	●		Fixed at 1W
76	156.825	156.825	●		Fixed at 1W
77	156.875	156.875	●		
78A	156.925	156.925	●		
79A	156.975	156.975	●		
80A	157.025	157.025	●		
81A	157.075	157.075	●		For CCG (General use prohibited)
82A	157.125	157.125	●		For CCG (General use prohibited)
83A	157.175	157.175	●		For CCG (General use prohibited)
83B		161.775	●		
84	157.225	161.825		●	
85	157.275	161.875		●	
86	157.325	161.925		●	
87	157.375	157.375	●		
88	157.425	157.425	●		

## (4) IWW Channels (ETSI EN 300 698 V2.2.1)

CH	TX (MHz)	RX (MHz)	Simplex	Semi-duplex	Notes
01	156.050	160.650		●	
02	156.100	160.700		●	
03	156.150	160.750		●	
04	156.200	160.800		●	
05	156.250	160.850		●	
06	156.300	156.300	●		For inter-ship communications, fixed at 1W
07	156.350	160.950		●	
08	156.400	156.400	●		For inter-ship communications, fixed at 1W
09	156.450	156.450	●		
10	156.500	156.500	●		Fixed at 1W
11	156.550	156.550	●		Fixed at 1W
12	156.600	156.600	●		Fixed at 1W
13	156.650	156.650	●		Fixed at 1W
14	156.700	156.700	●		Fixed at 1W
15	156.750	156.750	●		Fixed at 1W
16	156.800	156.800	●		Distress, Safety and Calling
17	156.850	156.850	●		Fixed at 1W
18	156.900	161.500		●	
19	156.950	161.550		●	
1019	156.950	156.950	●		
2019		161.550	●		Transmission prohibited
20	157.000	161.600		●	
1020	157.000	157.000	●		
2020		161.600	●		Transmission prohibited
21	157.050	161.650		●	Digital data comm has priority.
22	157.100	161.700		●	Digital data comm has priority.
23	157.150	161.750		●	Digital data comm has priority.
24	157.200	161.800		●	Digital data comm has priority.
25	157.250	161.850		●	Digital data comm has priority.
26	157.300	161.900		●	Digital data comm has priority.
1027	157.350	157.350	●		
1028	157.400	157.400	●		
60	156.025	160.625		●	
61	156.075	160.675		●	
62	156.125	160.725		●	
63	156.175	160.775		●	
64	156.225	160.825		●	
65	156.275	160.875		●	
66	156.325	160.925		●	
67	156.375	156.375	●		
68	156.425	156.425	●		
69	156.475	156.475	●		
70	156.525	156.525	●		For DSC operation only
71	156.575	156.575	●		Fixed at 1W
72	156.625	156.625	●		For inter-ship communications, fixed at 1W
73	156.675	156.675	●		
74	156.725	156.725	●		Fixed at 1W
75	156.775	156.775	●		Fixed at 1W
76	156.825	156.825	●		Fixed at 1W
77	156.875	156.875	●		For inter-ship communications, fixed at 1W
78	156.925	161.525		●	
1078	156.925	156.925	●		
2078		161.525	●		Transmission prohibited
79	156.975	161.575		●	
1079	156.975	156.975	●		
2079		161.575	●		Transmission prohibited
80	157.025	161.625		●	Digital data comm has priority.
81	157.075	161.675		●	Digital data comm has priority.
82	157.125	161.725		●	Digital data comm has priority.
83	157.175	161.775		●	Digital data comm has priority.
84	157.225	161.825		●	Digital data comm has priority.
85	157.275	161.875		●	Digital data comm has priority.
86	157.325	161.925		●	Digital data comm has priority.
87	157.375	157.375	●		
88	157.425	157.425	●		

## Specifications

### (5) Weather Channels (FCC Rule 47CER80.371(c) and 80.373(f))

CH	RX (MHz)	Notes
WX1	162.550	NOAA weather channel
WX2	162.400	NOAA weather channel
WX3	162.475	NOAA weather channel
WX4	162.425	NOAA weather channel
WX5	162.450	NOAA weather channel
WX6	162.500	NOAA weather channel
WX7	162.525	NOAA weather channel
WX8	161.650	CANADA CMB service
WX9	161.775	CANADA CMB service
WX0	163.275	NOAA weather channel (Assigned only)

### (6) Private Channels (For fishing or specially assigned channels)

CH	Simplex/Semi-duplex	Frequency (MHz)
P001 - P200	Common to both simplex and semi-duplex	155.0000 - 163.5000

#### Note

- Register the frequencies in 10kHz, 12.5kHz or 25kHz steps.
- If TX and RX frequencies are different, the equipment is in semi-duplex mode.
- Private channels are registered at the installation of the equipment. If desired to add the other private channels after installation, contact JRC or our agency.



## 9.3 Options

### (1) Controller (NCM-980)

Communication speed	125/ 250 kbps
Communication interface	CAN, IEC61162-450 Ed.2 (2018-05) (DIM)
Microphone input impedance	2.2 k $\Omega$ balanced (NQW-980 use)
Standard modulation input	-40 dBm
Audio output	Internal loudspeaker (4 $\Omega$ ): Max. 6 W or more Handset phone (150 $\Omega$ ): Max. 1 mW or more
LCD	5-inch TFT color, 800x480 pixels, LED backlight Maximum brightness 1000 cd/m <sup>2</sup>
Operation buttons	Touch panel, power button, DISTRESS button, volume control, SQ control
Dimensions and mass	240 mm(W) $\times$ 96 mm(H) $\times$ 54 mm(D) [excluding projections] Approx. 0.9 kg

### (2) AC/DC power supply (NBD-965)

Source voltage	100 VAC - 240 VAC (50/60 Hz) and 24 VDC
Output voltage	AC Operation: 24 VDC (23.04 VDC - 24.96 VDC) DC Operation: 24 VDC (varies with input voltage)
Maximum output current	6.6 A
Source switching function	If AC is off, automatically changed to DC. (uninterrupted) If AC is restored, automatically changed to AC operation.
Temperature range for full performance	-25 $^{\circ}$ C - +60 $^{\circ}$ C
Operating temperature	-25 $^{\circ}$ C - +60 $^{\circ}$ C
Storage temperature	-30 $^{\circ}$ C - +70 $^{\circ}$ C
Humidity resistance	93 % at +40 $^{\circ}$ C with no condensation
Vibration resistance (3 axes)	2 Hz - 15.8 Hz Amplitude $\pm$ 1 mm 15.8 Hz - 100 Hz Acceleration 1 G No abnormality after testing resonance points or at 30 Hz for more than 2 hours.
Continuous operation	No abnormality after operating continuously for 8 hours

### (3) Printer (RP-D10)

Printing system	Thermal line system
Communication interface	Ethernet (10Base-T/100Base-TX)
Data buffer	4096 bytes
Maximum print speed	200 mm/sec
Roll paper width	80 mm
Power voltage	24 VDC $\pm$ 5 %
Current consumption	Max. 3.9 A

## 9.4 Peripheral interfaces

### (1) GPS or other navigation aids interface

Serial	Interface standard	NMEA0183/IEC61162-1 Ed.5 (2016) compliant	
	Protocol	4800 bps, start 1 bit, data 8 bit, stop 1 bit, non parity	
LAN	Interface standard	IEC61162-450 Ed.2 (2018-05) compliant	
Input sentence		NMEA0183	V1.5: GGA/ GLL/ RMC V2.0: GGA/ GLL/ RMC/ ZDA V2.3: GGA/ GLL/ RMC/ GNS/ ZDA (Talker = "GP" or other)
Data type		Ship position & time:	GGA/ GNS/ GLL/ RMC
		Date:	ZDA/ RMC
		Current clock time:	ZDA/ GGA/ GNS/ GLL/ RMC

#### (1.1) Interface circuits (NMEA0183/IEC61162-1)

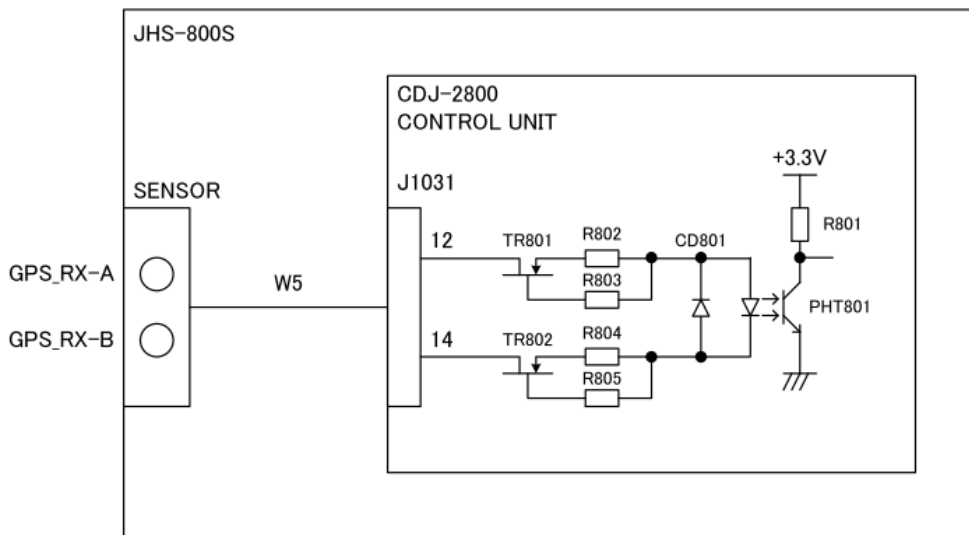

■ Load requirements

Current consumption: 2 mA at 2 V or less

Maximum input voltage: ±15 V or more

Recommended operating current: 2 mA or more

(1.2) List of sentences and associated data fields

(1.2.1) GGA – Global positioning system (GPS) fix data

---

\$--GGA, hhhmss, llll.ll, a, yyyy.yy, a, x, xx, x.x, x.x, M, x.x, M, x.x, xxxx \*hh<CR><LF>

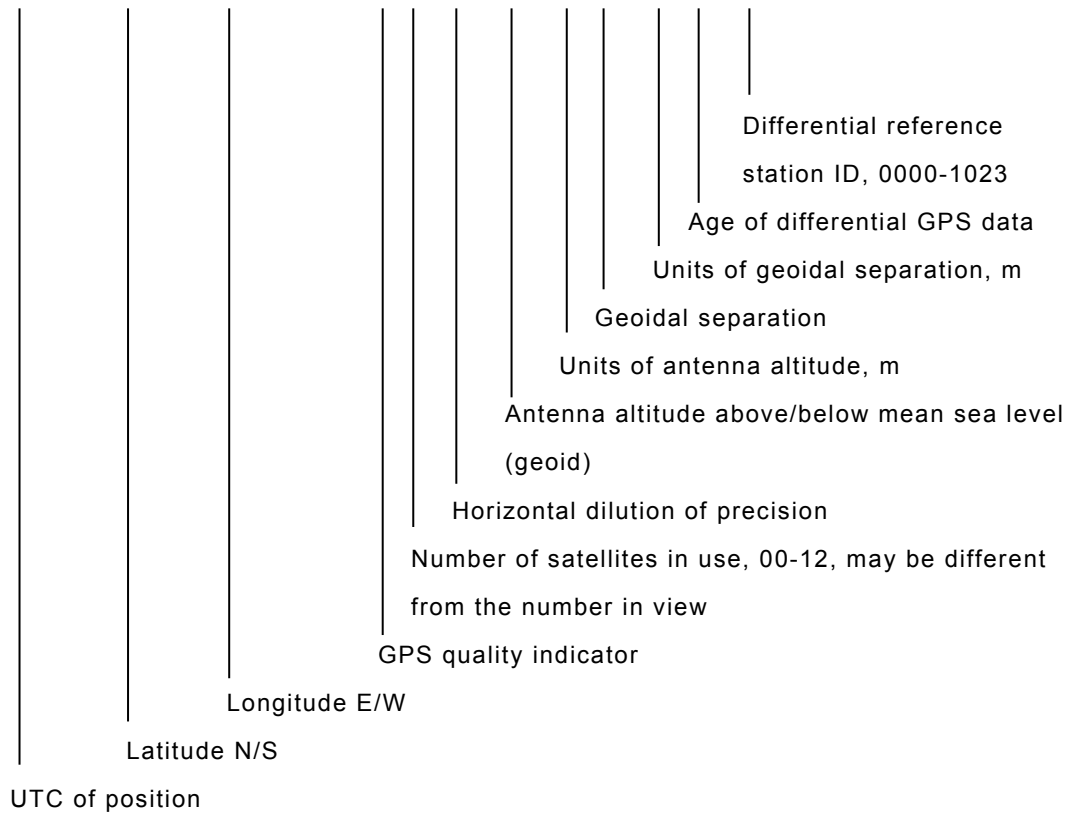

(1.2.2) GLL – Geographic position – Latitude/longitude

---

\$--GLL, llll.ll, a, yyyy.yy, a, hhhmss.ss, A, a \*hh<CR><LF>

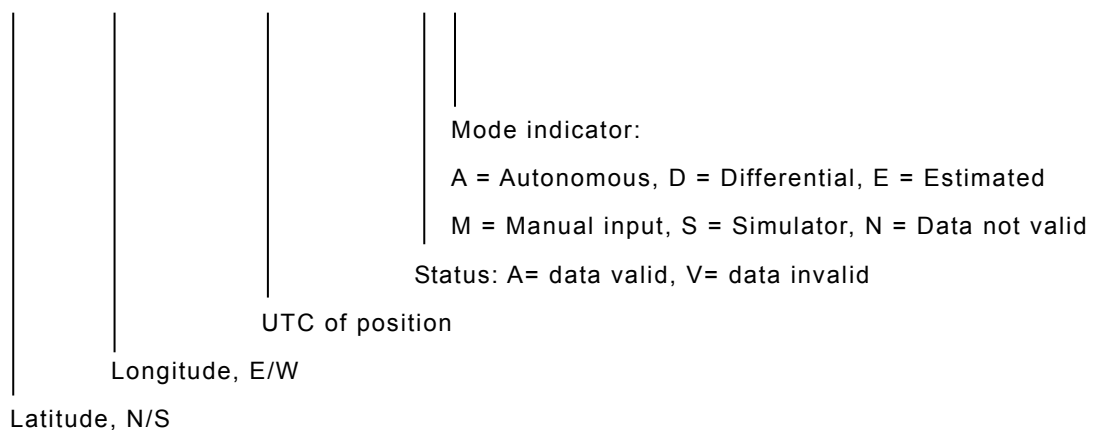



(1.2.5) ZDA – Time and date

---

\$--ZDA, hhmmss.ss, xx, xx, xxxx, xx, xx \*hh<CR><LF>

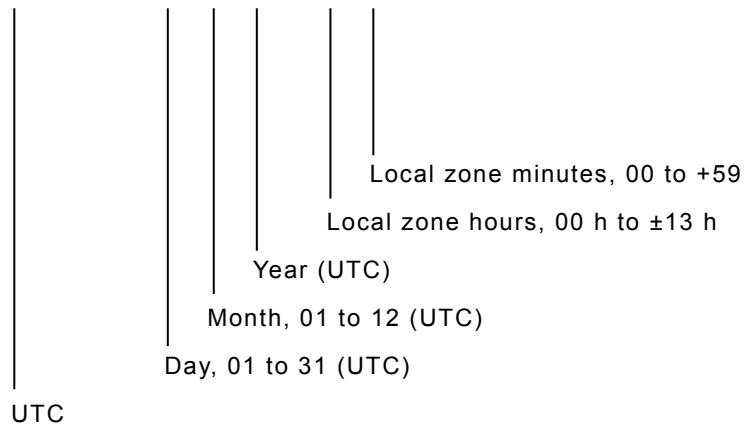

## Specifications

### (1.3) Indication about the positioning system and the quality type

#### 1) Indication for GGA sentence

QI	Description	Device	Operating state		Quality	
			Positioning	Quality	Valid	Invalid
0	Fix not available or invalid	GPS	GPS	INVALID		●
		GLONASS	GL	INVALID		●
		Galileo	GA	INVALID		●
		Other	OTH	INVALID		●
1	SPS (Standard Positioning Service) mode	GPS	GPS	STD	●	
		GLONASS	GL	STD	●	
		Galileo	GA	STD	●	
		Other	OTH	STD	●	
2	Differential mode	GPS	GPS	DGPS	●	
		GLONASS	GL	DGL	●	
		Galileo	GA	DGA	●	
		Other	OTH	DOTH	●	
3	PPS (Precise Positioning Service) mode	GPS	GPS	PREC	●	
		GLONASS	GL	PREC	●	
		Galileo	GA	PREC	●	
		Other	OTH	PREC	●	
4	RTK (Real Time Kinematic) mode	GPS	GPS	RTK	●	
		GLONASS	GL	RTK	●	
		Galileo	GA	RTK	●	
		Other	OTH	RTK	●	
5	FRTK (Float Real Time Kinematic) mode	GPS	GPS	FRTK	●	
		GLONASS	GL	FRTK	●	
		Galileo	GA	FRTK	●	
		Other	OTH	FRTK	●	
6	Estimated (dead reckoning) mode	GPS	GPS	EST		●
		GLONASS	GL	EST		●
		Galileo	GA	EST		●
		Other	OTH	EST		●
7	Manual input mode	GPS	GPS	MAN		●
		GLONASS	GL	MAN		●
		Galileo	GA	MAN		●
		Other	OTH	MAN		●
8	Simulator mode	GPS	GPS	SIM		●
		GLONASS	GL	SIM		●
		Galileo	GA	SIM		●
		Other	OTH	SIM		●

#### Note

When receiving the GGA sentence, the quality type is checked using the Quality Indicator (QI) as mentioned in the table above.

- If the quality is valid, the operating state is indicated with the position and time information.
- If the quality is invalid, the next GNS sentence is referred.

## 2) Indication for GNS sentence

Device	MI	Description	Operating state		Quality	
			Positioning	Quality	Valid	Invalid
GPS	A	Autonomous mode	GPS	STD	●	
	D	Differential mode	GPS	DGPS	●	
	E	Estimated (dead reckoning) mode	GPS	EST		●
	F	FRTK (Float Real Time Kinematic) mode	GPS	FRTK	●	
	M	Manual input mode	GPS	MAN		●
	N	No Fix	GPS	INVALID		●
	P	PPS (Precise Positioning Service) mode	GPS	PREC	●	
	R	RTK (Real Time Kinematic) mode	GPS	RTK	●	
	S	Simulator mode	GPS	SIM		●
GLONASS	A	Autonomous mode	GL	STD	●	
	D	Differential mode	GL	DGL	●	
	E	Estimated (dead reckoning) mode	GL	EST		●
	F	FRTK (Float Real Time Kinematic) mode	GL	FRTK	●	
	M	Manual input mode	GL	MAN		●
	N	No Fix	GL	INVALID		●
	P	PPS (Precise Positioning Service) mode	GL	PREC	●	
	R	RTK (Real Time Kinematic) mode	GL	RTK	●	
	S	Simulator mode	GL	SIM		●
Galileo	A	Autonomous mode	GA	STD	●	
	D	Differential mode	GA	DGA	●	
	E	Estimated (dead reckoning) mode	GA	EST		●
	F	FRTK (Float Real Time Kinematic) mode	GA	FRTK	●	
	M	Manual input mode	GA	MAN		●
	N	No Fix	GA	INVALID		●
	P	PPS (Precise Positioning Service) mode	GA	PREC	●	
	R	RTK (Real Time Kinematic) mode	GA	RTK	●	
	S	Simulator mode	GA	SIM		●
上記以外	A	Autonomous mode	OTH	STD	●	
	D	Differential mode	OTH	DOTH	●	
	E	Estimated (dead reckoning) mode	OTH	EST		●
	F	FRTK (Float Real Time Kinematic) mode	OTH	FRTK	●	
	M	Manual input mode	OTH	MAN		●
	N	No Fix	OTH	INVALID		●
	P	PPS (Precise Positioning Service) mode	OTH	PREC	●	
	R	RTK (Real Time Kinematic) mode	OTH	RTK	●	
	S	Simulator mode	OTH	SIM		●

**Note**

When receiving the GNS sentence, and if the Navigational status in that sentence is S (Safe), the quality type is checked using the Mode Indicator (MI) as mentioned in the table above.

- If the quality is valid, the operating state is indicated with the position and time information.
- If the quality is invalid, or the Navigational status is C (Caution), U (Unsafe) or V (Not valid), the next GLL sentence is referred.

## Specifications

### 3) Indication for GLL sentence

MI	Description	Device	Operating state		Quality	
			Positioning	Quality	Valid	Invalid
A	Autonomous mode	GPS	GPS	STD	●	
		GLONASS	GL	STD	●	
		Galileo	GA	STD	●	
		Other	OTH	STD	●	
D	Differential mode	GPS	GPS	DGPS	●	
		GLONASS	GL	DGL	●	
		Galileo	GA	DGA	●	
		Other	OTH	DOTH	●	
E	Estimated (dead reckoning) mode	GPS	GPS	EST		●
		GLONASS	GL	EST		●
		Galileo	GA	EST		●
		Other	OTH	EST		●
M	Manual input mode	GPS	GPS	MAN		●
		GLONASS	GL	MAN		●
		Galileo	GA	MAN		●
		Other	OTH	MAN		●
S	Simulator mode	GPS	GPS	SIM		●
		GLONASS	GL	SIM		●
		Galileo	GA	SIM		●
		Other	OTH	SIM		●
N	No Fix	GPS	GPS	INVALID		●
		GLONASS	GL	INVALID		●
		Galileo	GA	INVALID		●
		Other	OTH	INVALID		●

#### Note

When receiving the GLL sentence, and if the Status in that sentence is A (Data valid), the quality type is checked using the Mode Indicator (MI) as mentioned in the table above.

- If the quality is valid, the operating state is indicated with the position and time information.
- If the quality is invalid, or the Status is V (Data invalid), the next RMC sentence is referred.



## 4) Indication for RMC sentence

MI	Description	Device	Operating state		Quality	
			Positioning	Quality	Valid	Invalid
A	Autonomous mode	GPS	GPS	STD	●	
		GLONASS	GL	STD	●	
		Galileo	GA	STD	●	
		Other	OTH	STD	●	
D	Differential mode	GPS	GPS	DGPS	●	
		GLONASS	GL	DGL	●	
		Galileo	GA	DGA	●	
		Other	OTH	DOTH	●	
E	Estimated (dead reckoning) mode	GPS	GPS	EST		●
		GLONASS	GL	EST		●
		Galileo	GA	EST		●
		Other	OTH	EST		●
F	FRTK (Float Real Time Kinematic) mode	GPS	GPS	FRTK	●	
		GLONASS	GL	FRTK	●	
		Galileo	GA	FRTK	●	
		Other	OTH	FRTK	●	
M	Manual input mode	GPS	GPS	MAN		●
		GLONASS	GL	MAN		●
		Galileo	GA	MAN		●
		Other	OTH	MAN		●
N	No Fix	GPS	GPS	INVALID		●
		GLONASS	GL	INVALID		●
		Galileo	GA	INVALID		●
		Other	OTH	INVALID		●
P	PPS (Precise Positioning Service) mode	GPS	GPS	PREC	●	
		GLONASS	GL	PREC	●	
		Galileo	GA	PREC	●	
		Other	OTH	PREC	●	
R	RTK (Real Time Kinematic) mode	GPS	GPS	RTK	●	
		GLONASS	GL	RTK	●	
		Galileo	GA	RTK	●	
		Other	OTH	RTK	●	
S	Simulator mode	GPS	GPS	SIM		●
		GLONASS	GL	SIM		●
		Galileo	GA	SIM		●
		Other	OTH	SIM		●

**Note**

When receiving the RMC sentence, and if the Status in that sentence is A (Data valid) and the Navigational status is S (Safe), the quality type is checked using the Mode Indicator (MI) as mentioned in the table above.

- If the quality is valid, the operating state is indicated with the position and time information.
- If the quality is invalid, or if the Status is V (Data invalid) or the Navigational status is C (Caution), U (Unsafe) or V (Not valid), the operating state decided by the Quality Indicator, Status or Mode indicator of the receiving highest priority sentence (GGA> GNS> GLL> RMC) is displayed on the screen.

Specifications

(2) AIS interface

Serial	Interface standard	IEC61162-2 Ed.1 (1998-09) compliant
	Protocol	38.4kbps, start 1bit, data 8bit, stop 1bit, Non parity
LAN	Interface standard	IEC61162-450 Ed.2 (2018-05) compliant
Input sentence/message	VDM sentence:	VDL1-5, 9, 18, 19
	VDO sentence:	VDL1-3, 18
	ALR sentence:	003, 004, 026, 062, 065
	(Talker = "AI" only)	
Data type	Name and identification number of other ship Position information of other ship AIS type (Class A/B/Base station, SAR) Position data for own ship	

(2.1) Interface circuits (IEC61162-2)

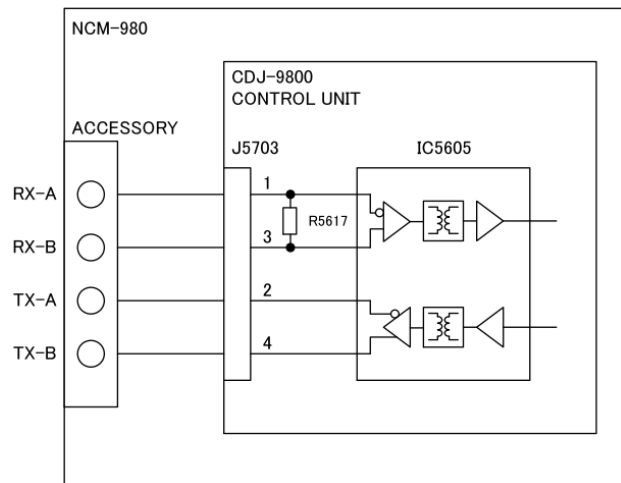
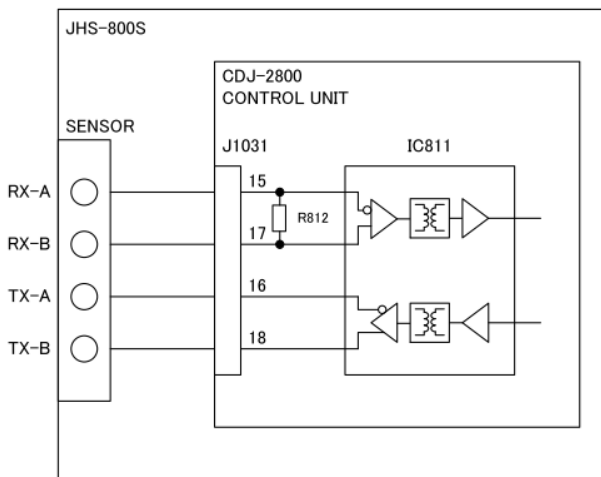

(NCM-980 peripheral devices are only DIM.)

■ Electric characteristic

<RX>

Input Current:  $\pm 70$  mA at  $\pm 7$  V

Maximum differential input voltage:  $\pm 15$  V or more

<TX>

Maximum differential output voltage:  $\pm 3.6$  V

Maximum output current: 200 mA

## (3) RMS interface

LAN	Interface standard	IEC61162-450 Ed.2 (2018-05) compliant
Output message		IEC61162-1 Ed.4 (2010-11) compliant proprietary sentence \$PJRCCL sentence (for RMS log saving) \$PJRCM sentence (Device ID = "CV")
Data type		Model number, serial number, self-diagnosis, etc.

## (4) BAM/MFD interface

LAN	Interface standard	IEC61162-450 Ed.2 (2018-05) compliant
Input / Output sentence		ALF: Outputs the state of an alert such as start, normal, etc. Note) Manufacturer Mnemonic code is null or JRC. ALC: Outputs the states of all alerts every 20 seconds. ACN: Inputs requests from the CAM such as ACK, silence etc. ARC: Outputs the refusal to the request by the ACN sentence. HBT: Inputs the connection condition from the CAM during the responsibility transfer. Note) If no reception in 100 sec, the responsibility transfer state is broken and the alert control is returned.
Data type		BAM alert state

## (5) DIM interface

Serial	Interface standard	IEC61162-2 Ed.1 (1998-09) compliant
	Protocol	38.4kbps, start 1bit, data 8bit, stop 1bit, non parity
LAN	Interface standard	IEC61162-450 Ed.2 (2018-05) compliant
Input / Output sentence		DDC sentence (Talker = "NL" or other, Device ID = "CV")
Data type		LCD backlight brightness

## 9.5 Software license information

This equipment includes the software where the GNU General Public License (GPL) is applicable. Our customers who desire to do so can obtain, modify or redistribute the source code of the applicable software.

To obtain the source code, please contact us at the following e-mail address.

E-mail address: [tmsc@jrc.co.jp](mailto:tmsc@jrc.co.jp)  
E-mail title: Request for source code based on the GPL  
Necessary information: 1. Product name 2. Model number 3. Serial number  
4. Customer's company name and office location  
5. Vessel name or IMO number  
6. Message text, for example as follows;  
"Send us the source code of the target software of the product mentioned above."

NOTE1: Customer is responsible for the cost concerning providing the source code.

NOTE2: The source code is WITHOUT ANY WARRANTY. And also, we cannot respond to any questions concerning the GPL source codes.

## 10. OPTIONS OPERATION

### 10.1 Handset connection box (NQE-1845B/1846/1847B)

There are three types of handset connection boxes: a waterproof flush mount type for a wing console (NQE-1845B), a waterproof wing installation type (NQE-1846) and an indoor flush mount type (NQE-1847B).



## CAUTION



Close the water-resistant cap of the waterproof type handset box after use. Rain and sea breeze could cause connector malfunction. Also do not leave the handset above deck.

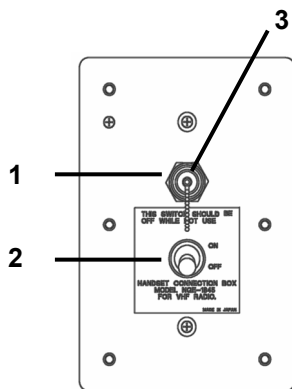

Waterproofed  
flush mount type  
for wing console  
(NQE-1845B)

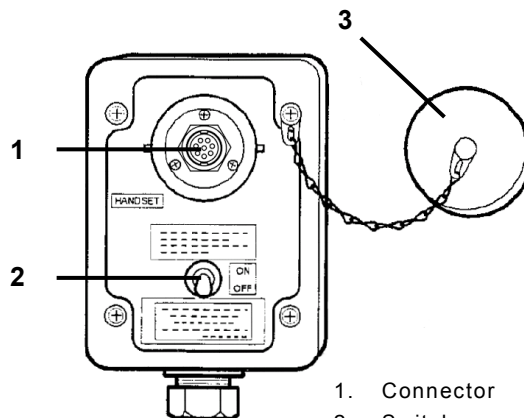

Waterproofed  
wing installation type  
(NQE-1846)

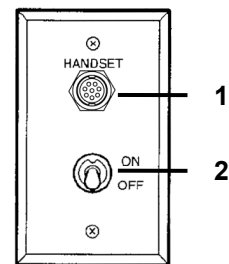

Indoor flush mount type  
(NQE-1847B)

1. Connector
2. Switch
3. Waterproof cap

#### ■ Procedure ■

1. In the case of the waterproof type, remove the water-resistant cap.
2. Connect the handset (NQW-980) to the connector.
3. Turn ON the switch to start communications.

The access right is obtained by turning on this switch.

(This switch is equivalent to hook switch of the handset.)

#### Note

- Always turn off the switch when not in use.
- Even if the switch is turned on, while another controller with higher priority is in use, the access right will not be obtained.

## 10.2 AC/DC power supply (NBD-965)

### **WARNING**



Before replacing fuses of the AC/DC POWER SUPPLY (NBD-965), always turn off the AC/DC power switch and power source output to this unit.



Always use the specified fuse when replacing a fuse. Using a different fuse may result in fire or malfunction.

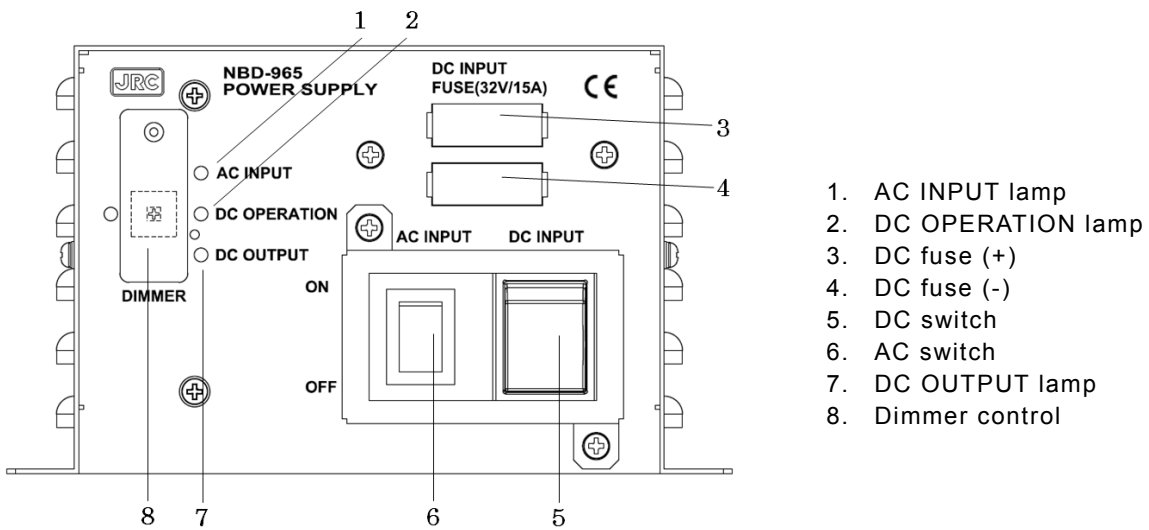

### ■ Procedure ■

1. Turn on both of the AC and DC switches.

If there is no AC power connected, turn on the DC power switch only.

2. Confirm that the DC OUTPUT lamp is lit.

If this lamp is on, 24VDC power is being output properly.

#### Note

- If the switch is turned on the DC OUTPUT lamp does not light, except for the dimmer control position, there may be a malfunction with the AC/DC input power voltage, or a fuse may have been blown.
- If only DC power is used, the DC OPERATION lamp turns on. Be careful not to over discharge the battery.

## 10.3 Printer (RP-D10)



### CAUTION



The thermal head of the printer may be very hot after printing. Do not touch it. Perform paper replacement and head cleaning only after waiting for the head to completely cool.



Do not put your finger etc. because there is a cutter blade at the paper discharge port. Also, do not touch the blade of the cutter when opening the paper cover.



The printing paper used in this printer is a heat sensitive paper. Take the following precautions when using this paper.

- Store the paper away from heat, humidity, or heat sources.
- Do not rub the paper with any hard objects.
- Do not place the paper near organic solvents.
- Do not allow the paper to come in contact with polyvinyl chloride film, erasers, or adhesive tape for long periods of time.
- Keep away the paper from freshly copied diazo type or wet process copy paper.

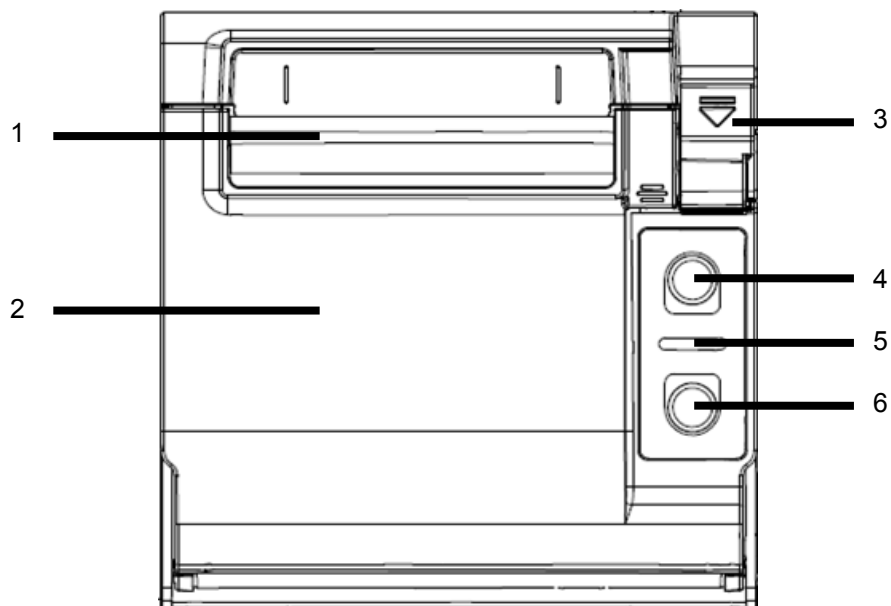

1. Paper slit
2. Roll paper cover
3. Release lever
4. Feed button
5. LED lamp
6. Power switch

## ■ Turning the power on / off ■

When the external power is supplied to the NBG-980 Power supply connected to the printer, the printer is turned on immediately.

- To turn off the printer, press and hold the power switch for more than 5 seconds.
- When turning on the printer again after turning off using the power switch, press and hold the power switch until the LED lights up in orange. After lighting up, the LED turns off immediately but the power is ON.

## ■ Loading the printer paper ■

- 1.** Pull the release lever.

The paper cover is opened.

- 2.** Insert the paper as shown at right.

Position the paper such that the edge extends outside the printer, and press the both sides of the paper cover to close it. When the paper cover is closed, paper feed and cutting of the leading edge of the paper are done automatically.

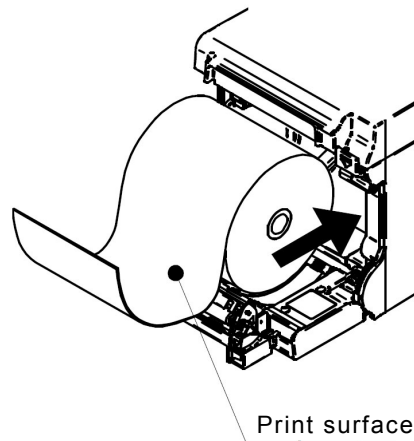



## 10.4 Remote control from ECDIS or Marine radar

The equipment is connectable to the ECDIS model JAN-7200/ 9200 series or the Marine radar model JMR-7200/ 9200 series and the remote control such as the channel setting and DSC calls from them are available.

NOTE: For details of environmental settings, refer to the manual of the ECDIS or the Marine radar.

### ■ VHF Call dialog ■

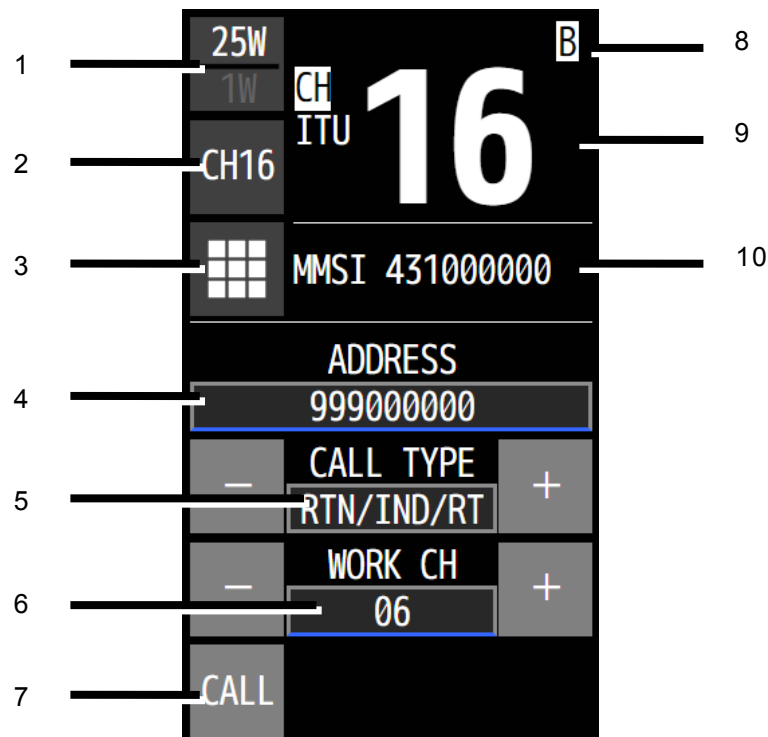

1. Transmission power changing button (25W/1W)
2. Priority channel (CH16) setting button
3. Ten-key icon button
4. Receiver address (MMSI) entry field
5. DSC call type selector
6. Working channel entry field
7. DSC call transmission button
8. Bluetooth pairing indicator
9. Channel information display
10. Own ship's ID (MMSI) indicator

## ■ Making a DSC call ■

The following describes the procedure to make a call from the screen of the ECDIS or Marine radar.

1. Right-click the AIS target on the ECDIS chart or Marine radar PPI to open the context menu, and then click the VHF Call on it.

- Using the MMSI obtained from the AIS target, the VHF Call dialog as shown at right is displayed.
- The working channel is automatically selected.
- The DSC call type and/or the working channel can be changed manually, if required.
- The category of the DSC call type is restricted to either safety or routine.

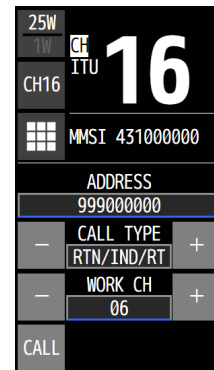

2. Click the CALL button to transmit the DSC call.

After checking the free channel, the equipment transmits the DSC call and then starts waiting for the acknowledgement.

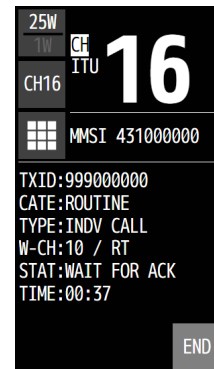

3. When the acknowledgement is received, the working channel is set automatically and the screen as shown at right is displayed.

- Start communications using the handset or the wireless speaker microphone.
- When completed the communications, click the END button. And then, click the CH16 button to return to the CH16.

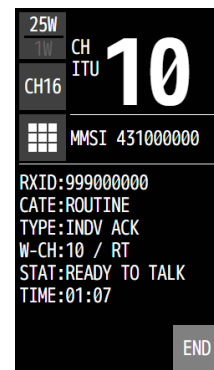

**Note**

- While the main unit or the controller is in use, this VHF remote control screen may display the message that the remote control function is not available. In this case, retry the operation after completed the operation on the main unit or the controller.
- When calling a receiver station on the CH16 using radiotelephony and after that changing to another working channel, click the ten-key icon button and use the numeric keypad at right to set the channel.
- To return from the screen at right to the DSC menu screen, click the DSC OPE button.

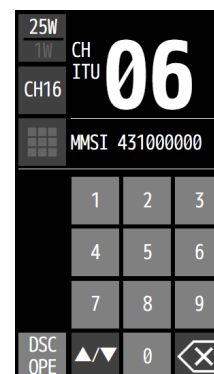

## Marking with market circulation mark

We Japan Radio Co., Ltd. declare that the JRC VHF JHS-800S corresponds with Technical regulations concerning the safety of sea transport facilities (approved by the Russian Federal Government in its Order No. 620 of August 12, 2010).

### 1. Products Classification (Annex 1 to Technical regulations concerning the safety of sea transport facilities)

All Russian Products Classification Code	Designation of technical regulation item	Regulations of 1974* Convention, Resolutions and Circulars of International Maritime Organization which should be met by technical regulation items
------------------------------------------	------------------------------------------	-----------------------------------------------------------------------------------------------------------------------------------------------------

6481100	VHF Receiver (radio installation) capable of DSC transmitting and receiving on channel 70	Reg. IV/14, Reg. X/3 Resolution MSC.36 (63), Paragraph 14.13.1 of HSC Code, 1994* (9) Resolution MSC.97 (73), Reg. 13.17.1 of HSC Code, 2000* (2) Reg. IV/7.1.2, Paragraph 14.6.1.2 of HSC Code, 1994* (9) Resolution MSC.97 (73), Paragraph 14.7.1.2 of HSC Code, 2000* (2) Resolution A.803 (19), Annex 1 to Resolution MSC.68 (68), Resolution A.694 (17)
---------	-------------------------------------------------------------------------------------------	-----------------------------------------------------------------------------------------------------------------------------------------------------------------------------------------------------------------------------------------------------------------------------------------------------------------------------------------------------------------------------------------------

\* International Convention for the Prevention of Pollution from Ships as Modified by the Protocol of 1978 1978 Relating Thereto (Convention, 1973);

### 2. Present procedures for products intended for operation in the territory of the Russian Federation for ships entitled to fly the flag of the Russian Federation:

2.1 Warning signs (Warning Labels) to be made in the Russian language.

2.2 The products labeled with a conformity mark, as prescribed by the Russian Federation laws concerning technical regulation (The Russian Federation Government Order "On Conformity Mark" No. 696 of 19 November 2003).

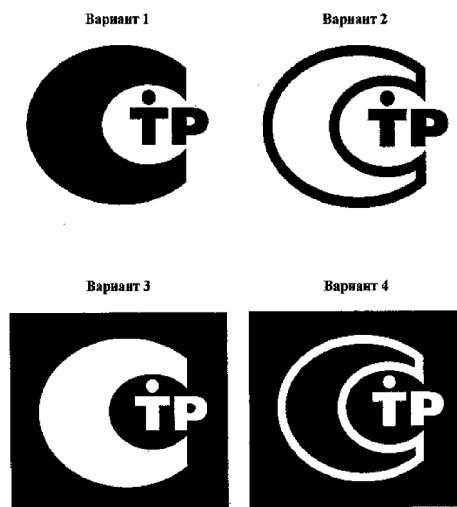

2.3 Disposal (utilization) of products should be made in conjunction with the ship on a single technology or separately in accordance with the Federal Law of the Russian Federation No.89 FZ "On Waste of Production and Consumption".



## 电子信息产品有害物资申明

日本无线株式会社

### Declaration on toxic & hazardous substances or elements of Electronic Information Products Japan Radio Company Limited

#### 有毒有害物质或元素的名称及含量

(Names & Content of toxic and hazardous substances or elements)

形式名(Type): JHS-800S

名称(Name): Marine VHF Radiotelephone

部件名称 (Part name)	有毒有害物质或元素 (Toxic and Hazardous Substances and Elements)					
	铅 (Pb)	汞 (Hg)	镉 (Cd)	六价铬 (Cr <sup>6+</sup> )	多溴联苯 (PBB)	多溴二苯醚 (PBDE)
天线 (Antenna)	×	○	×	×	×	×
船内装置 (Inboard Unit)	×	○	×	×	×	×
外部设备(Peripherals) ·选择(Options) ·打印机(Printer) ·电线类(Cables) ·手册(Documentnts)	×	○	×	×	×	×
<p>○:表示该有毒有害物质在该部件所有均质材料中的含量均在SJ/T11306-2006 标准规定的限量要求以下。 (Indicates that this toxic, or hazardous substance contained in all of the homogeneous materials for this part is below the requirement in SJ/T11363-2006.)</p> <p>×:表示该有毒有害物质至少在该部件的某一均质材料中的含量超出SJ/T11363-2006 标准规定的限量要求。 (Indicates that this toxic or hazardous substance contained in at least one of the homogeneous materials used for this part is above the limit requirement in SJ/T 11363-2006.)</p>						

RE: 中华人民共和国电子信息产品污染控制管理办法  
Management Methods on Control of Pollution from Electronics Information Products of the People's Republic of China





アスベストは使用していません  
Not use the asbestos

*For further information, contact:*

**JRC** *Japan Radio Co., Ltd.*

*Since 1915*

URL Head office : <http://www.jrc.co.jp/eng/>

Marine Service Department

1-7-32 Tatsumi, Koto-ku, Tokyo 135-0053, Japan

e-mail : [tmsc@jrc.co.jp](mailto:tmsc@jrc.co.jp)

One-call : +81-50-3786-9201

ISO 9001, ISO 14001 Certified